

NOTICE

Note that when converting this document from its original format to a .pdf file, some minor font and format changes may occur. When viewing and printing this document, we cannot guarantee that your specific PC or printer will support all of the fonts or graphics. Therefore, when you view the document, fonts may be substituted and your individual printer may not have the capability to print the document correctly.

UNIVERGE[®] SV8100

Programming Manual

NEC Unified Solutions, Inc. reserves the right to change the specifications, functions, or features at any time without notice.

NEC Unified Solutions, Inc. has prepared this document for use by its employees and customers. The information contained herein is the property of NEC Unified Solutions, Inc. and shall not be reproduced without prior written approval of NEC Unified Solutions, Inc.

D^{term} is a registered trademark of NEC Corporation. UNIVERGE is a registered trademark of NEC Corporation. Windows is a registered trademark of Microsoft Corporation.

Copyright 2009

**NEC Infrontia, Inc.
6535 N. State Highway 161
Irving, TX 75039-2402**

Technology Development

Preface

THIS MANUAL

The Programming Manual provides the technician with all of the necessary information for programming the UNIVERGE SV8100 system.

Programming can be accomplished using a PC or a multiline terminal.

SUPPORTING DOCUMENTS

UNIVERGE SV8100 General Description Manual

This Manual provides general information about the system, its features, system configuration and standards. This manual provides an overview of the UNIVERGE SV8100 system and can be used to present information to potential customers.

UNIVERGE SV8100 System Hardware Manual

The System Hardware Manual is provided for the system installer. This manual has detailed instructions for installing the SV8100 chassis, blades, multiline terminals, and optional equipment.

UNIVERGE SV8100 Features and Specifications Manual

This manual provides detailed information for each of the system features. If you are not familiar with the features, the Table of Contents lists each of the features and where to find the feature within the manual.

UNIVERGE SV8100 Networking Manual

This manual provides information on networking the SV8100 using K-CCIS, IP K-CCIS, and NetLink.

UNIVERGE SV8100 PC Programming Manual

This manual provides information on installing and using the application that allows programming the SV8100 system via a computer.

TABLE OF CONTENTS

Chapter 1 Introduction

Section 1	Before You Start Programming	1-1
Section 2	How to Use This Manual	1-1
Section 3	How to Enter Programming Mode	1-2
Section 4	How to Exit Programming Mode	1-3
Section 5	Using Keys to Move Around in the Programs	1-4
Section 6	Programming Names and Text Messages	1-5
Section 7	Using Softkeys For Programming	1-6
Section 8	What the Softkey Display Prompts Mean	1-7
Section 9	System Number Plan/Capacities	1-8

Chapter 2 Programming the UNIVERGE SV8100

Section 1	Programming Your System	2-1
	Program 10 : System Configuration Setup	
	10-01 : Time and Date	2-3
	10-02 : Location Setup	2-4
	10-03 : ETU Setup	2-5
	10-04 : Music On Hold Setup	2-16
	10-05 : General Purpose Relay Setup	2-18
	10-06 : ISDN-BRI Setup	2-19
	10-08 : Pre-Ringing Setup	2-20
	10-09 : DTMF and Dial Tone Circuit Setup	2-21
	10-12 : CD-CP00-US Network Setup	2-23
	10-13 : In-DHCP Server Setup	2-26

10-14 : Managed Network Setup	2-27
10-15 : Client Information Setup	2-28
10-16 : Option Information Setup	2-29
10-17 : H.323 Gatekeeper Setup	2-33
10-18 : H.323 Alias Address Setup	2-34
10-19 : VoIP DSP Resource Selection	2-35
10-20 : LAN Setup for External Equipment	2-36
10-21 : CD-CP00-US Hardware Setup	2-38
10-23 : SIP System Interconnection Setup	2-39
10-24 : Daylight Savings Setup	2-40
10-25 : H.323 Gateway Prefix Setup	2-42
10-26 : IP System Operation Setup	2-43
10-28 : SIP System Information Setup	2-44
10-29 : SIP Server Information Setup	2-46
10-30 : SIP Authentication Information Setup	2-49
10-33 : SIP Registrar/Proxy Information Basic Setup	2-50
10-36 : SIP Trunk Registration Information Setup	2-52
10-37 : UPnP Setup	2-53
10-38 : BGM Resource Setup	2-54
10-39 : Fractional Setup	2-55
10-40 : IP Trunk Availability	2-56
10-42 : Virtual Loop Back Port Setting	2-57
10-45 : IP Routing Table Setup	2-58
10-46 : DT700 Server Information Setup	2-59
10-47 : Terminal License Server Information Setup	2-62
10-48 : License Activation	2-63
10-49 : License File Activation	2-64
10-50 : License Information	2-65
10-51 : PRI/T1 Selection of CD-PRTA	2-69
10-52 : Free/Demo License Information	2-70
10-54 : License Configuration for Each Package	2-71
10-55 : Package Network Setup	2-72

10-56 : XML Portal IP Phone	2-74
10-58 : Network Address	2-75

Program 11 : System Numbering

11-01 : System Numbering	2-77
11-02 : Extension Numbering	2-85
11-04 : Virtual Extension Numbering	2-87
11-06 : ACI Extension Numbering	2-89
11-07 : Department Group Pilot Numbers	2-90
11-08 : ACI Group Pilot Number	2-91
11-09 : Trunk Access Code	2-92
11-10 : Service Code Setup (for System Administrator)	2-94
11-11 : Service Code Setup (for Setup/Entry Operation)	2-97
11-12 : Service Code Setup (for Service Access)	2-101
11-13 : Service Code Setup (for ACD)	2-105
11-14 : Service Code Setup (for Hotel)	2-107
11-15 : Service Code Setup, Administrative (for Special Access)	2-109
11-16 : Single Digit Service Code Setup	2-111
11-17 : ACD Group Pilot Number	2-113
11-20 : Dial Extension Analyze Table	2-114

Program 12 : Night Mode Setup

12-01 : Night Mode Function Setup	2-115
12-02 : Automatic Night Service Patterns	2-116
12-03 : Weekly Night Service Switching	2-118
12-04 : Holiday Night Service Switching	2-120
12-05 : Night Mode Group Assignment for Extensions	2-121
12-06 : Night Mode Group Assignment for Trunks	2-122
12-07 : Text Data for Night Mode	2-123
12-08 : Night Mode Service Range	2-124

Program 13 : Abbreviated Dialing

13-01 : Speed Dialing Function Setup	2-125
13-02 : Group Speed Dialing Bins	2-126

13-03 : Speed Dialing Group Assignment for Extensions	2-127
13-04 : Speed Dialing Number and Name	2-128
13-05 : Speed Dial Trunk Group	2-130
13-07 : Telephone Book Dial Number and Name	2-131
13-08 : Telephone Book System Name	2-132
13-09 : Telephone Book Group Name	2-133
13-10 : Telephone Book Routing	2-134

Program 14 : Trunk, Basic Setup

14-01 : Basic Trunk Data Setup	2-135
14-02 : Analog Trunk Data Setup	2-141
14-04 : Behind PBX Setup	2-144
14-05 : Trunk Group	2-145
14-06 : Trunk Group Routing	2-146
14-07 : Trunk Access Map Setup	2-148
14-08 : Music on Hold Source for Trunks	2-150
14-09 : Conversation Recording Destination for Trunks	2-151
14-11 : ID Setup for IP Trunk	2-152
14-12 : SIP Register ID Setup for IP Trunk	2-153
14-13 : CCIS System Route ID	2-154
14-14 : CCIS Trunk CIC Assignment	2-155

Program 15 : Extension, Basic Setup

15-01 : Basic Extension Data Setup	2-157
15-02 : Multiline Telephone Basic Data Setup	2-159
15-03 : Single Line Telephone Basic Data Setup	2-167
15-05 : IP Telephone Terminal Basic Data Setup	2-170
15-06 : Trunk Access Map for Extensions	2-174
15-07 : Programmable Function Keys	2-175
15-08 : Incoming Virtual Extension Ring Tone Setup	2-185
15-09 : Virtual Extension Ring Assignment	2-187
15-10 : Incoming Virtual Extension Ring Tone Order Setup	2-188
15-11 : Virtual Extension Delayed Ring Assignment	2-190

15-12 : Conversation Recording Destination for Extensions	2-191
15-14 : Programmable One-Touch Keys	2-192
15-16 : SIP Register ID Setup for Extension	2-193
15-17 : CO Message Waiting Indication	2-194
15-18 : Virtual Extension Key Enhanced Options	2-195
15-19 : System Telephone Book Setup for Extension	2-196
15-20 : LCD Line Key Name Assignment	2-197
15-22 : Mobile Extension Setup	2-198
15-23 : Incoming Virtual Extension Large LED Setup	2-199
15-25 : DESI-less Page Setup	2-200

Program 16 : Department Group Setup

16-01 : Department Group Basic Data Setup	2-201
16-02 : Department Group Assignment for Extensions	2-204
16-03 : Secondary Department Group	2-205
16-04 : Call Restriction Between Department Groups	2-206

Program 20 : System Option Setup

20-01 : System Options	2-207
20-02 : System Options for Multiline Telephones	2-209
20-03 : System Options for Single Line Telephones	2-212
20-04 : System Options for Virtual Extensions	2-214
20-06 : Class of Service for Extensions	2-215
20-07 : Class of Service Options (Administrator Level)	2-216
20-08 : Class of Service Options (Outgoing Call Service)	2-219
20-09 : Class of Service Options (Incoming Call Service)	2-222
20-10 : Class of Service Options (Answer Service)	2-224
20-11 : Class of Service Options (Hold/Transfer Service)	2-226
20-12 : Class of Service Options (Charging Cost Service)	2-229
20-13 : Class of Service Options (Supplementary Service)	2-230
20-14 : Class of Service Options for DISA/E&M	2-235
20-15 : Ring Cycle Setup	2-237
20-16 : Selectable Display Messages	2-239

20-17 : Operator Extension	2-242
20-18 : Service Tone Timers	2-243
20-19 : System Options for Caller ID	2-245
20-20 : Message Setup for Non-Caller ID Data	2-246
20-21 : System Options for Long Conversation	2-247
20-22 : System Options for Wireless – DECT Service	2-248
20-23 : System Options for CTI	2-249
20-25 : ISDN Options	2-250
20-26 : Multiplier Changing CO	2-252
20-28 : Trunk to Trunk Conversation	2-253
20-29 : Timer Class for Extension	2-254
20-30 : Timer Class for Trunks	2-255
20-31 : Timer Class Timer Assignment	2-256
20-35 : Extension’s Operator Setting	2-260
20-36 : Trunk’s Operator Setting	2-261
20-37 : Operator Extension Group Setup	2-262
20-38 : Operator Group Setting	2-263

Program 21 : Outgoing Call Setup

21-01 : System Options for Outgoing Calls	2-265
21-02 : Trunk Group Routing for Extensions	2-269
21-03 : Trunk Group Routing for Trunks	2-270
21-04 : Toll Restriction Class for Extensions	2-271
21-05 : Toll Restriction Class	2-272
21-06 : Toll Restriction Table Data Setup	2-275
21-07 : Toll Restriction Override Password Setup	2-278
21-08 : Repeat Dial Setup	2-279
21-09 : Dial Block Setup	2-280
21-10 : Dial Block Restriction Class Per Extension	2-281
21-11 : Extension Ringdown (Hotline) Assignment	2-282
21-12 : ISDN Calling Party Number Setup for Trunks	2-283
21-13 : ISDN Calling Party Number Setup for Extensions	2-284
21-14 : Walking Toll Restriction Password Setup	2-285

21-15 : Individual Trunk Group Routing for Extensions	2-286
21-17 : IP Trunk (SIP) Calling Party Number Setup for Trunk	2-287
21-18 : IP Trunk (H.323) Calling Party Number Setup for Extension	2-288
21-19 : IP Trunk (SIP) Calling Party Number Setup for Extension	2-289
21-21 : Toll Restriction for Trunks (Seized Trunk Basis Setting)	2-290
21-22 : CO Message Waiting Indication – Call Back Settings	2-291

Program 22 : Incoming Call Setup

22-01 : System Options for Incoming Calls	2-293
22-02 : Incoming Call Trunk Setup	2-295
22-03 : Trunk Ring Tone Range	2-297
22-04 : Incoming Extension Ring Group Assignment	2-299
22-05 : Incoming Trunk Ring Group Assignment	2-300
22-06 : Normal Incoming Ring Mode	2-301
22-07 : DIL Assignment	2-302
22-08 : DIL/IRG No Answer Destination	2-303
22-09 : DID Basic Data Setup	2-304
22-10 : DID Translation Table Setup	2-306
22-11 : DID Translation Number Conversion	2-308
22-12 : DID Intercept Ring Group	2-312
22-13 : DID Trunk Group to Translation Table Assignment	2-314
22-14 : VRS Delayed Message for IRG	2-315
22-15 : VRS Delayed Message for Department Group	2-317
22-16 : Private Call Refuse Target Area Setup	2-319
22-17 : Dial-In Conversion Table Area Setup for Time Pattern	2-320
22-18 : Private Call Assignment Setup	2-321
22-20 : Flexible Ringing by Caller ID Setup	2-322

Program 23 : Answer Features Setup

23-02 : Call Pickup Groups	2-323
23-03 : Universal Answer/Auto Answer	2-324
23-04 : Ringing Line Preference for Virtual Extensions	2-326

Program 24 : Hold/Transfer Setup

24-01 : System Options for Hold	2-327
24-02 : System Options for Transfer	2-329
24-03 : Park Group	2-331
24-04 : Automatic Trunk-to-Trunk Transfer Target Setup	2-332
24-05 : Department Group Transfer Target Setup	2-333
24-06 : Fixed Call Forwarding	2-334
24-07 : Fixed Call Forward Off-Premise	2-335
24-08 : Call Forward for Centrex	2-336
24-09 : Call Forward Split Settings	2-337

Program 25 : VRS/DISA Setup

25-01 : VRS/DISA Line Basic Data Setup	2-339
25-02 : DID/DISA VRS Message	2-340
25-03 : VRS/DISA Transfer Ring Group With Incorrect Dialing	2-341
25-04 : VRS/DISA Transfer Ring Group With No Answer/Busy	2-342
25-05 : VRS/DISA Error Message Assignment	2-343
25-06 : VRS/DISA One-Digit Code Attendant Setup	2-344
25-07 : System Timers for VRS/DISA	2-346
25-08 : DISA User ID Setup	2-348
25-09 : Class of Service for DISA Users	2-349
25-10 : Trunk Group Routing for DISA	2-350
25-11 : DISA Toll Restriction Class	2-351
25-12 : Alternate Trunk Group Routing for DISA	2-352
25-13 : System Option for DISA	2-353
25-15 : DISA Transfer Target Setup	2-354

Program 26 : ARS Service

26-01 : Automatic Route Selection Service	2-357
26-02 : Dial Analysis Table for ARS/LCR	2-359
26-03 : ARS Dial Treatments	2-361
26-04 : ARS Class of Service	2-363
26-11 : Transit Network ID Table	2-364

26-12 : Network Specific Parameter Table for ARS	2-365
Program 30 : DSS/DLS Console Setup	
30-01 : DSS Console Operating Mode	2-367
30-02 : DSS Console Extension Assignment	2-368
30-03 : DSS Console Key Assignment	2-369
30-04 : DSS Console Alternate Answer	2-376
30-05 : DSS Console Lamp Table	2-377
30-10 : DSS Console IP Terminal Setup	2-379
Program 31 : Paging Setup	
31-01 : System Options for Internal/External Paging	2-381
31-02 : Internal Paging Group Assignment	2-383
31-03 : Internal Paging Group Settings	2-384
31-04 : External Paging Zone Group	2-387
31-05 : Universal Night Answer/Ring Over Page	2-388
31-06 : External Speaker Control	2-389
31-07 : Combined Paging Assignments	2-391
31-08 : BGM on External Paging	2-392
Program 32 : Door Box and Sensor Setup	
32-01 : Door Box Timers Setup	2-393
32-02 : Door Box Ring Assignment	2-394
32-03 : Door Box Basic Setup	2-395
32-04 : Door Box Name Setup	2-396
Program 33 : CTA and ACI Setup	
33-01 : ACI Port Type Setup	2-397
33-02 : ACI Department Calling Group	2-398
Program 34 : Tie Line Setup	
34-01 : E&M Tie Line Basic Setup	2-399
34-02 : E&M Tie Line Class of Service	2-401
34-03 : Trunk Group Routing for E&M Tie Lines	2-402
34-04 : E&M Tie Line Toll Restriction Class	2-403

34-05 : Tie Line Outgoing Call Restriction	2-404
34-06 : Add/Delete Digit for E&M Tie Line	2-405
34-07 : E&M Tie Line Timer	2-406
34-08 : Toll Restriction Data for E&M Tie Lines	2-407
34-09 : ANI/DNIS Service Options	2-408
34-10 : Digits Delete for T1 ANI Assignment	2-411
 Program 35 : SMDR Account Code Setup	
35-01 : SMDR Options	2-413
35-02 : SMDR Output Options	2-415
35-03 : SMDR Port Assignment for Trunk Group	2-418
35-04 : SMDR Port Assignment for Department Groups	2-419
35-05 : Account Code Setup	2-420
35-06 : Verified Account Code Table	2-422
 Program 40 : Voice Recording System	
40-01 : Voice Mail Basic Setup	2-423
40-02 : Mailbox Setup	2-424
40-03 : Message Recording Setup	2-425
40-04 : Live Recording Setup	2-426
40-05 : Call Information Setup	2-427
40-06 : Voice Mail Automated Attendant Data Setup	2-428
40-07 : Voice Prompt Language Assignment for VRS	2-429
40-08 : Voice Prompt Language Assignment for Mailboxes	2-431
40-09 : Voice Mail Multiple Address Group Setup	2-432
40-10 : Voice Announcement Service Option	2-433
40-11 : Preamble Message Assignment	2-435
 Program 41 : ACD Setup	
41-01 : System Options for ACD	2-437
41-02 : ACD Group and Agent Assignments	2-438
41-03 : Incoming Ring Group Assignment for ACD Group	2-439
41-04 : ACD Group Supervisor	2-441
41-05 : ACD Agent Work Schedules	2-442

41-06 : Trunk Work Schedules	2-443
41-07 : ACD Weekly Schedule Setup	2-444
41-08 : ACD Overflow Options	2-445
41-09 : ACD Overflow Table Setting	2-447
41-10 : ACI Delay Announcement	2-448
41-11 : VRS Delay Announcement	2-449
41-12 : Night Announcement Setup	2-451
41-13 : VRS Message Number for Night Announcement	2-452
41-14 : ACD Options Setup	2-453
41-15 : ACD Queue Alarm Information	2-456
41-16 : ACD Threshold Overflow	2-458
41-17 : ACD Login Mode Setup	2-459
41-18 : ACD Agent Identity Code Setup	2-460
41-19 : ACD Voice Mail Delay Announcement	2-462
41-20 : ACD Queue Display Settings	2-464
 Program 42 : Hotel Setup	
42-01 : System Options for Hotel/Motel	2-467
42-02 : Hotel/Motel Telephone Setup	2-468
42-03 : Class of Service Options (Hotel/Motel)	2-469
42-04 : Hotel Mode One-Digit Service Codes	2-471
42-05 : Hotel Room Status Printer	2-472
42-06 : PMS Service Setting	2-473
42-07 : PMS Restriction Level Conversion Table	2-474
 Program 44 : ARS/F-Route Setup	
44-01 : System Options for ARS/F-Route	2-475
44-02 : Dial Analysis Table for ARS/F-Route Access	2-476
44-03 : Dial Analysis Extension Table	2-478
44-04 : ARS/F-Route Selection for Time Schedule	2-480
44-05 : ARS/F-Route Table	2-481
44-06 : Additional Dial Table	2-483
44-07 : Gain Table for ARS/F-Route Access	2-484

44-08 : Time Schedule for ARS/F-Route	2-486
44-09 : Weekly Schedule for ARS/F-Route	2-488
44-10 : Holiday Schedule for ARS/F-Route	2-489

Program 45 : Voice Mail Integration

45-01 : Voice Mail Integration Options	2-491
45-02 : NSL Option Setup	2-494
45-04 : Voice Mail Digit Add Assignment	2-495
45-05 : Voice Mail Send Protocol Signal Without Additional Digits	2-496

Program 47 : In-Mail

47-01 : SV8100 InMail System Options	2-497
47-02 : SV8100 InMail Station Mailbox Options	2-505
47-03 : SV8100 InMail Group Mailbox Options	2-511
47-06 : Group Mailbox Subscriber Options	2-512
47-07 : SV8100 InMail Routing Mailbox Options	2-517
47-08 : Call Routing Mailbox Options	2-519
47-09 : Announcement Mailbox Options	2-521
47-10 : SV8100 InMail Trunk Options	2-523
47-11 : VM8000 InMail Answer Table Options	2-525
47-12 : VM8000 InMail Answer Schedules	2-529
47-13 : SV8100 InMail Dial Action Tables	2-538
47-15 : Routing Directory Mailbox Options	2-545
47-16 : InMail Language License	2-546
47-17 : Routing Distribution Mailbox Options	2-548
47-18 : VM8000 InMail SMTP Setup	2-549
47-19 : VM8000 InMail POP3 Setup	2-550

Program 50 : Common Channel Interoffice Signaling Service

50-01 : CCIS System Setting	2-551
50-02 : Connecting System Settings	2-552
50-03 : CCIS Destination System Settings	2-554
50-04 : CCIS Office Code Assignment	2-555

50-05 : CCIS Maximum Call Forwarding Hop Counter	2-556
50-06 : CCIS Feature Availability	2-557
50-07 : CCIS Centralized Billing Center Office	2-558
50-08 : CCIS Centralized BLF Sending Group Assignment	2-559
50-09 : CCIS Centralized BLF Sending Extension Number Assignment	2-560
50-10 : CCIS Centralized BLF Interval Time Assignment	2-562
50-11 : CCIS Centralized Day/Night Switching Sending Group Assignment	2-563
50-12 : CCIS Centralized Day/Night Mode to System Mode Assignment	2-564
50-13 : CCIS Centralized Response Timeout Assignment	2-565
50-14 : CCIS Intercom Digits for Caller ID Call Return	2-566
50-15 : CCIS over IP Basic Information Setting	2-567

Program 51 : NetLink Service

51-01 : NetLink System Property Setting	2-569
51-02 : NetLink System Individual Setting	2-571
51-03 : NetLink Internet Protocol Address List Setting	2-573
51-04 : IP Address Setting of Top Priority Primary System of NetLink	2-574
51-05 : NetLink Timer Settings	2-575
51-06 : NetLink Primary Automatic Integration Setting	2-577
51-07 : NetLink Primary Compulsion Specification Setting	2-578
51-08 : Primary NetLink Setting	2-579
51-09 : NetLink Communication Port Settings	2-580
51-10 : Virtual Slot Setting	2-582
51-11 : NetLink System Information	2-583
51-12 : Primary System Information	2-584
51-13 : NetLink Options	2-585
51-14 : NetLink System Control	2-586
51-15 : Demonstration Setting	2-587
51-16 : NetLink System Data Replication Mode Setting	2-588

Program 80 : Basic Hardware Setup for System

80-01 : Service Tone Setup	2-591
80-02 : DTMF Tone Setup	2-597
80-03 : DTMF Tone Receiver Setup	2-599
80-04 : Call Progress Tone Detector Setup	2-602
80-05 : Date Format for SMDR and System	2-604
80-07 : Call Progress Tone Detector Frequency Setup	2-605
80-09 : Short Ring Setup	2-606
80-10 : MF Tone Receiver Setup	2-609

Program 81 : Basic Hardware Setup for Trunk

81-01 : COT Initial Data Setup	2-611
81-02 : DIOPU Initial Data Setup	2-614
81-03 : ODT Initial Data Setup	2-616
81-04 : ISDN BRI Layer 1 (T-Point) Initial Data Setup	2-618
81-05 : ISDN BRI & PRI Layer 2 (T-Point) Initial Data Setup	2-619
81-06 : ISDN BRI & PRI Layer 3 (T-Point) Timer Setup	2-621
81-07 : CODEC Filter Setup for Analog Trunk Port	2-623
81-08 : T1 Trunk Timer Setup	2-624
81-09 : COT CODEC (QSLAC) Filter Setting	2-629
81-10 : COT Initial Data Setup	2-632
81-11 : Tie Line Initial Setup	2-634
81-12 : Trunk Pad Level Data Setup	2-637
81-14 : DIOPU (LD Trunk) CODEC (QSLAC) Filter Data Setup	2-638
81-15 : TLIU(2W) CODEC (QSLAC) Filter Data Setup	2-641
81-16 : TLIU(4W) CODEC (QSLAC) Filter Data Setup	2-644
81-17 : CODEC Filter Option Data Type Setup	2-647

Program 82 : Basic Hardware Setup for Extension

82-01 : Incoming Ring Tone	2-649
82-03 : DSS Console LED Pattern Setup	2-651
82-04 : LCA Initial Data Setup	2-653
82-07 : CODEC Filter Setup for Analog Station Port	2-655

82-08 : Sidetone Volume Setup	2-656
82-09 : LCA CODEC Filter Data Setup	2-657
82-11 : LCA Initial Data Setup	2-660
82-12 : OPX Initial Data Setup	2-661
82-14 : Handset/Headset Gain for Multiline Telephone	2-662
82-15 : OPX CODEC (QSLAC) Filter Data Setup	2-663
82-16 : SLI CODEC (QSLAC) Filter Data Setup	2-666
82-17 : CODEC Filter Option Data Type Setup	2-669

Program 84 : Hardware Setup for VoIP

84-01 : H.323 Trunk Basic Information Setup	2-671
84-02 : H.225 and H.245 Information Basic Setup	2-676
84-03 : IP Phone Information Basic Setup	2-678
84-06 : PVA Data Setting	2-680
84-07 : Firmware Download Setup	2-682
84-08 : Firmware Name Setup	2-683
84-09 : VLAN Setup	2-684
84-10 : ToS Setup	2-685
84-11 : <i>D^{term}</i> ® IP CODEC Information Basic Setup	2-687
84-13 : SIP Trunk CODEC Information Basic Setup	2-690
84-14 : SIP Trunk Basic Information Setup	2-694
84-15 : H.323/SIP Phone Keep Alive Setup	2-696
84-16 : VoIP Limiter Control Gain Setup	2-697
84-19 : SIP Extension CODEC Information Basic Setup	2-698
84-20 : SIP Extension Basic Information Setup	2-702
84-21 : CCIS over IP CODEC Information Basic Setup	2-703
84-22 : DT700 Multiline Logon Information Setup	2-707
84-23 : DT700 Multiline Basic Information Setup	2-709
84-24 : DT700 Multiline CODEC Basic Information Setup	2-711
84-25 : NetLink CODEC Information Basic Setup	2-714
84-26 : IPL Basic Setup	2-718
84-27 : IPL Basic Setup	2-720
84-28 : DT700 Multiline Firmware Name Setup	2-722

84-29 : SIP-MLT CODEC Information Fixed Mode Setup	2-723
84-30 : PVA-CCIS over IP CODEC Setup	2-724
Program 85 : HUB(8) LAN Setup	
85-01 : HUB(8) LAN Setup	3-727
85-02 : HUB(8) VLAN Setup	3-729
85-03 : Priority Setup	3-731
85-04 : Port Mirroring Setup	3-733
85-05 : HUB(8) VLAN Group Settings	3-734
Program 90 : Maintenance Program	
90-01 : Installation Date	2-737
90-02 : Programming Password Setup	2-738
90-03 : Save Data	2-740
90-04 : Load Data	2-741
90-05 : Slot Control	2-742
90-06 : Trunk Control	2-743
90-07 : Station Control	2-744
90-08 : System Reset	2-745
90-09 : Automatic System Reset Time Setup	2-746
90-10 : System Alarm Setup	2-747
90-11 : System Alarm Report	2-756
90-12 : System Alarm Output	2-758
90-13 : System Information Output	2-759
90-16 : Main Software Information	2-760
90-17 : Firmware Information	2-761
90-19 : Dial Block Release	2-762
90-20 : Traffic Report Data Setup	2-763
90-21 : Traffic Report Output	2-765
90-22 : Terminal Version information	2-766
90-23 : Deleting Registration of IP Telephones	2-767
90-24 : System Alarm Report Notification Time Setup	2-768
90-25 : System Alarm Report CC Mail Setup	2-769

90-26 : Program Access Level Setup	2-770
90-28 : User Programming Password Setup	2-771
90-31 : DIM Access over Ethernet	2-772
90-34 : Firmware Information	2-773
90-35 : Wizard Programming Level Setup	2-774
90-36 : Firmware Update Time Setting	2-775
90-38 : User Programming Data Level Setup	2-777
90-39 : Virtual Loop Back Port Reset	2-780
90-41 : Server Setting to Update Terminal Local Data	2-781
90-42 : DT700 Multiline Terminal Version Information	2-782
90-43 : Deleting Terminal License of DT700	2-783
90-44 : Deleting Terminal License of TCP Interface	2-784
90-45 : Temporary Password Change for Multiline Telephone	2-785
90-48 : Button Kit Information of Multiline Telephone	2-786
90-49 : Protection Mode Setup for Multiline Telephone	2-787
90-50 : System Alarm Display Setup	2-788
90-51 : Alarm Setup for Maintenance Exchange	2-789
90-52 : System Alarm Save	2-791
90-53 : System Alarm Clear	2-792
90-54 : PC/Web Programming	2-793
90-55 : Free License Select	2-794
90-56 : NTP Setup	2-795
90-57 : Backup Recovery Data	2-796
90-58 : Restore Recovery Data	2-797
90-59 : Delete Recovery Data	2-798
90-60 : T1/ISDN Layer Status Information	2-799
90-61 : Manual Slot Install	2-800
90-62 : Security ID Information	2-801
90-63 : DT700 Control	2-802
90-64 : SNMP Setup	2-803
90-65 : 1st Party CTI Authentication Password Setup	2-804

Program 92 : Copy Program

92-01 : Copy Program 2-805
92-02 : Delete All Extension Numbers 2-809
92-03 : Copy Program by Port Number 2-810
92-04 : Extension Data Swap 2-811
92-05 : Extension Data Swap Password 2-814
92-06 : Fill Command 2-815
92-07 : Delete Command 2-817

LIST OF TABLES

Table 1-1	Keys for Entering Data	1-4
Table 1-2	Keys for Entering Names	1-5
Table 1-3	Softkey Display Prompts	1-7
Table 1-4	System Number Plan/Capacities	1-8
Table 2-1	Programming Modes	2-1
Table 2-2	License Information	2-66
Table 2-3	System Numbering Default Settings	2-79
Table 2-4	Lamp Cycle On/Off Timing Pattern	2-166
Table 2-5	Program 15-02 – Incoming Signal Frequency Patterns	2-166
Table 2-6	Program 15-08 – Incoming Signal Frequency Patterns	2-186
Table 2-7	Ringling Cycles	2-238
Table 2-8	Program 22-03 – Incoming Signal Frequency Patterns	2-297
Table 2-9	LED Patterns for DSS Console	2-378
Table 2-10	47-02-16 Default Table	2-509
Table 2-11	47-06-14 Default Table	2-516
Table 2-12	47-07-03 Default Table	2-518
Table 2-13	47-10-03 Default Table	2-524
Table 2-14	47-16-01 Default Table	2-547
Table 2-15	Basic Tones	2-592
Table 2-16	Frequency 1/2 Table	2-606
Table 2-17	Ring Cycle Table	2-607
Table 2-18	Default Table	2-608
Table 2-19	Default Table	2-610
Table 2-20	Description of Alarm	2-747

THIS PAGE INTENTIONALLY LEFT BLANK

Introduction



SECTION 1 BEFORE YOU START PROGRAMMING



Before customizing your system be sure to read this chapter first.

This chapter provides you with detailed information about the system programs. By changing a program, you change the way the feature associated with that program works. In this chapter, you find out about each program, the features that the program affects and how to enter the program data into system memory.

SECTION 2 HOW TO USE THIS MANUAL

This section lists each program in numerical order. For example, Program 10-01 is at the beginning of the section and Program 92-01 is at the end. The information on each program is subdivided into the following headings:

Description describes what the program options control. The Default Settings for each program are also included. When you first install the system, it uses the Default Setting for all programs. Along with the Description are the **Conditions** which describe any limits or special considerations that may apply to the program.

The reverse type (white on black) just beneath the Description heading is the program access level. You can only use the program if your access level meets or exceeds the level the program requires. Refer to [Section 3 How to Enter Programming Mode on page 1-2](#) for a list of the system access levels and passwords.

Feature Cross Reference provides you with a table of all the features affected by the program. You will want to keep the referenced features in mind when you change a program. Customizing a feature may have an effect on another feature that you did not intend.

Telephone Programming Instructions shows how to enter the program data into system memory. For example:

1. Enter the programming mode.
2. 15-07-01



The screenshot shows a black background with white text. The first line reads "15-07-01 TEL". The second line reads "KY01 = *01". Below the text are two white arrows, one pointing left and one pointing right.

tells you to enter the programming mode, dial 150701 from the telephone dial pad. After you do, you will see the message “15-07-01 TEL” on the first line of the telephone display. This indicates the program number (15-07), item number (01), and that the options are being set for the extension . The second row of the display “KY01 = *01” indicates that Key 01 is being programmed with the entry of *01. The third row allows you to move the cursor to the left or right, depending on which arrow is pressed. To learn how to enter the programming mode, refer to [Section 3 How to Enter Programming Mode](#) below.

SECTION 3 HOW TO ENTER PROGRAMMING MODE

To enter programming mode:

1. Go to any working display telephone.
 *In a newly installed system, use extension (port 1).*
2. *Do not* lift the handset.
3. Press **Speaker**.
4. **# * # * .**



The screenshot shows a black background with white text. The word "Password" is displayed in a white box.

5. Dial the system password + **Transfer**.
Refer to the following table for the default system passwords. To change the passwords, use [90-02 : Programming Password Setup](#).

Password	User Name	Level	Programs at this Level
47544	necii	1 (MF)	Manufacturer (MF): All programs
12345678	tech	2 (IN)	Installation (IN): All programs in this section not listed below for SA and SB
0000	ADMIN1	3 (SA)	System Administrator – Level 1 (SA): 10-01, 10-02, 10-12, 10-13, 10-14, 10-15, 10-16, 10-17, 10-18, 10-22, 12-02, 12-03, 12-04, 15-01, 15-07, 15-09, 15-10, 15-11, 20-16, 21-07, 21-14, 22-04, 22-11, 25-08, 30-03, 32-02, 40-02, 41-02, 41-03, 41-04, 41-05, 41-06, 41-07, 41-08, 41-09, 41-10, 41-11, 41-12, 41-13, 41-14, 41-15, 41-16, 41-17, 41-18, 90-03, 90-04, 90-06, 90-07, 90-18, 90-19
9999	ADMIN2	4 (SB)	System Administrator – Level 2 (SB): 13-04, 13-05, 13-06

SECTION 4 HOW TO EXIT PROGRAMMING MODE

To exit the programming mode:

When you are done programming, you must be out of a program option to exit (pressing the **Answer** key will exit the program option).

1. Press **Answer** key to exit the program options, if needed.

Program Mode
Base Service OP1 OP2

2. Press **Speaker**. If changes were to the system programming, "Saving System Data" is displayed.
3. The display shows "Complete Data Save" when completed and exits the telephone to an idle mode.

 *To save a customer's database, a blank USB Drive is required. Insert the USB Drive into the CD-CP00-US and, using Program 90-03, save the software to the USB Drive. (Program 90-04 is used to reload the customer data if necessary.) Note that a USB Drive can only hold one customer database. Each database to be saved requires a separate drive.*

SECTION 5 USING KEYS TO MOVE AROUND IN THE PROGRAMS

Once you enter the programming mode, use the keys in the following chart to enter data, edit data and move around in the menus.

Table 1-1 Keys for Entering Data

Keys for Entering Data	
Use this key...	When you want to...
0~9 and *	Enter data into a program.
Transfer	Complete the programming step you just made (e.g., pressing Enter on a PC keyboard). When a program entry displays, press Transfer to bypass the entry without changing it.
Recall	Delete the entry to the left (e.g., pressing Backspace on a PC keyboard).
Hold	Delete or clear all characters to the right of the cursor.
Answer	Exit one step at a time from the program window currently being viewed. For example, if programming item 5 in 15-03, pressing Answer allows you to enter a new option in program 15-03. Pressing Answer again allows you to select a new program in the 15-XX series. Pressing Answer a third time allows you to enter a new program beginning with 1 . Pressing Answer one last time brings you to the beginning program display, allowing you to enter any program number.
MIC	Switch between the different input data fields by pressing MIC . The cursor moves up to the top row of the display. Pressing MIC again moves the cursor back to the middle row.
LINE KEYS	Use pre-programmed settings to help with the program entry. These settings vary between programs from LINE 1 = 0 (off) and LINE 2 = 1 (on) to preset values for timers where LINE 1 = 5, LINE 2 = 10, LINE 3 = 15, etc. For programs with this option, the line key, which currently matches the programmed setting, lights steady. The display can also indicate Softkey, which will allow you to select the values as well (-1 and +1 will step through these pre-programmed settings.)
LINE KEY 1	Program a pause into a Speed Dialing bin.
LINE KEY 2	Program a recall/flash into a Speed Dialing bin.
LINE KEY 3	Program an @ into a Speed Dialing bin.

Table 1-1 Keys for Entering Data (Continued)

Keys for Entering Data	
Use this key...	When you want to...
VOL ▲	Scroll backward through a list of entry numbers (e.g., from extension etc.) or through entries in a table (e.g., Common Permit Table). If you enter data and then press this key, the system accepts the data before scrolling forward.
VOL ▼	Scroll forward through a list of entry numbers (e.g., from extension etc.) or through entries in a table (e.g., Common Permit Table). If you enter data and then press this key, the system accepts the data before scrolling backward.

SECTION 6 PROGRAMMING NAMES AND TEXT MESSAGES

Several programs (e.g., Program 20-16 : Selectable Display Messages) require you to enter text. Use the following chart when entering and editing text. When using the keypad digits, press the key once for the first character, twice for the second character, etc. For example, to enter a C, press the key **2** three times. Press the key six times to display the lower case letter. The name can be up to 12 digits long.

Table 1-2 Keys for Entering Names

Use this keypad digit . . .	When you want to . . .
1	Enter characters: 1 @ [¥] ^ _ ` { } Æ " Á À Â Ã Ç É Ê Ì Ó
2	Enter characters: A-C, a-c, 2.
3	Enter characters: D-F, d-f, 3.
4	Enter characters: G-I, g-i, 4.
5	Enter characters: J-L, j-l, 5.
6	Enter characters: M-O, m-o, 6.
7	Enter characters: P-S, p-s, 7.
8	Enter characters: T-V, t-v, 8.
9	Enter characters: W-Z, w-z, 9.
0	Enter characters: 0 ! “ # \$ % & ’ () ô Õ ú ä ö ü α ε θ

Table 1-2 Keys for Entering Names

Use this keypad digit . . .	When you want to . . .
*	Enter characters: * + , - . / : ; < = > ? π Σ σ Ω □ ϕ £
#	# = Accepts an entry (only required if two letters on the same key are needed – ex: TOM). Pressing # again = Space. (In system programming mode, use the right arrow Softkey instead to accept and/or add a space.)
Conf	Clear the character entry one character at a time.
Hold	Clear all the entries from the point of the flashing cursor and to the right.

SECTION 7 USING SOFTKEYS FOR PROGRAMMING

Each UNIVERGE SV8100 display telephone provides interactive Softkeys for intuitive feature access. The options for these keys will automatically change depending on where you are in the system programming. Simply press the Softkey located below the option you wish and the display will change accordingly.

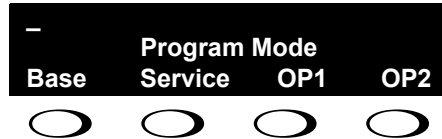

Pressing the VOLUME ▲ or VOLUME ▼ will scroll between the menus.

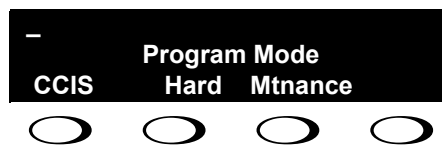

SECTION 8 WHAT THE SOFTKEY DISPLAY PROMPTS MEAN

When using a display telephone in programming mode, various Softkey options are displayed. These keys will allow you to easily select, scan, or move through the programs.

Table 1-3 Softkey Display Prompts

Softkey Display Prompts	
If you press this Softkey . . .	The system will. . .
back	Go back one step in the program display. You can press VOLUME ▲ or VOLUME ▼ to scroll forward or backward through a list of programs.
↑	Scroll down through the available programs.
↓	Scroll up through the available programs.
select	Select the currently displayed program.
←	Move the cursor to the left.
→	Move the cursor to the right.
-1	Move back through the available program options.
+1	Move forward through the available program options.

SECTION 9 SYSTEM NUMBER PLAN/CAPACITIES

The following table provides the capacities for the UNIVERGE SV8100 system.

Table 1-4 System Number Plan/Capacities

System Number Plan/Capacities	
System Type	Number Plan/Capacities
System	
Analog Caller ID Detector (detected by DSP)	32/64 channels
Classes of Service	15
Day/Night Mode Numbers	8
Day/Night Service Patterns	32
Dial Tone Detector DTMF Receiver	64
Toll Restriction Classes	15
Verifiable Account Code Table	2000
Trunk	
Trunk Port Number	200
Trunk Ports (Total):	200
o Analog Trunks	176
o BRI Trunk Ports	176
o T1/PRI Trunk Ports	200
o E&M Analog Trunk Ports	44
o DID Analog Trunk Ports	88
o VoIP Trunk Ports	200
DID Translation Tables	20
DID Translation Table Entries	2000
DISA:	
o Classes of Service	15
o Users	15
Ring Groups	100
Tie Line Classes of Service	15
Tie Line Toll Restriction Classes	15
Trunk Access Maps	200
Trunk Group Numbers	100
Trunk Routes	100

Table 1-4 System Number Plan/Capacities (Continued)

System Number Plan/Capacities	
System Type	Number Plan/Capacities
Extension	
Telephone Extension Ports	512
○ Multiline Terminals	256
○ Single Line Phones/Analog Devices	256
○ VoIP Extensions	512
○ SIP DECT Wireless	504
DLCA:	
○ Physical Ports	01~16
LCA:	
○ Physical Ports	01~16
Telephone Extension Number Range	1~89999999* (*Extension cannot start with 0 or 9)
Virtual Extension Ports	256
Virtual Extension Number Range	1~89999999* (*Extension cannot start with 0 or 9)
PGD(2)-U10 ADP	56
ADA (Recording Jack) Adapters	240
UNIVERGE SV8100 Wireless – SIP DECT Access Points	Unlimited
Door Boxes	8
Door Box Numbers	1~8
DSS Consoles Numbers:	
○ 60 Button DSS Console	32
Operator Access Number	0 (Default)
Operator Extension	15
Ringdown Assignments	512
SLT Adapters	16
HF-R Adapters	240

Table 1-4 System Number Plan/Capacities (Continued)

System Number Plan/Capacities	
System Type	Number Plan/Capacities
Speed Dialing	
Speed Dialing Groups	64
Speed Dialing Bins	0~1999
Speed Dialing Table-Common	1000
ACD	
ACD Groups	64
ACD Agent Extensions	512
ACI	
ACI Groups	16
ACI Ports	96
Automated Attendant	
VRS Message Numbers	1~100
Conference	
Conference Circuits	64 - maximum (32 Parties Per Conference)
Data Communication Interfaces	
APR Software Port Numbers	449~512
APA Adapters	240
APR Adapters	240
CTA or CTU Adapters	32 (Only works with DTH/DTR style telephones)
Department and Pickup Groups	
Department (Extension) Group Numbers	1~64
Call Pickup Group Numbers	1~64
Hotline	
Internal Hotline	512
External Hotline	512

Table 1-4 System Number Plan/Capacities (Continued)

System Number Plan/Capacities	
System Type	Number Plan/Capacities
Paging and Park	
Internal Page Group Numbers	0, 01~64
External Page Group Numbers	0, 1~8
External Speakers <ul style="list-style-type: none"> ○ CD-CP00-US()-U10 ○ PGD(2)-U10 ADP 	9 (1) (1~8)
Park Group Numbers	1~64
Park Orbits	1~64
SMDR	
SMDR Ports	1~8
VRS/VM8000 InMail	
VRS/VM8000 InMail	1
VRS/VM8000 InMail Channels	16 (Note 1)
VRS Attendant Messages	3
VRS Recordable Messages	100
VM8000 InMail Ports	8 (Note 1)
VoIP	
ADA2 (Recording Jack) Adapters	240
PSA (Power Failure) Adapters	256
RTP Ports	0~65535
RTCP Ports	0~65535
DSP Resources	128 (Note 2)
Passwords	
Programming Passwords:	
Level 1 (MF) PCPro/WebPro User Name:	47544 necii
Level 2 (IN) PCPro/WebPro User Name:	12345678 tech

Note 1: The PZ-VM21 supports up to 16 ports and they are shared by the VM8000 InMail and VRS.

Note 2: The maximum number of VOIP DSP Resources depend on which PZ-IPLA is installed.

Table 1-4 System Number Plan/Capacities (Continued)

System Number Plan/Capacities	
System Type	Number Plan/Capacities
Level 3 (SA) PCPro/WebPro User Name:	0000 ADMIN1
Level 4 (SB) PCPro/WebPro User Name:	9999 ADMIN2
Programming Password Users	8
Extension numbers can be one to eight digits long. Refer to the Flexible System Numbering feature in the UNIVERGE SV8100 Features and Specifications Manual.	

Programming the UNIVERGE SV8100



SECTION 1 PROGRAMMING YOUR SYSTEM

The information contained in this chapter provides the information necessary to properly program your UNIVERGE UNIVERGE SV8100 system.

The programming blocks are organized into the following programming modes.

Table 2-1 Programming Modes

Program Number : Program Name
Program 10 : System Configuration Setup
Program 11 : System Numbering
Program 12 : Night Mode Setup
Program 13 : Abbreviated Dialing
Program 14 : Trunk, Basic Setup
Program 15 : Extension, Basic Setup
Program 16 : Department Group Setup
Program 20 : System Option Setup
Program 21 : Outgoing Call Setup
Program 22 : Incoming Call Setup
Program 23 : Answer Features Setup
Program 24 : Hold/Transfer Setup
Program 25 : VRS/DISA Setup
Program 26 : ARS Service
Program 30 : DSS/DLS Console Setup

Table 2-1 Programming Modes (Continued)

Program Number : Program Name
Program 31 : Paging Setup
Program 32 : Door Box and Sensor Setup
Program 33 : CTA and ACI Setup
Program 34 : Tie Line Setup
Program 35 : SMDR Account Code Setup
Program 40 : Voice Recording System
Program 41 : ACD Setup
Program 42 : Hotel Setup
Program 44 : ARS/F-Route Setup
Program 45 : Voice Mail Integration
Program 47 : In-Mail
Program 50 : Common Channel Interoffice Signaling Service (CCIS)
Program 51 : NetLink Service
Program 80 : Basic Hardware Setup for System
Program 81 : Basic Hardware Setup for Trunk
Program 82 : Basic Hardware Setup for Extension
Program 84 : Hardware Setup for VoIP
Program 85 : HUB(8) LAN Setup
Program 90 : Maintenance Program
Program 92 : Copy Program

Program 10 : System Configuration Setup

10-01 : Time and Date

Level:
SA

Program

10

Description

Use **Program 10-01 : Time and Date** to change the system Time and Date through system programming. Extension users can also dial Service Code 728 to change the time if allowed by an extension Class of Service.

Input Data

Item No.	Item	Input Data	Default	Description
01	Year	00~99	No Setting	Enter 2 digits for year (00~99).
02	Month	01~12	No Setting	Enter 2 digits (01~12) for the month.
03	Day	01~31	No Setting	Enter 2 digits (01~31) for the day.
04	Week	1~7 (Sun~Sat)	No Setting	Enter digit for the day of the week (1=Sunday, 7=Saturday).
05	Hour	00~23	No Setting	Enter 2 digits for the hour (00~23).
06	Minute	00~59	No Setting	Enter 2 digits for the minute (00~59).
07	Second	00~59	No Setting	Enter 2 digits for the second (00~59).

Conditions

None

Feature Cross Reference

Clock/Calendar Display

Program 10 : System Configuration Setup

10-02 : Location Setup

Level:

SA

Description

Use **Program 10-02 : Location Setup** to define the location of the installed system.

Input Data

Item No.	Item	Input Data	Default	Description
01	Country Code	Dial (up to four digits): 0~9, *, #	1	Enter the country code.
02	International Access Code	Dial (up to four digits): 0~9, *, #	No setting	Enter the international access code.
03	Other Area Access Code	Dial (up to two digits): 0~9, *, #	9	Enter the other area access code
04	Area Code	Dial (up to six digits): 0~9, *, #	No setting	Enter the local area code.
05	Trunk Access Code	Dial (up to eight digits): 0~9, *, #	No setting	Enter the trunk access code digits required to place an outgoing call.

Conditions

None

Feature Cross Reference

None

Program 10 : System Configuration Setup

10-03 : ETU Setup

Level:
IN

Description

Use **Program 10-03 : ETU Setup** to setup and confirm the Basic Configuration data for each blade. When changing a defined terminal type, first set the type to 0 and then plug the new device in to have the system automatically define it or you may have to reset the blade.

 The items highlighted in *gray* are read only and cannot be changed.

Input Data

For CNF PKG Setup

Physical Port Number	01~16
----------------------	-------

Item No.	Item	Input Data	Default
01	Logical Port Number	0~256	0

For DLCA PKG Setup

Physical Port Number	01~16
----------------------	-------

Item No.	Item	Input Data	Default
01	Terminal Type (B1)	0 = Not set 1 = Multiline Terminal 2 = SLT Adapter 3 = Bluetooth Cordless Handset 6 = PGD(2)-U10 ADP (Paging) 7 = PGD(2)-U10 ADP (Tone Ringer) 8 = PGD(2)-U10 ADP (Door Box) 9 = PGD(2)-U10 ADP (ACI) 10 = DSS Console 11 = --- Not Used ---	0

Item No.	Item	Input Data	Default
02	Logical Port Number (B1)	0 = Not set 1 = Multiline Terminal (1~512) 2 = SLT Adapter (1~512) 6 = PGD(2)-U10 ADP (Paging) (1~8) 7 = PGD(2)-U10 ADP (for Tone Ringer) (1~8) 8 = PGD(2)-U10 ADP (for Door Box) (1~8) 9 = PGD(2)-U10 ADP (for ACI) (1~96) 10 = DSS (1~32) 11 = --- Not Used ---	0
03	--- Not Used ---		
04	Optional Installed Unit 1 (Only applies to DTH/DTR-style telephones)	0 = None 1 = APR Module 2 = APA Module 3 = ADA Module 4 = CTA/CTU Module	0
05	Optional Installed Unit 2	0 = None 1 = APR Module 2 = APA Module 3 = ADA Module 4 = CTA/CTU Module	0

B-Channel 2			
Item No.	Item	Input Data	Default
06	Terminal Type (B2)	0 = Not set 6 = PGD(2)-U10 ADP (Paging) 7 = PGD(2)-U10 ADP (Tone Ringer) 8 = PGD(2)-U10 ADP (Door Box) 9 = PGD(2)-U10 ADP (ACI) 12 = APR (B2 Mode)	0
07	Logical Port Number (B2)	0 = Not set 6 = PGD(2)-U10 ADP (Ext. Speaker) 7 = PGD(2)-U10 ADP (Paging/Tone Ringer) = (1~8) 8 = PGD(2)-U10 ADP (for Door Box) = (1~8) 9 = PGD(2)-U10 ADP (ACI) = (1~96) 12 = APR (for B2 mode) (193~512)	0
08	Multiline Telephone Type	0 = DT3** 1 = $D^{term} 8$ 2 = $D^{term} 7$	0

09	Side Option Information	0 = No option 1 = 8LK Unit 2 = 16LK Unit 3 = 24ADM	0
10	Bottom Option Information (Only applies to DTL-style telephones)	0 = No option 1 = APR 2 = ADA 3 = BHA	0
11	Handset Option Information	0 = No option 1 = PSA/PSD 2 = Bluetooth Cordless Handset	0

For LCA PKG Setup

Physical Port Number	01~16
----------------------	-------

Item No.	Item	Input Data	Default
01	Logical Port Number	0~512	0
03	Transmit Gain Level (S-Level)	1~63 (-15.5 +15.5dB)	32 (0dB)
04	Receive Gain Level (R-Level)	1~63 (-15.5 +15.5dB)	32 (0dB)

For COTA Unit Setup

Physical Port Number	1~8
----------------------	-----

Item No.	Item	Input Data	Default
01	Logical Port Number	0~200	0

For CD-PVAA Unit Setup

Physical Port Number	01~16
----------------------	-------

Item No.	Item	Input Data	Default
01	Logical Port Number	0~200	0

For ODTA PKG Setup

Physical Port Number	01~04
----------------------	-------

Item No.	Item	Input Data	Default
01	Logical Port Number	0~200	0
02	2/4 Wire	0 = 2 Wire 1 = 4 Wire	1
03	E&M Line Control Method	0 = TYPE I 1 = TYPE V	0

For DIOP PKG Setup

Physical Port Number	01~04
----------------------	-------



Item No.	Item	Input Data	Default
01	LD/OPX Specification	0 = LD Trunk 1 = OPX	0
02	Logical Port Number	0 = 1~200 (LD Trunk) 1 = 1~256 (OPX)	0

For BRIA PKG Setup

Item No	Item	Input Data	Default
	ISDN Line Number	01~04	
01	ISDN Line Mode	0 = Not Used 1 = T-Point	1
02	Logical Port Number <i>The starting port number of a BRI line is displayed. Two logic ports are automatically assigned to a BRI line.</i>	0 = Not Used 1 = For T-Bus (1~200)	0
03	Connection Type	0 = Point-to-Multipoint 1 = Point-to-Point	0
04	Layer 3 Timer Type <i>Each timer value of Layer 3 is set up for every type using Program 81-06 (T-Bus).</i>	1~5	1
05	CLIP Information Announcement Based on this setting, the system includes a Presentation Allowed (1) or Presentation Restricted (0) in the Setup message to allow or deny the Calling Party Number. Program 15-01-04 must also be set to 1 if this option is enabled.	0 = Disable 1 = Enable	1
06	--- Not Used ---		
07	--- Not Used ---		
08	Dial Sending Mode ISDN Protocol definition	0 = Enblock Sending 1 = Overlap Sending	1
09	Dial Information Element ISDN Protocol definition [Only when Dialing Sending Mode (10-03-08) is set for 1 (Overlap Sending)]	0 = Keypad Facility 1 = Called Party Number	0
10	Master/Slave System If set to 0, system is synchronized to the network clock. If set to 1, system is not synchronized to the network clock.	0 = Slave System 1 = Master System	0
11	--- Not Used ---		
14	--- Not Used ---		
15	--- Not Used ---		
17	ISDN Line Ringback Tone If Telco does not provide ringback tone, SV8100 can if set to 1:Enable.	0 = Disable 1 = Enable	0

Item No	Item	Input Data	Default
18	Type of Number ISDN Protocol definition	0 = Unknown 1 = International number 2 = National number 3 = Network specific number 4 = Subscriber number 5 = Abbreviated number	2
19	Numbering Plan Identification ISDN Protocol definition	0 = Unknown 1 = ISDN numbering plan 2 = Data numbering plan 3 = Telex numbering plan 4 = National standard numbering plan 5 = Private numbering plan	1
22	--- Not Used ---		
23	Straight/Cross Wiring	0 = Auto 1 = Manual (Cross) 2 = Manual (Straight)	0
24	--- Not Used ---		

For PRTA PKG Setup

Item No.	Item	Input Data	Default
01	--- Not Used ---		
02	Logical Port Number  The start port number of a PRI line is displayed.	1 = for T-Bus 1~200	1
03	--- Not Used ---		
04	Layer 3 Timer Type  Each timer value of Layer 3 is set up for each type in Program 81-06 (T-Bus)	1~5	1
05	CLIP Information Based on this setting, the system includes a Presentation Allowed (1) or Presentation Restricted (0) in the Setup message to allow or deny the Calling Party Number. Program 15-01-04 must also be set to 1 if this option is enabled.	0 = Disable 1 = Enable	1
06	Length of Cable	0 = Level 1 1 = Level 2 2 = Level 3 3 = Level 4 4 = Level 5	2
07	--- Not Used ---		
08	Dial Sending Mode ISDN Protocol definition	0 = Enbloc Sending 1 = Overlap Sending	0
09	Dial Information Element ISDN Protocol definition (Only when Dialing Sending Mode (10-03-08) is set for 1 (Overlap Sending)	0 = Keypad Facility 1 = Called Party Number	0
10	--- Not Used ---		
11	--- Not Used ---		
12	--- Not Used ---		

Item No.	Item	Input Data	Default
13	Loss-Of-Signal Detection Limit If the transmit/receive voltage is less than the setting in 10-03-13, the system considers this as Loss-Of-Signal and the PRTA does not come up.	0 = Level 0 (lowest sensitivity) 1 = Level 1 2 = Level 2 3 = Level 3 4 = Level 4 5 = Level 5 6 = Level 6 7 = Level 7 (highest sensitivity)	2
14	--- Not Used ---		
15	--- Not Used ---		
16	--- Not Used ---		
17	ISDN Ringback Tone If Telco does not provide ringback tone, SV8100 can if 10-03-17 is set to 1:Enable.	0 = Disable 1 = Enable	1
18	Type of Number ISDN Protocol definition. Select the number type for the ISDN circuit.	0 = Unknown 1 = International number 2 = National number 3 = Network Specific number 4 = Subscriber number 5 = Abbreviated number	2
19	Numbering Plan Identification ISDN Protocol definition. Select the Numbering Plan used for the ISDN circuit.	0 = Unknown 1 = ISDN numbering plan 2 = Data numbering plan 3 = Telex numbering plan 4 = National standard numbering plan 5 = Private numbering plan	1
20	Network Exchange Selection Select the ISDN protocol for the ISDN circuit.	0 = Standard (same as NI-2) 1 = reserved 2 = reserved 3 = DMS (A211) 4 = 5ESS 5 = DMS (A233) 6 = 4ESS 7 = NI-2	0
21	Number of Ports	0 = Auto 1 = 4 Ports 2 = 8 Ports 3 = 12 Ports 4 = 16 Ports 5 = 20 Ports	0
22	--- Not Used ---		

Item No.	Item	Input Data	Default
23	Straight/Cross Wiring	0 = Auto 1 = Manual (Cross) 2 = Manual (Straight)	0

For DTI (T1) PKG Setup

Physical Port Number	01~24
----------------------	-------

Item No.	Item	Input Data	Default
01	Logical Port Number The start port number of a T1 line is displayed, and 24 logic ports are automatically assigned to a DTI (T1) line.	0~200	0
02	T1 Signal Format Selection	0 = D4 (12 Multi Frame) 1 = ESF (24 Multi Frame)	1
03	Zero Code Suppression	0 = B8ZS 1 = AMI/ZCS	0
04	Line Length Selection	0 = 0 feet ~ 133 feet 1 = 133 feet ~ 266 feet 2 = 266 feet ~ 399 feet 3 = 399 feet ~ 533 feet 4 = 533 feet ~ 655 feet	0
05	T1 Clock Source	0 = Internal 1 = External	1
06	Number of Ports	0 = Auto 1 = 4 Ports 2 = 8 Ports 3 = 12 Ports 4 = 16 Ports 5 = 20 Ports	0
07	Straight/Cross Wiring	0 = Auto 1 = Manual (Cross) 2 = Manual (Straight)	0

For IPLA PKG Setup

Physical Port Number	001~200
----------------------	---------

Item No.	Item	Input Data	Default
01	Trunk Logical Port Number	0~200	0
02	Trunk Type	0 = H.323 1 = SIP	1
03	CCIS Trunk	0 = Not CCIS 1 = CCIS	0

For VM00 PKG Setup

Physical Port Number	01~16
----------------------	-------

Item No.	Item	Input Data	Default
01	Logical Port Number	0~256	0

For CCTA PKG Setup

Physical Port Number	01~24
----------------------	-------

Item No.	Item	Input Data	Default
01	Logical Port Number The start port number of a T1 line is displayed, and 24 logic ports are automatically assigned to a DTI (T1) line.	0~200	0
02	T1 Signal Format Selection	0 = D4 (12 Multi Frame) 1 = ESF (24 Multi Frame)	1
03	Zero Code Suppression	0 = B8ZS 1 = AMI/ZCS	0
04	Line Length Selection	0 = 0 feet ~ 133 feet 1 = 133 feet ~ 266 feet 2 = 266 feet ~ 399 feet 3 = 399 feet ~ 533 feet 4 = 533 feet ~ 655 feet	0
05	T1 Clock Source	0 = Internal 1 = External	1

06	Number of Ports	0 = Auto 1 = 4 Ports 2 = 8 Ports 3 = 12 Ports 4 = 16 Ports 5 = 20 Ports	0
07	Straight/Cross Wiring	0 = Auto 1 = Manual (Cross) 2 = Manual (Straight)	0

Conditions

- When changing a defined terminal type, first set the type to 0 and then plug the new device in to have the system automatically define it, or redefine the type manually.
- The system must have a blade installed to view/change the options for that type of blade.

Feature Cross Reference

- Universal Slots

Program 10 : System Configuration Setup

10-04 : Music On Hold Setup

Level:

IN

Description

Use **Program 10-04 : Music on Hold Setup** to set the Music on Hold (MOH) source. For internal Music on Hold, the system can provide a service tone callers on hold or one of eleven synthesized selections.

Input Data

Item No.	Item	Input Data	Default	Description
01	Music on Hold Source Selection	0 = Internal MOH 1 = External MOH 2 = Service Tone 3 = VMDB	2	The Music on Hold (MOH) source can be internal (synthesized) or from a customer-provided music source. The customer-provided source can connect to a PGD(2)-U10 ADP or the connector on the side of the Base Cabinet MOH/IN connection. Trunk MOH and Extension MOH music source use the same Music on Hold source.
02	Music on Hold Tone Selection	[If Item 1 is 0] 1 = Download File1 2 = Download File2 3 = Download File3 [If Item 1 is 1, 2, or 3] 1~100 = VRS Message Number	1	
03	Audio Gain Setup	1~63 (-15.5 ~ +15.5dB)	32 (0dB)	

Conditions

None

Feature Cross Reference

- Analog Communications Interface (ACI)
- Background Music
- Music on Hold

Program 10 : System Configuration Setup

10-05 : General Purpose Relay Setup

Level:

IN

Description

Use **Program 10-05 : General Purpose Relay Setup** to define which Relay circuits (5~8) on PGD(2)-U10 ADP are used for General Purpose Relay.

Input Data

General Purpose Relay No.	1~8
---------------------------	-----

Item No.	Item	Input Data	Default
01	Slot No. Physical Port of DLCA Sensor Circuit No.	Slot No: 0~24 DLCA Port: 0~16 Relay No: 0, 5~8 <i>After each entry, press the Transfer Key to advance to the next entry.</i>	0 - 0 - 0

Conditions

None

Feature Cross Reference

- Analog Communications Interface (ACI)

Program 10 : System Configuration Setup

10-06 : ISDN-BRI Setup

Level:

IN

Description

Use **Program 10-06 : ISDN - BRI Setup** to configure the ISDN - BRI Terminal Endpoint Identifier (TEI), mode of operation, and Service Profile Identifier (SPID) number for each circuit B-Channels.

Input Data

SLOT Number	1 ~ 24
-------------	--------

ISDN - BRI Circuit	1 ~ 4
--------------------	-------

Item No.	Item	Input Data	Default
01	TEI Selection Select the method the system uses when assigning Terminal Endpoint Identifier (TEI) values to BRI ports.	0 = Select by SPID number 1 = Select by Channel ID number	0
02	DID Mode	0 = Route by Called Party Number 1 = Route by Redirecting Number	0
03	SPID 1	Dial up to 20 digits	No Setting
04	SPID 2	Dial up to 20 digits	No Setting

Conditions

None

Feature Cross Reference

- ISDN Compatibility

Program 10 : System Configuration Setup

10-08 : Pre-Ringing Setup

Level:**IN**

Description

Use **Program 10-08 : Pre-Ringing Setup** to enable or disable pre-ringing for trunk calls. This sets how a trunk initially rings a telephone. With pre-ringing, a burst of ringing occurs as soon as the trunk LED flashes. The call then continues ringing with the normal ring cadence cycle. Without pre-ringing, the call starts ringing only when the normal ring cadence cycle occurs. This may cause a ring delay, depending on when call detection occurs in reference to the ring cycle.

Input Data

Item No.	Description	Input Data	Default
01	Pre-Ringing	0 = No 1 = Yes	0

Conditions

- Used with Analog Trunks only.

Feature Cross Reference

- Central Office Calls, Answering
- Synchronous Ringing

Program 10 : System Configuration Setup

10-09 : DTMF and Dial Tone Circuit Setup

Level:
IN



Description

Use **Program 10-09 : DTMF and Dial Tone Circuit Setup** to allocate the circuits on the CD-CP00-US for either DTMF receiving or dial tone detection. The CD-CP00-US has 32 circuits initially, and an addition 64 circuits are added when a PZ-BS10 is installed. These are used as follows:

- Extension DTMF receiver for single line telephone
- Trunk DTMF receiver for analog trunks, dial tone & busy tone detection for analog trunks

Input Data

Circuit/Resource Number	01~160
-------------------------	--------

Item No.	Input Data	Default Setting
01	0 = Common Use 1 = Extension Only 2 = Trunk Only  <i>The CD-CP00-US has 32 channel DSP resources (receivers) only for basic chassis. When a PZ-BS10 is installed there are 64 DSP resources (receivers) available.</i>  <i>In case 0 = Common is selected and if 14-02-10 (Caller ID receive ability) is set to "Yes", DSP resources are always allocated to analog trunks not analog extensions. If 14-02-10 is set to "No", DSP resources can be used for both analog trunks and analog extensions.</i>	Circuit/Resource 01~08 = 1 (Extensions) Circuit/Resource 09~32 = 2 (Trunks) (Circuit/Resource 33~96 are not used.) Circuit/Resource 97~160 = 0 (Common) When PZ-BS10 is installed, 97~160 are available.

Conditions

None

Feature Cross Reference

- Caller ID
- Central Office Calls, Placing
- Direct Inward Dialing (DID)
- Direct Inward System Access (DISA)
- Tie Lines

Program 10 : System Configuration Setup

10-12 : CD-CP00-US Network Setup

Level:

SA

Description

Use **Program 10-12 : CD-CP00-US Network Setup** to setup the IP Address, Subnet-Mask, and Default Gateway addresses.

Caution! If any IP Address or NIC setting is changed, the system must be reset for the changes to take affect.

Input Data

Item No.	Item	Input Data	Default	Description
01	IP Address	0.0.0.0 ~ 126.255.255.254 128.0.0.1 ~ 191.254.255.254 192.0.0.1 ~ 223.255.255.254	192.168.0.10	Set for CD-CP00-US.
02	Subnet Mask	128.0.0.0 192.0.0.0 224.0.0.0 240.0.0.0 248.0.0.0 252.0.0.0 254.0.0.0 255.0.0.0 255.128.0.0 255.192.0.0 255.224.0.0 255.240.0.0 255.248.0.0 255.252.0.0 255.254.0.0 255.255.0.0 255.255.128.0 255.255.192.0 255.255.224.0 255.255.240.0 255.255.248.0 255.255.252.0 255.255.254.0 255.255.255.0 255.255.255.128 255.255.255.192 255.255.255.224 255.255.255.240 255.255.255.248 255.255.255.252 255.255.255.254 255.255.255.255	255.255.255.0	The setting of Subnet Mask is invalid when all Host Addresses are 0. If the network section is: 0, 127, 128.0, 191.255, 192.0.0, 223.255.255 The setting of Subnet Mask is invalid.
03	Default Gateway	0.0.0.0 ~ 126.255.255.254 128.0.0.1 ~ 191.254.255.254 192.0.0.1 ~ 223.255.255.254	0.0.0.0	IP Address for Router.

Input Data (Continued)

Item No.	Item	Input Data	Default	Description
04	Time Zone	0~24 (0 = -12 Hours and 24 = +12 Hours)	+7 (-5 hours)	Determine the offset from Greenwich Mean Time (GMT) time. Then enter its respective value. For example, Eastern Time (US and Canada) has a GMT offset of -5. The program data would then be 7 (0= -12, 1= -11, 2= -10, 3= -9, 4= -8, 5= -7, 6= -6, 7= -5,24= +12)
05	NIC Interface	0 = Auto Detect 1 = 100Mbps, Full Duplex 2 = 100Mbps, Half Duplex 3 = 10Mbps, Full Duplex 4 = 10Mbps, Half Duplex	0	NIC Auto Negotiate (CD-CP00-US)
06	Network Address Port Translation (NAPT) Router Setup	0 = No (Disable) 1 = Yes (Enable)	0	If using an external NAPT Router or not.
07	NAPT Router IP Address (Default Gateway [WAN])	0.0.0.0 ~ 126.255.255.254 128.0.0.1 ~ 191.255.255.254 192.0.0.1 ~ 223.255.255.254	0.0.0.0	Set the IP address on the WAN side of router.
08	ICMP Redirect	0 = Enable 1 = Disable	0	When receiving ICMP redirect message, this determines if the IP Routing Table updates automatically or not.
09	IP Address	0.0.0.0 ~ 126.255.255.254 128.0.0.1 ~ 191.255.255.254 192.0.0.1 ~ 223.255.255.254	172.16.0.10	Set for IPLA.

Input Data (Continued)

Item No.	Item	Input Data	Default	Description
10	Subnet Mask	128.0.0.0 192.0.0.0 224.0.0.0 240.0.0.0 248.0.0.0 252.0.0.0 254.0.0.0 255.0.0.0 255.128.0.0 255.192.0.0 255.224.0.0 255.240.0.0 255.248.0.0 255.252.0.0 255.254.0.0 255.255.0.0 255.255.128.0 255.255.192.0 255.255.224.0 255.255.240.0 255.255.248.0 255.255.252.0 255.255.254.0 255.255.255.0 255.255.255.128 255.255.255.192 255.255.255.224 255.255.255.240 255.255.255.248 255.255.255.252 255.255.255.254 255.255.255.255	255.255.0.0	Set for IPLA.
11	NIC Setup	0 = Auto Detect 1 = 100Mbps, Full Duplex 2 = 100Mbps, Half Duplex 3 = 10Mbps, Full Duplex 4 = 10Mbps, Half Duplex 5 = 1 Gbps, Full Duplex 6 = 1 Gbps, Half Duplex	0	Set for IPLA.

Conditions

- The system must be reset for these changes to take affect.

Feature Cross Reference

- Voice Over Internet Protocol (VoIP)

Program 10 : System Configuration Setup

10-13 : In-DHCP Server Setup

Level:
SA

Description

Use **Program 10-13 : In-DHCP Server Setup** to setup the DHCP Server built into the CD-CP00-US blade.

Input Data

Item No.	Item	Input Data	Default	Description
01	DHCP Server Mode	0 = Disable 1 = Enable	0	Enable/Disable the built-in DHCP Server.
02	Lease Time	Days 0~255	0 day	Lease Time of the IP address to a client. <i>Press the Transfer Key to increment to the next setting data.</i>
		Hour 0~23	0 hour	
		Minutes 1~59	30 minutes	
05	Last DHCP Data	0 = Disable 1 = Enable	1	If 10-13-01 is enabled, this setting determines if DHCP resource is enabled or disabled.

Conditions

None

Feature Cross Reference

- Voice Over Internet Protocol (VoIP)

Program 10 : System Configuration Setup

10-14 : Managed Network Setup

Level:
SA

Description

Use **Program 10-14 : Managed Network Setup** to set up the range of the IP address which the DHCP Server leases to a client.

Item No.	Item	Input Data	Default	Related Program
01	<p>The Range of the IP address to Lease.</p> <p>When Maximum has not been entered, the maximum value equals the minimum value.</p> <p>When Single is selected in 10-13-04, only 1 scope range can be entered.</p> <p>When Divide Same Network is selected in 10-13-04, a maximum of 10 scope ranges can be entered.</p>	<p>Minimum:</p> <p>1.0.0.1 ~ 126.255.255.254 128.1.0.1 ~ 191.254.255.254 192.0.1.1 ~ 223.255.254.254</p> <p>Maximum:</p> <p>1.0.0.1 ~ 126.255.255.254 128.1.0.1 ~ 191.254.255.254 192.0.1.1 ~ 223.255.254.254</p>	<p>172.16.0.100</p> <p>172.16.5.254</p>	

Conditions

None

Feature Cross Reference

- Voice Over Internet Protocol (VoIP)

Program 10 : System Configuration Setup

10-15 : Client Information Setup

Level:
SA

Description

Use **Program 10-15 : Client Information Setup** to set up the client information when the DHCP server needs to assign a fixed IP address to clients.

Input Data

Client Number	1~512
---------------	-------

Item No.	Item	Input Data	Default
01	The IP address should be assigned out of the scope range set up in Program 10-14.	MAC: 00-00-00-00-00-00 ~ FF-FF-FF-FF-FF-FF	00-00-00-00-00-00
		1.0.0.0 ~ 126.255.255.254 128.0.0.1 ~ 191.255.255.254 192.0.0.1 ~ 223.255.255.254	0.0.0.0

Conditions

None

Feature Cross Reference

- Voice Over Internet Protocol (VoIP)

Program 10 : System Configuration Setup

10-16 : Option Information Setup

Level:

SA

Description

Use **Program 10-16 : Option Information Setup** to set up the option given from the DHCP server to each client.

Input Data

Item No.	Item	Input Data	Default
01	Router Set the Router IP address.	Code number 0~255	3 (Fixed)
		IP address 0.0.0.0 ~ 126.255.255.254 128.0.0.1 ~ 191.255.255.254 192.0.0.1 ~ 223.255.255.254	0.0.0.0
02	DNS Server Set IP address of DNS Server.	Code number 0~255	6 (Fixed)
		IP address 0.0.0.0 ~ 126.255.255.254 128.0.0.1 ~ 191.255.255.254 192.0.0.1 ~ 223.255.255.254	0.0.0.0
03	TFTP Server Set the name for the TFTP Server.	Code number 0~255	66 (Fixed)
		Maximum 64 character strings	No setting
05	MGC	Code number 0~255	129 (Fixed)
		IP address 0.0.0.0 ~ 126.255.255.254 128.0.0.1 ~ 191.255.255.254 192.0.0.1 ~ 223.255.255.254	172.16.0.10
06	Client Host Name Set the Client Host Name.	Code number 0~255	12 (Fixed)
		Maximum 64 character strings	No setting
07	DNS Domain Name Set the DNS Domain Name.	Code number 0~255	15 (Fixed)
		Maximum 20 character strings	No setting

Input Data (Continued)

Item No.	Item	Input Data	Default
08	Download Protocol Set Download Protocol used for AutoConfig (for DT700 Series).	Code number 0~255	43 (Fixed)
		Sub code number	163
		1 = FTP 2 = HTTP	1
09	Encryption Information Set an Encryption Information used for AutoConfig (for DT700 series).	Code number 0~255	43 (Fixed)
		Sub code number	164
		Maximum 128 character strings	No setting
10	FTP Server Address Set a FTP Server Address used for AutoConfig.	Code number 0~255	43 (Fixed)
		Sub code number	141
		IP address 0.0.0.0 ~ 126.255.255.254 128.0.0.1 ~ 191.255.255.254 192.0.0.1 ~ 223.255.255.254	0.0.0.0
11	Config File Name Set a File Name used for AutoConfig.	Code number 0~255	43 (Fixed)
		Sub code number	151
		Maximum 15 character strings	No setting
12	Vender Class ID	Code number 0~255	60 (Fixed)
		Maximum 256 character strings	NECDT700
13	SNMP Server	Code number 0~255	69 (Fixed)
		IP address 0.0.0.0 ~ 126.255.255.254 128.0.0.1 ~ 191.255.255.254 192.0.0.1 ~ 223.255.255.254	0.0.0.0
14	POP3 Server	Code number 0~255	70 (Fixed)
		IP address 0.0.0.0 ~ 126.255.255.254 128.0.0.1 ~ 191.255.255.254 192.0.0.1 ~ 223.255.255.254	0.0.0.0
16	SIP Server (IP Address)	Code number 0~255	120 (Fixed)
		IP address 0.0.0.0 ~ 126.255.255.254 128.0.0.1 ~ 191.255.255.254 192.0.0.1 ~ 223.255.255.254	172.16.0.10

Input Data (Continued)

Item No.	Item	Input Data	Default
17	SIP Server (Domain Name)	Code number 0~255	120 (Fixed)
		Maximum 20 character strings	No setting
18	FTP Server	Code number 0~255	141 (Fixed)
		IP address 0.0.0.0 ~ 126.255.255.254 128.0.0.1 ~ 191.255.255.254 192.0.0.1 ~ 223.255.255.254	0.0.0.0
19	Config File Name	Code number 0~255	151 (Fixed)
		Maximum 15 character strings	No setting
20	LDS Server 1	Code number 0~255	162 (Fixed)
		IP address 0.0.0.0 ~ 126.255.255.254 128.0.0.1 ~ 191.255.255.254 192.0.0.1 ~ 223.255.255.254	0.0.0.0
21	LDS Server 2	Code number 0~255	162 (Fixed)
		IP address 0.0.0.0 ~ 126.255.255.254 128.0.0.1 ~ 191.255.255.254 192.0.0.1 ~ 223.255.255.254	0.0.0.0
22	LDS Server 3	Code number 0~255	162 (Fixed)
		IP address 0.0.0.0 ~ 126.255.255.254 128.0.0.1 ~ 191.255.255.254 192.0.0.1 ~ 223.255.255.254	0.0.0.0
23	LDS Server 4	Code number 0~255	162 (Fixed)
		IP address 0.0.0.0 ~ 126.255.255.254 128.0.0.1 ~ 191.255.255.254 192.0.0.1 ~ 223.255.255.254	0.0.0.0
24	Next Server IP Address	IP address 0.0.0.0 ~ 126.255.255.254 128.0.0.1 ~ 191.255.255.254 192.0.0.1 ~ 223.255.255.254	0.0.0.0
27	SIP Server Receive Port	Code number 0~255	168 (Fixed)
		Port: 1~65535	5080

Conditions

None

Feature Cross Reference

- Voice Over Internet Protocol (VoIP)

Program 10 : System Configuration Setup

10-17 : H.323 Gatekeeper Setup

Level:

SA

Description

Use **Program 10-17 : H.323 Gatekeeper Setup** to set the H.323 Gatekeeper information.

Item	Name	Input Data	Default
01	Gatekeeper Mode Set IP Address either automatically or manually if using an external Gatekeeper.	0 = No Gatekeeper 1 = Automatic 2 = Manual	0
02	Gatekeeper IP Address	0.0.0.0 ~ 126.255.255.254 128.0.0.1 ~ 191.255.255.254 192.0.0.1 ~ 223.255.255.254	0.0.0.0
04	Preferred Gatekeeper When 10-17-01 is set to 1, use this to set the preferred ID of multiple Gatekeepers.	Maximum 124 characters	No setting

Conditions

None

Feature Cross Reference

IP Trunk – H.323

Program 10 : System Configuration Setup

10-18 : H.323 Alias Address Setup

Level:

SA

Description

Use **Program 10-18 : H.323 Alias Address Setup** to set the alias address registered to the outside H.323 Gatekeeper.

Input Data

Number of Alias	1~6
-----------------	-----

Item	Name	Input Data	Default
01	Alias Address Set the telephone number (Alias Address) to external gatekeeper.	Dial up to 12 digits (0~9, *, #)	No setting
02	Alias Address Type Set the Alias Address Type to external gatekeeper.	0 = E164	0

Conditions

None

Feature Cross Reference

- IP Trunk – H.323

Program 10 : System Configuration Setup

10-19 : VoIP DSP Resource Selection

Level:
SA

Description

Use **Program 10-19 : VoIP DSP Resource Selection** to define the criteria for each DSP resource on the VoIP blade.

Input Data

Slot Number	1
-------------	---

Input Data

DSP Resource Number	01~128
---------------------	--------

Input Data

Item No.	Item	Input Data	Default
01	VoIP DSP Resource Selection	0 = Common use for both IP extensions and trunks 1 = IP Extension 2 = SIP Trunk 3 = CCIS 4 = Use for NetLink 5 = Blocked 6 = Common without Unicast Paging 7 = Multicast Paging 8 = Unicast Paging	Resource 1 = 1 Resource 2~128 = 0

Conditions

None

Feature Cross Reference

None

Program 10 : System Configuration Setup

10-20 : LAN Setup for External Equipment

Level:
IN

Description

Use **Program 10-20 : LAN Setup for External Equipment** to define the TCP port/ address/etc. for communicating to external equipment.

Input Data

Type of External Equipment	1 = CTI Server 2 = ACD MIS 3 = Not Used 4 = Networking System 5 = SMDR Output 6 = DIM Output 7 = Reserved 8 = Reserved 9 = 1st Party CTI 10 = ACD Agent Control 11 = O&M Server 12 = Traffic Report Output 13 = Room Data Output for Hotel Service 14 = IP-DECT Directory Access
----------------------------	---

Item No.	Item	Input Data	Default
01	TCP Port	0~65535	External Device 1 (CTI Server) = 0 External Device 2 (ACD MIS) = 4000 External Device 5 (SMDR Output) = 0 External Device 6 (DIM Output) = 0 External Device 11 (O&M Server) = 8010 External Device 12 (Traffic Report Output) = 0 External Device 13 (Room Data Output for Hotel Service) = 0 External Device 14 (IP-DECT Directory Access) = 0
03	Keep Alive Time	1~255 (sec)	30

Conditions

None

Feature Cross Reference

None

Program 10 : System Configuration Setup

10-21 : CD-CP00-US Hardware Setup

Level:
IN

Description

Use **Program 10-21 : CD-CP00-US Hardware Setup** to set up various hardware, such as the baud rate of COM port and the switch for control on CD-CP00-US blade.

Input Data

Item No.	Item	Input Data	Default	Related Program
04	External Source I/O Selection on CD-CP00-US Determines the external music source input/output selection for CD-CP00-US CN8 and CN9.	0 = External MOH (CN8)/ External Speaker(CN9) 1 = BGM source (CN8)/ External Speaker(CN9) 2 = External MOH (CN8)/BGM source (CN9) <i>Relationships between CN number and Relay number are as follows:</i> CN8 = Relay2 CN9 = Relay1	1	
05	General Purpose Relay Switch Selection on CD-CP00-US	0 = Off 1 = Relay 1 on CD-CP00-US 2 = Relay 2 on CD-CP00-US	0	

Conditions

None

Feature Cross Reference

None

Program 10 : System Configuration Setup

10-23 : SIP System Interconnection Setup

Level:
IN

Description

Use **Program 10-23 : SIP System Interconnection Setup** to determine if the system is interconnected and define the IP address of another system, call control port number and alias address for SV8100 system interconnection.

Input Data

System Number	001~1000
---------------	----------

Input Data

Item No.	Item	Input Data	Default
01	System Interconnection	0 = No (Disable) 1 = Yes (Enable)	0
02	IP Address	0.0.0.0 ~ 126.255.255.254 128.0.0.1 ~ 191.255.255.254 192.0.0.1 ~ 223.255.255.254	0.0.0.0
03	Call Procedure Port	1~65535	1720
04	Dial Number	Up to 12 digits (0~9)	None

Conditions

None

Feature Cross Reference

None

Program 10 : System Configuration Setup

10-24 : Daylight Savings Setup

Level:
IN

Description

Use **Program 10-24 : Daylight Savings Setup** to set the options for daylight savings. As the telephone system is used globally, these settings define when the system should automatically adjust for daylight savings as it applies to the region in which the system is installed.

Input Data

Item No.	Item	Input Data	Default
01	Daylight Savings Mode Enable/Disable the system ability to adjust the time for daylight savings/standard time.	0 = Disable 1 = Enable	1
02	Time for Daylight Savings Enter the time of day when the system should adjust for daylight savings time.	00:00~23:59	02:00
03	Start Month (Summer Time) Enter the month when the system should adjust the time for daylight savings time (01~12).	1~12 (Jan = 1, 2 = Feb, etc.)	3
04	Start of Week Enter the week of the month when the system should adjust the time for daylight savings time. The week will start on the day listed in 10-24-05.	0 = Last Week of Month 0~5	2
05	Start of Week Day Enter the day of the week when the system should adjust the time for daylight savings time (01 = Sunday, 02 = Monday, etc.).	1~7 (Sun = 1, Mon = 2, etc.)	1
06	End of Month Enter the month when the system should adjust the time for standard time (01~12).	1~12 (Jan = 1, 2 = Feb, etc.)	11
07	End of Week Enter the week of the month when the system should adjust the time for standard time. The week will start on the Day listed in 10-24-08.	0 = Last Week of Month 0~5	1

Input Data (Continued)

Item No.	Item	Input Data	Default
08	End of Week Day Enter the day of the week when the system should adjust the time for daylight savings time (01 = Sunday, 02 = Monday, etc.).	1~7 (Sun = 1, Mon = 2, etc.)	1

Conditions

None

Feature Cross Reference

- Clock/Calendar Display

Program 10 : System Configuration Setup

10-25 : H.323 Gateway Prefix Setup

Level:
IN

Description

Use **Program 10-25 : H.323 Gateway Prefix Setup** to set the gateway prefix registered to the outside gatekeeper.

Input Data

Item No.	Item	Input Data	Default
01	Gateway Prefix Entry	0 = Off 1 = On	0
02	Gateway Prefix Value	Up to 12 digits (0~9, *, #)	No setting

Conditions

None

Feature Cross Reference

None

Program 10 : System Configuration Setup

10-26 : IP System Operation Setup

Level:
IN

Description

Use **Program 10-26 : IP System Operation Setup** to enable or disable the Peer to Peer feature for SIP MLT and SIP IP stations.

Input Data

Item No.	Item	Input Data	Default
01	Peer to Peer Mode	0 = Off 1 = On	1
02	RTP Forwarding Mode	0 = Disable 1 = Enable	0
03	SIP Peer to Peer Mode	0 = Off 1 = On	1
04	DT700 Peer to Peer Mode	0 = Off 1 = On	1

Conditions

- Disabling 10-26-04 results in SIP MLT Station-to-SIP MLT Station calls using a DSP resource. (V2000 or higher)
- SIP-to-SIP MLT Station does not support Peer to Peer function and results in using a DSP resource. (V1200 or lower)
- Disabling 10-26-03 results in SIP IP Station-to-SIP IP Station calls using a DSP resource.

Feature Cross Reference

None

Program 10 : System Configuration Setup

10-28 : SIP System Information Setup

Level:
IN

Description

Use **Program 10-28 : SIP System Information Setup** to set up basic SIP trunking.

Input Data

Item No.	Item	Input Data	Default
01	Domain Name Set the domain name of the SIP-URL.	Up to 64 Characters (ex.:UserID@HostName.DomainName)	None
02	Host Name Set the host name of the SIP-URL.	Up to 48 Characters (ex.:UserID@HostName.DomainName)	None
03	Transport Protocol Set the protocol for the connection.	0 = UDP 1 = TCP	0
04	UserID User ID in the SIP Invite Setup message. Use it for outbound caller ID information if no information is assigned in commands 21-17, 21-19, 15-16, 14-12, and 10-36. A call cannot be completed across the span if there is no outbound CID info. The reason for this is: the from and display portions of the invite message would be blank, and it would not know where the call originated from.	Up to 32 Characters When assigning the User ID, the ID may contain only alpha characters. (A space and/or special characters are not allowed in the User ID field). (ex.:UserID@HostName.DomainName)	None

Input Data

05	Domain Assignment If the information from Telco was a domain name (siptrunk@sip.com) then set to domain. If the information for Telco was a IP address then set to IP Address.	0 = IP Address 1 = Domain Name	0
06	IP Trunk Port Binding Trunk port binding is only used for SIP trunks to the provider in Non-Registration Mode only. When this is disabled, an inbound call comes in and follows your DID routing but it comes in on the first available trunk. When enabled, the inbound call comes in and follows your normal DID routing but maps to that specified trunk. If that trunk is busy, it sends back a busy unless you build a hunt group. To build the hunt group, it references command 14-12-02 (pilot register ID). This points you to command 10-36-02. All numbers with the same pilot are in the same hunt group.	0 = Disable 1 = Enable	0

Conditions

None

Feature Cross Reference

None

Program 10 : System Configuration Setup

10-29 : SIP Server Information Setup

Level:
IN

Description

Use **Program 10-29 : SIP Server Information Setup** to define the SIP Proxy setup for outbound/inbound. The 10-29 commands are not used in non-registration mode.

 *If entries are made in Program 10-29-xx for a SIP Server and the SIP Server is then removed or not used, the entries in Program 10-29-xx must be set back to their default settings. Even if 10-29-01 is set to 0 (off), the SV8100 still checks the settings in the remaining 10-29 programs.*

Input Data

Item No.	Item	Input Data	Default
01	Default Proxy (Outbound) Set whether or not the SIP message is always sent through the Default Proxy.	0 = Off 1 = On	0
02	Default Proxy (Inbound) Need to be registered in registration mode. Set whether or not the SIP message is always received through the Default Proxy.	0 = Off 1 = On	0
03	Default Proxy IP Address This is optional and used if the provider gives you a proxy address that is different than the registration address. If the provider is using domain names instead of IP addresses, leave this at default.	0.0.0.0 ~ 126.255.255.254 128.0.0.1 ~ 191.255.255.254 192.0.0.1 ~ 223.255.255.254	0.0.0.0

Input Data

Item No.	Item	Input Data	Default
04	Default Proxy Port Number Set the port number of the Default Proxy.	0 ~ 65535	5060
05	Registrar Mode Set the mode registered in the registration server.	0 = None 1 = Manual	0
06	Registrar IP Address Set the IP address of the SIP registration server.	0.0.0.0 ~ 126.255.255.254 128.0.0.1 ~ 191.255.255.254 192.0.0.1 ~ 223.255.255.254	0.0.0.0
07	Registrar Port Number Set the port number of the SIP registration server.	0 ~ 65535	5060
08	DNS Server Mode Determine if the DNS server is used.	0 = Off 1 = On	0
09	DNS Server IP Address If 10-29-08 is 1, this is effective. Set the IP address of the DNS server.	0.0.0.0 ~ 126.255.255.254 128.0.0.1 ~ 191.255.255.254 192.0.0.1 ~ 223.255.255.254	0.0.0.0
10	DNS Port Number If 10-29-08 is 1, this is effective. Set the the port number of the DNS server.	0 ~ 65535	53
11	Registrar Domain Name Set the domain name of the registration server.	Up to 128 Characters	None
12	Domain Name Specify the domain name of the SIP server.	Up to 64 Characters	None
13	Proxy Host Name Specify the host name of the SIP server.	Up to 48 Characters	None

Input Data

Item No.	Item	Input Data	Default
14	SIP Carrier Choice Select the carrier type of the SIP server.	0 ~ 7 0 = Standard 1 = Carrier A 2 = Carrier B 3 = Carrier C 4 = Carrier D 5 = Carrier E 6 = Carrier F 7 = Carrier G	0
15	Registration Expiry (Expire) Time Set the expiration time when the SIP trunk registers to the SIP server. When half the time set here passes, the registration update is automatically done.	120 ~ 65535 seconds	3600
16	Register Sub Mode Prevents an invalid Invite message. If "the register information that SV8100 send to SIP server" and "the Invite information that SV8100 receive" are different, SV8100 sends "404 Not Found" Message. If PRG10-29-05 Register Mode is 0:Off, it is necessary to set 0:off in PRG10-29-16.	0 = Off (Allow invalid Invite message) 1 = On (Deny invalid Invite message)	0
17	DNS Source Port (10-29-08 must be On) Set the DNS source port number.	0~65535	53

Conditions

None

Feature Cross Reference

None

Program 10 : System Configuration Setup

10-30 : SIP Authentication Information Setup

Level:
IN

Description

Use **Program 10-30 : SIP Authentication Information Setup** to set the authentication options for SIP trunks.

Input Data

Item No.	Item	Input Data	Default
02	User Name Set the user name of the SIP trunk.	Up to 64 Characters	None
03	Password Set the SIP trunk password.	Up to 32 Characters	None
04	Authentication Trial Select how many times it tries an authenticate before timing out and not registering.	0 ~ 9	1

Conditions

None

Feature Cross Reference

None

Program 10 : System Configuration Setup

10-33 : SIP Registrar/Proxy Information Basic Setup

Level:
IN

Description

Use **Program 10-33 : SIP Registrar/Proxy Information Basic Setup** to set the registrar/proxy options for SIP extensions.

Input Data

Item No.	Item	Input Data	Default
01	Registration Expire Time After this time expires, the UAs are forced to reregister with the CPU. This allows the CPU to keep a current location of the entire end UAs.	60 ~ 65535	3600
02	Authentication Mode Check here if a password is desired for the IP SIP phones to register. When checked, 15-05-16 must have a password entered and the SIP phone must have the same password. When using Authentication, the station number is the authorization name.	0 = Disable 1 = Enable	0
03	Registrar/Proxy Domain Name Set the domain name of the SIP proxy.	Up to 64 Characters	None

Input Data

04	Registrar/Proxy Host Name Set the domain name of the SIP proxy.	Up to 48 Characters	None
----	---	---------------------	------

Conditions

None

Feature Cross Reference

None

Program 10 : System Configuration Setup

10-36 : SIP Trunk Registration Information Setup

Level:
IN

Description

Use **Program 10-36 : SIP Trunk Registration Information Setup** to set the SIP trunk registration information.

Input Data

Register ID	1~31
-------------	------

Input Data

Item No.	Item	Input Data	Default
01	Registration Determine if the SIP trunk information is registered.	0 = Disable 1 = Enable	0
02	User ID Set the SIP trunk User ID.	Up to 32 Characters	None
03	Authentication User ID Set the SIP trunk Authentication User ID.	Up to 64 Characters	None
04	Authentication Password Set the SIP trunk authentication password.	Up to 32 Characters	None

Conditions

None

Feature Cross Reference

None

Program 10 : System Configuration Setup

10-37 : UPnP Setup

Level:

IN

Description

Use **Program 10-37 : UPnP Setup** to set the UPnP (Universal Plug and Play) options for SIP trunks.

Input Data

Item No.	Item	Input Data	Default
01	UPnP Mode Router must support UPnP.	0 = Disable 1 = Enable	0
02	Retry Time	0,60 ~ 3600 (1~59 cannot be input)	60

Conditions

None

Feature Cross Reference

None

Program 10 : System Configuration Setup

10-38 : BGM Resource Setup

Level:
IN

Description

Use **Program 10-38 : BGM Resource Setup** to configure the Background Music Source input.

Input Data

Item No.	Item	Input Data	Default
01	BGM Resource Type	0 = CD-CP00-US (MOH/IN) 1 = ACI Port	0
02	ACI Port Number for BGM Source (only used if 10-38-01 is set to 1)	0 ~ 96	0

Conditions

None

Feature Cross Reference

- Analog Communications Interface (ACI)
- Background Music

Program 10 : System Configuration Setup

10-39 : Fractional Setup

Level:
IN

Description

Use **Program 10-39 : Fractional Setup** to enable or disable the ability to use fractional T1 or PRI.

Input Data

Item No.	Item	Input Data	Default
01	Fractional	0 = Disable 1 = Enable	0

Conditions

None

Feature Cross Reference

None

Program 10 : System Configuration Setup

10-40 : IP Trunk Availability

Level:

IN

Description

Use **Program 10-40 : IP Trunk Availability** to enable or disable the ability to use SIP trunks and assign the number of ports if IP Trunk is enabled.

Input Data

Slot Number	1
-------------	---

Input Data

Item No.	Item	Input Data	Default
01	IP Trunk Availability	0 = Disable 1 = Enable	0
02	Number of Ports	0~200	0
04	Number of IP CCIS Ports	0~200	0

Conditions

None

Feature Cross Reference

None

Program 10 : System Configuration Setup

10-42 : Virtual Loop Back Port Setting

Level:
IN

Description

Use **Program 10-42 : Virtual Loop Back Port Setting** to set the data for the Virtual Loop Back Port.

Input Data

Item No.	Item	Input Data	Default
01	Number of Loop Back Ports	0~30 (0 = No setting)	0
02	Logical Trunk Port Number	0~168	0
03	Logical Station Port Number	0~480	0
04	Layer 3 Timer Type	1~5	1
05	Calling Party Number	0 = No 1 = Yes	1
06	--- Not Used ---		
07	--- Not Used ---		

Conditions
None

Feature Cross Reference

None

Program 10 : System Configuration Setup

10-45 : IP Routing Table Setup

Level:
IN

Description

Use **Program 10-45 : IP Routing Table Setup** to set up the IP Routing Table.

Input Data

Routing Table Number	001~100
----------------------	---------

Input Data

Item No.	Item	Input Data	Default
01	Network Address	0.0.0.0 ~ 126.255.255.254 128.0.0.0 ~ 191.254.255.254 192.0.0.0 ~ 223.255.255.254	0.0.0.0
02	Subnet Mask	128.0.0.0 192.0.0.0 224.0.0.0 240.0.0.0 248.0.0.0 252.0.0.0 254.0.0.0 255.0.0.0 255.128.0.0 255.192.0.0 255.224.0.0 255.240.0.0 255.248.0.0 255.252.0.0 255.254.0.0 255.255.0.0 255.255.128.0 255.255.192.0 255.255.224.0 255.255.240.0 255.255.248.0 255.255.252.0 255.255.254.0 255.255.255.0 255.255.255.128 255.255.255.192 255.255.255.224 255.255.255.240 255.255.255.248 255.255.255.252 255.255.255.254 255.255.255.255	0.0.0.0
03	Default Gateway	0.0.0.0 ~ 126.255.255.254 128.0.0.1 ~ 191.254.255.254 192.0.0.1 ~ 223.255.255.254	0.0.0.0

Conditions

None

Feature Cross Reference

None

Program 10 : System Configuration Setup

10-46 : DT700 Server Information Setup

Level:
IN

Description

Use **Program 10-46 : DT700 Server Information Setup** to setup the information of SIP Multiline (DT700 series) Server.

Input Data

Item No.	Item	Input Data	Default	Related Program
01	<p>Register Mode</p> <p>Normal:: When the phone boots up, it reports the ext. assigned in the phone or chooses the next available extension in the system. Password is not required.</p> <p>Auto: If set to Auto, the SIP user name and password must be entered on the actual IP phone. These settings must match 84-22/15-05-27, or the phone does not come on-line.</p> <p>Manual: When the phone boots up, it prompts user to enter a user ID and password before logging in. If the user name and password are programmed in the SIP User settings in the telephone, it comes up without prompting the user. It checks this user ID/ password against 84-22/15-05-27. If there is no match, the phone does not come on-line.</p>	<p>0 = Normal 1 = Auto 2 = Manual</p>	0	
04	<p>Server Name</p> <p>Assign the Server name to be used in the SIP URL.</p>	Up to 32 characters	sipphd	

Input Data

Item No.	Item	Input Data	Default	Related Program
06	Register Port Assign the port number in which the SIP messages are sent to on the IPLA. This same port number must be assigned in the SIP Multiline terminals. If this command is changed, it requires a CPU reset.	0~65535	5080	
07	Encryption Mode	0 = Off 1 = On	0	
08	Encryption Type	0 = Mode1	0	
09	One Time Password	Up to 10 characters (0~9, *, #)	None	10-46-07
10	Start Port	1~512	1	10-46-01
11	Multicast IP Address Set the Multicast IP address so that two or more main devices don't overlap on the same network, or if Multicast is used by other IP services.	224.0.0.0~ 239.255.255.255	224.0.0.10	

Input Data

Item No.	Item	Input Data	Default	Related Program
12	<p>Multicast Port</p> <p>The port number that is used for paging will change based upon the following information.</p> <p>The formula for the ports that will be used is:</p> <p>Starting port number assigned in 10-46-12 + Management ID * 2</p> <p>The value of the Management ID is from 1 to 64. The Management ID will count up sequentially, for example:</p> <p>10-46-12 = 3000</p> <p>The first page the system makes will use port 30002 (3000 + 1*2).</p> <p>The second page the system makes will use port 30004 (3000 + 2*2).</p> <p>The Management ID will increment every time the page is used. After the Management ID reaches 64 it will start over, so the next page will use Management ID 1.</p> <p>The max. port starting from 3000 would be 30128 (3000 +64*2)</p>	0~65535	30000	
13	Subscribe Session Port	0~65535	5081	
14	<p>NAT Mode</p> <p>When the system controls the SIP multiline terminal via the NAT router, this system data is set to On.</p>	0 = Off 1 = On	0	

Conditions

None

Feature Cross Reference

None

Program 10 : System Configuration Setup

10-47 : Terminal License Server Information Setup

Level:
IN

Description

Use **Program 10-47 : Terminal License Server Information Setup** to setup the information of Terminal License Server.

Input Data

Item No.	Item	Input Data	Default	Description
01	Register Port of TCP I/F	0~65535	6080	
02	TCP Keep Alive Time	1~255 seconds	5	

Conditions

None

Feature Cross Reference

None

Program 10 : System Configuration Setup

10-48 : License Activation

Level:
IN

Description

Use **Program 10-48 : License Activation** to turn on the license issued from the license server.

Input Data

Item No.	Item	Input Data	Default
01	Software Key Code	20-digit character	None
02	Activation Code	8-digit hexadecimal number	None
03	Feature Code	7-digit number	None

Key Operation for Item 03

Transfer key:

Edit next feature code

- Up to 10 feature codes are possible to input at once.
- Register the license when 10th feature code is edited.

Soft Key2 (BACK):

Edit previous feature code

Soft Key3 (SUBMIT):

Register the license

Conditions

None

Feature Cross Reference

None

Program 10 : System Configuration Setup

10-49 : License File Activation

Level:
IN

Description

Use **Program 10-49 : License File Activation** to enable the command to save the license file via USB memory which is issued from the license server.

Input Data

Item No.	Item	Input Data
01	Save License File on USB Drive	Dial 1 + TRF (Press TRF to cancel)

Conditions

None

Feature Cross Reference

None

Program 10 : System Configuration Setup

10-50 : License Information

Level:
IN

Description

Use **Program 10-50 : License Information** to confirm license information that is stored in a system.

Input Data

Item No.	Item	Read Data
01	License Name	None
02	License Quantity	0~32767
03	Free License Quantity	0~32767
04	Free License Remaining Days	0~9999

Refer to the following table to assist with licensing information.

Table 2-2 License Information

License Code	License Name	Reset Required	Min	Max	Note
0001	Max. Port	Yes	On/Off		
0002	NetLink	Yes	1	49	
0007	Hotel/Motel (PMS)	Yes	On/Off		
0008	SMDR		On/Off		
0009	Remote Upgrade	Yes	On		USB Drive required to load software
0014	256 Port	Yes	On/Off		
0030	Encryption		On/Off		
0031	V3000 Enhanced		On/Off		
0111	1stPartyCTI Ether		1	128	
0112	3rdPartyCTI Clie	Yes	On/Off		
0123	SOAI Interface		On/Off		
0141	DTPlusWare User		1	64	
1001	VRS		1	16	
1002	InMail		1	8	
1011	InMail Multi Lan		1	20	
1013	Email Notify	No	On/Off		
1014	InMail Email Clnt	No	0	512	InMail Email Clients
1401	UMS Port	No	1	16	
1402	UMS Fax Port		1	4	
1403	UMS TTS Port		1	6	
1404	UMS Client		1	512	
1406	UMS Multi Languag		1	25	
1407	UMS Hosp. and PMS		On/Off		
1408	UMS Hosp. Languag		1	10	
1409	UMS Amis/Plus Net		On/Off		

Table 2-2 License Information (Continued)

License Code	License Name	Reset Required	Min	Max	Note
1410	UMS TTS Language		1	10	
1424	UMS LITE 2Basic		On/Off		
1425	UMS LITE Ch		1	8	UMS Port License. The Lite license does not support Text-to-speech, Networking and will support up to two ports for fax.
1426	UMS LITE 2UP		On/Off		2-Port LITE Upgrade Kit.
1427	UMS LITE FULL		On/Off		Upgrade from UMS LITE to FULL License.
2001	ACD		On/Off		
2102	ACD-MIS Basic		On/Off		
2103	ACD-MIS Add.Monit		1	4	
2104	ACD-MIS Agent		1	197	
3000	CA-Basic		On/Off		
3001	CA-256 Station		On/Off		
3002	CA-Up 20 to 256		On/Off		
3003	CA-Network Client		1	999	
3004	CA-AddRemote Site		1	999	
3005	CA-RemoteSiteSoft		1	999	
3006	CA-Traffic Analys		On/Off		
3007	CA-PMS Intergratio		On/Off		
3008	CA-Web Reporting		On/Off		

Table 2-2 License Information (Continued)

License Code	License Name	Reset Required	Min	Max	Note
3009	CA-IPKII CA Migra		On/Off		
3010	CA-IPKII CESMigra		On/Off		
3013	CA-Add Stations		1	256	
3200	IP Recorder Basic				
3201	IP Recorder Basic SUPV		1	256	
3202	IP Recorder Basic Port		1	256	
5001	IP Trunk		1	128	Limited by IPL Channels
5101	IP Terminal Basic		1	512	Limited by IPL Channels
5102	IP Terminal SoftPhone		1	128	Limited by IPL Channels
5111	IP Terminal Advan		1	512	Limited by IPL Channels
5301	SoftPhone		1	128	
5303	SoftPhone Enhance		1	128	
5304	Shared Services		1	128	
5305	Desktop Client		1	128	
6000	PVA-CONF Port		1	16	
6101	PVA-IVR Port		1	16	
6200	PVA-CCIS Port		1	200	

Conditions

- Confirm license by entering Feature Code No. (0~9999)

Feature Cross Reference

None

Program 10 : System Configuration Setup

10-51 : PRI/T1 Selection of CD-PRTA

Level:
IN

Description

Use **Program 10-51 : PRI/T1 Selection of CD-PRTA** to select whether the CD-PRTA works as PRI or T1.

Input Data

System ID	0~50
-----------	------

Input Data

Slot Number	01~24
-------------	-------

Input Data

Item No.	Item	Input Data	Default
01	PRI/T1 Selection Choose whether the CD-PRTA works as PRI or T1.	0 = PRI 1 = T1	0 = PRI

Conditions

None

Feature Cross Reference

None

Program 10 : System Configuration Setup

10-52 : Free/Demo License Information

Level:
IN

Description

Use **Program 10-52 : Free/Demo License Information** to display information on free of charge/Demo license.

Input Data

Item No.	Item	Read Data
01	Remaining days of Free/Demo License	0~9999

Conditions

None

Feature Cross Reference

None

Program 10 : System Configuration Setup

10-54 : License Configuration for Each Package

Level:
IN

Description

Use **Program 10-54 : License Configuration for Each Package** to set the license information for each unit.

Input Data

Slot Number	1~24
-------------	------

Input Data

License Index Number	1~32
----------------------	------

Input Data

Item No.	Item	Read Data
01	License Code	0000~9999
02	License Quantity	0~255

Conditions

None

Feature Cross Reference

None

Program 10 : System Configuration Setup

10-55 : Package Network Setup

Level:
IN

Description

Use **Program 10-55 : Package Network Setup** to set the network information for each unit. This program sets the SPOE of each package.

Input Data

Slot Number	1~24
-------------	------

Input Data

Item No.	Item	Input Data	Default
01	IP Address	0.0.0.0~126.255.255.254 128.0.0.1~191.255.255.254 192.0.0.1~223.255.255.254	172.16.1.100
02	--- Not Used ---		
03	Main/Add-on	0 = Main 1 = Add-on	1
04	Sub Net Mask	128.0.0.0 192.0.0.0 224.0.0.0 240.0.0.0 248.0.0.0 252.0.0.0 254.0.0.0 255.0.0.0 255.128.0.0 255.192.0.0 255.224.0.0 255.240.0.0 255.248.0.0 255.252.0.0 255.254.0.0 255.255.0.0 255.255.128.0 255.255.192.0 255.255.224.0 255.255.240.0 255.255.248.0 255.255.252.0 255.255.254.0 255.255.255.0 255.255.255.128 255.255.255.192 255.255.255.224 255.255.255.240 255.255.255.248 255.255.255.252 255.255.255.254 255.255.255.255	255.255.0.0
05	Default Gateway	0.0.0.0~126.255.255.254 128.0.0.1~191.255.255.254 192.0.0.1~223.255.255.254	0.0.0.0

Conditions

None

Feature Cross Reference

None

Program 10 : System Configuration Setup

10-56 : XML Portal IP Phone

Level:

IN

Description

Use **Program 10-56 : XML Portal IP Phone** to set the contents of XML portal page provided to the IP Phone. The XML Portal Page is included in the XML application name and URL Link information. XML URL Link Information can be set for up to five system bases.

Input Data

XML URL Information Link	1~5
--------------------------	-----

Input Data

Item No.	Item	Input Data	Default
01	Name	Up to 40 characters.	No Setting
02	URL	Up to 256 characters.	No Setting

Conditions

None

Feature Cross Reference

None

Program 10 : System Configuration Setup

10-58 : Network Address

Level:
IN

Description

Use **Program 10-58 : Network Address** to set the local network address when the SIP multiline terminal connects the system via a local router.

Input Data

Area Table	1~8
------------	-----

Input Data

Item No.	Item	Input Data	Default	Related Program
01	Network Address Sets local network address.	0.0.0.0 ~ 126.255.255.254 128.0.0.1 ~ 191.255.255.254 192.0.0.1 ~ 223.255.255.254	0.0.0.0	10-46-14
02	Subnet Mask Sets local subnet mask.	248.0.0.0 / 252.0.0.0 / 254.0.0.0 / 255.0.0.0 255.128.0.0 / 255.192.0.0 / 255.224.0.0 255.240.0.0 / 255.248.0.0 / 255.252.0.0 255.254.0.0 / 255.255.0.0 / 255.255.128.0 255.255.192.0 / 255.255.224.0 255.255.240.0 / 255.255.248.0 255.255.252.0 / 255.255.254.0 255.255.255.0 / 255.255.255.128 255.255.255.192 / 255.255.255.224 255.255.255.240 / 255.255.255.248 255.255.255.252 / 255.255.255.254	0.0.0.0	10-46-14

Conditions

None

Feature Cross Reference

None

THIS PAGE INTENTIONALLY LEFT BLANK

Program 11 : System Numbering

11-01 : System Numbering

Level:
IN

Program

11

Description

Use **Program 11-01 : System Numbering** to set the system numbering plan. The numbering plan assigns the first and second digits dialed and affects the digits an extension user must dial to access other extensions and features, such as service codes and trunk codes. If the default numbering plan does not meet the site requirements, use this program to tailor the system numbering to the site.

CAUTION!

Improperly programming this option can adversely affect system operation. Make sure you thoroughly understand the default numbering plan before proceeding. If you must change the standard numbering, use the chart for [Table 2-3 System Numbering Default Settings on page 2-79](#) to keep careful and accurate records of your changes.

Before changing your numbering plan, use PC Pro to make a backup copy of your system data.

Changing the numbering plan consists of three steps:

Step 1: Enter the digit(s) you want to change

You can make either single- or two-digit entries. In the Dialed Number column in the [Table 2-3 System Numbering Default Settings on page 2-79](#) table, the nX rows (e.g., 1X) are for single digit codes. The remaining rows (e.g., 11, 12, etc.) are for two digit codes.

- Entering a single digit affects all the Dialed Number entries beginning with that digit. For example, entering 6 affects all number plan entries beginning with 6. The entries you make in step 2 and step 3 below affect the entire range of numbers beginning with 6. (For example, if you enter 3 in step 2 the entries affected are 600~699. If you enter 4 in step 2 below, the entries affected are 6000~6999.)

- ❑ Entering two digits lets you define codes based on the first two digits a user dials. For example, entering 60 allows you to define the function of all codes beginning with 60. In the default program, only * and # use 2-digit codes. All the other codes are single digit. If you enter a two digit code between 0 and 9, be sure to make separate entries for all the other two digit codes within the range as well. This is because in the default program all the two digit codes between 0 and 9 are undefined.

 *Defining codes based on more than 2 digits require a secondary program (PRG 11-20) to define the codes.*

Step 2: Specify the length of the code you want to change

After you specify a single- or two-digit code, you must tell the system how many digits comprise the code. This is the **Number of Digits Required** column in the [Table 2-3 System Numbering Default Settings on page 2-79](#) table.

Step 3: Assign a function to the code selected

After entering a code and specifying its length, you must assign its function. This is the Dial Type column in the [Table 2-3 System Numbering Default Settings on page 2-79](#) table. The choices are:

Dial Types	Dial Type Description	Related Program
0	--- Not Used ---	
1	Service Code	11-10 : Service Code Setup (for System Administrator) 11-11 : Service Code Setup (for Setup/Entry Operation) 11-12 : Service Code Setup (for Service Access) 11-13 : Service Code Setup (for ACD) 11-14 : Service Code Setup (for Hotel) 11-15 : Service Code Setup, Administrative (for Special Access) 11-16 : Single Digit Service Code Setup
2	Extension Number	11-02 : Extension Numbering 11-04 : Virtual Extension Numbering 11-06 : ACI Extension Numbering 11-07 : Department Group Pilot Numbers 11-08 : ACI Group Pilot Number 11-17 : ACD Group Pilot Number
3	Trunk Access Code	11-09-01 : Trunk Access Code
4	Special Trunk Access	11-09-02 : Trunk Access Code
5	Operator Access	20-17 : Operator Extension
6	ARS/F-Route Access	44-xx

Dial Types	Dial Type Description	Related Program
9	Dial Extension Analyze	11-20 : Dial Extension Analyze Table

 Changing the Dial Type for a range of codes can have a dramatic affect on how your system operates. Assume, for example, the site is a hotel that has room numbers from 100-399. To make extension numbers correspond to room numbers, you should use Program 11-02 to reassign extension numbers on each floor from 100 to 399. (Other applications might also require you to change entries in Program 11-10 ~ 11-16.)

Default

See the following tables for default settings.

Table 2-3 System Numbering Default Settings

Dial Types: 1=Service Code, 2=Extension Number, 3=Trunk Access, 4=Special Trunk Access, 5=Operator Access, 6=Flexible Routing, 9 = Dial Extension Analyze, 0=Not Used				
Dialed	Number of Digits Required		Dial Type	
	Default	New	Default	New
1X	3		2	
11	0		0	
12	0		0	
13	0		0	
14	0		0	
15	0		0	
16	0		0	
17	0		0	
18	0		0	
19	0		0	
10	0		0	
1*	0		0	
1#	0		0	
2X	3		2	
21	0		0	
22	0		0	
23	0		0	
24	0		0	
25	0		0	
26	0		0	

Table 2-3 System Numbering Default Settings (Continued)

Dial Types: 1=Service Code, 2=Extension Number, 3=Trunk Access, 4=Special Trunk Access, 5=Operator Access, 6=Flexible Routing, 9 = Dial Extension Analyze, 0=Not Used

Dialed	Number of Digits Required		Dial Type	
	Default	New	Default	New
27	0		0	
28	0		0	
29	0		0	
20	0		0	
2*	0		0	
2#	0		0	
3X	4		2	
31	0		0	
32	0		0	
33	0		0	
34	0		0	
35	0		0	
36	0		0	
37	0		0	
38	0		0	
39	0		0	
30	0		0	
3*	0		0	
3#	0		0	
4X	3		1	
41	0		0	
42	0		0	
43	0		0	
44	0		0	
45	0		0	
46	0		0	
47	0		0	
48	0		0	
49	0		0	

Table 2-3 System Numbering Default Settings (Continued)

Dial Types: 1=Service Code, 2=Extension Number, 3=Trunk Access, 4=Special Trunk Access, 5=Operator Access, 6=Flexible Routing, 9 = Dial Extension Analyze, 0=Not Used

Dialed	Number of Digits Required		Dial Type	
	Default	New	Default	New
40	0		0	
4*	0		0	
4#	0		0	
5X	3		1	
51	0		0	
52	0		0	
53	0		0	
54	0		0	
55	0		0	
56	0		0	
57	0		0	
58	0		0	
59	0		0	
50	0		0	
5*	0		0	
5#	0		0	
6X	3		1	
61	0		0	
62	0		0	
63	0		0	
64	0		0	
65	0		0	
66	0		0	
67	0		0	
68	0		0	
69	0		0	
60	0		0	
6*	0		0	
6#	0		0	

Table 2-3 System Numbering Default Settings (Continued)

Dial Types: 1=Service Code, 2=Extension Number, 3=Trunk Access, 4=Special Trunk Access, 5=Operator Access, 6=Flexible Routing, 9 = Dial Extension Analyze, 0=Not Used

Dialed	Number of Digits Required		Dial Type	
	Default	New	Default	New
7X	3		1	
71	0		0	
72	0		0	
73	0		0	
74	0		0	
75	0		0	
76	0		0	
77	0		0	
78	0		0	
79	0		0	
70	0		0	
7*	0		0	
7#	0		0	
8X	1		1	
81	0		0	
82	0		0	
83	0		0	
84	0		0	
85	0		0	
86	0		0	
87	0		0	
88	0		0	
89	0		0	
80	0		0	
8*	0		0	
8#	0		0	
9X	1		3	
91	0		0	
92	0		0	

Table 2-3 System Numbering Default Settings (Continued)

Dial Types: 1=Service Code, 2=Extension Number, 3=Trunk Access, 4=Special Trunk Access, 5=Operator Access, 6=Flexible Routing, 9 = Dial Extension Analyze, 0=Not Used

Dialed	Number of Digits Required		Dial Type	
	Default	New	Default	New
93	0		0	
94	0		0	
95	0		0	
96	0		0	
97	0		0	
98	0		0	
99	0		0	
90	0		0	
9*	0		0	
9#	0		0	
0X	1		5	
01	0		0	
02	0		0	
03	0		0	
04	0		0	
05	0		0	
06	0		0	
07	0		0	
08	0		0	
09	0		0	
00	0		0	
0*	0		0	
0#	0		0	
*X	2		1	
*1	0		0	
*2	0		0	
*3	0		0	
*4	0		0	
*5	0		0	

Table 2-3 System Numbering Default Settings (Continued)

Dial Types: 1=Service Code, 2=Extension Number, 3=Trunk Access, 4=Special Trunk Access, 5=Operator Access, 6=Flexible Routing, 9 = Dial Extension Analyze, 0=Not Used

Dialed	Number of Digits Required		Dial Type	
	Default	New	Default	New
*6	0		0	
*7	0		0	
*8	0		0	
*9	0		0	
*0	0		0	
**	0		0	
*#	0		0	
#X	0		0	
#1	2		1	
#2	2		1	
#3	2		1	
#4	2		1	
#5	2		1	
#6	2		1	
#7	2		1	
#8	2		1	
#9	2		1	
#0	2		1	
**	4		1	
##	2		1	

Conditions

None

Feature Cross Reference

- Flexible System Numbering

Program 11 : System Numbering

11-02 : Extension Numbering

Level:
IN

Description

Use **Program 11-02 : Extension Numbering** to set the extension number. The extension number can have up to eight digits. The first/second digit(s) of the number should be assigned in Program 11-01 or Program 11-20. This allows an employee to move to a new location (port) and retain the same extension number.

Input Data

Extension Port Number	001 ~ 512
-----------------------	-----------

Item No.	Extension Number	Description
01	Dial (Up to 8 digits)	Set up extension numbers for multiline telephones, single line telephones (including SLTII Adapter, APR), and IP telephones. Extension number assignments cannot be duplicated in Programs 11-02, 11-06, 11-07, 11-08, and 11-17.

Default

Extension Port Number	Extension Number
1	101
2	102
3	103
?	?
99	199
100	3101
?	?
512	3513

Conditions

None

Feature Cross Reference

- Department Calling
- Flexible System Numbering
- Intercom

Program 11 : System Numbering

11-04 : Virtual Extension Numbering

Level:
IN

Description

Use **Program 11-04 : Virtual Extension Numbering** to define the virtual extension numbers. The extension number can have up to eight digits. The first/second digit(s) of the number should be assigned in Program 11-01 or Program 11-20.

Input Data

Virtual Extension Numbers	001~256
---------------------------	---------

Item No.	Virtual Extension Number	Description
01	Dial (up to 8 digits)	Set up Virtual Extension numbers. The extension number cannot be duplicated in Programs 11-02, 11-06, 11-07, 11-08, and 11-17.

Default

Virtual Port Number	Extension Number
1	201
2	202
3	203
∵	∵
99	299
100	3601
∵	∵
256	3857

Conditions

None

Feature Cross Reference

- Flexible System Numbering
- Multiple Directory Numbers / Call Coverage

Program 11 : System Numbering

11-06 : ACI Extension Numbering

Level:
IN

Description

Use **Program 11-06 : ACI Extension Numbering** to define the virtual extension number used for the ACI. The extension number can have up to eight digits. The first and second digits of the number should be assigned in Program 11-01 or Program 11-20.

Input Data

ACI Port Number	01~96
-----------------	-------

Item No.	ACI Extension Number	Description	Related Program
01	Dial (Up to 8 digits)	The extension number cannot be duplicated in Programs 11-02, 11-04, 11-07, 11-08, and 11-17.	10-03 : Basic Configuration for each blade.

Default

- ACI Port Numbers have no extension number set.

Conditions

None

Feature Cross Reference

- Analog Communications Interface (ACI)
- Flexible System Numbering

Program 11 : System Numbering

11-07 : Department Group Pilot Numbers

Level:
IN

Description

Use **Program 11-07 : Department Group Pilot Numbers** to assign a pilot number to each Department Group set up in Program 16-02. The pilot number is the number users dial for Department Calling and Department Step Calling. The pilot number can have up to eight digits. The first and second digits of the number should be assigned in Program 11-01 or Program 11-20 as type 2.

Input Data

Department (Extension) Group Number	01~64
-------------------------------------	-------

Item No.	Extension Group Pilot Number	Description	Related Program
01	Dial (Up to 8 digits)	Assign department group pilot numbers. The number set up by Program 11-02 (Extension Numbering) cannot be used. The extension number cannot be duplicated in Programs 11-02, 11-04, 11-06, 11-08, and 11-17.	<ul style="list-style-type: none"> <input type="radio"/> 16-01 : Department (Extension) Group Basic Data Setup <input type="radio"/> 16-02 : Department Group Assignment for Extensions <input type="radio"/> 16-03 : Secondary Department Group

Default

- No Setting

Conditions

None

Feature Cross Reference

- Department Calling
- Department Step Calling

Program 11 : System Numbering

11-08 : ACI Group Pilot Number

Level:
IN

Description

Use **Program 11-08 : ACI Group Pilot Number** to assign the pilot number to the ACI Groups set in Program 33-02. The pilot number can have up to four digits. The first and second digits of the number should be assigned in Program 11-01 or Program 11-20 as type 2.

Input Data

ACI Group Number		01~16	
Item No.	ACI Group Pilot Number	Description	Related Program
01	Dial (Up to 8 digits)	The extension number cannot be duplicated in Programs 11-02, 11-04, 11-06, 11-07, and 11-17.	33-02

Default

- No Setting

Conditions

None

Feature Cross Reference

- Analog Communications Interface (ACI)

Program 11 : System Numbering

11-09 : Trunk Access Code

Level:
IN

Description

Use **Program 11-09 : Trunk Access Code** to assign the trunk access code (normally 9). The trunk access code can be set from 1~8 digits which is defined to type 3 and 4 in Program 11-01. This is the code extension users dial to access Automatic Route Selection. The individual Trunk Access Code is used when Trunk Group Routing is desired for an outgoing line.

Caution!

The digit 9 is defined in Program 11-01 as Dial Type 3 with the Number of Digits Required set to 1. If you change the trunk access code in Program 11-09, you must make the corresponding changes in Program 11-01.

Input Data

Item No.	Trunk Access Code	Description	Default	Related Program
01	Dial (Up to four digits)	Assign the trunk access code (normally 9). This is the code extension users dial to access Automatic Route Selection.	9	<ul style="list-style-type: none"> <input type="radio"/> 11-01 : System Numbering <input type="radio"/> 14-01 : Basic Trunk Data Setup <input type="radio"/> 14-05 : Trunk Group <input type="radio"/> 14-06 : Trunk Group Routing <input type="radio"/> 21-02: Trunk Group Routing for Extensions

Input Data (Continued)

Item No.	Trunk Access Code	Description	Default	Related Program
02	2nd Trunk Route Access Code	Define additional trunk access codes. When a user dials the Alternate Trunk Route Access Code, the system routes their call to the Alternate Trunk Route.	No Setting	<ul style="list-style-type: none"> ○ 11-01 : System Numbering ○ 14-01 : Basic Trunk Data Setup ○ 14-05 : Trunk Group ○ 14-06 : Trunk Group Routing ○ 21-02 : Trunk Group Routing for Extensions ○ 21-15 : Individual Trunk Group Routing for Extensions

Conditions

None

Feature Cross Reference

- Automatic Route Selection
- Central Office Calls, Placing
- Trunk Group Routing

Program 11 : System Numbering

11-10 : Service Code Setup (for System Administrator)

Level:
IN

Description

Use **Program 11-10 : Service Code Setup (for System Administrator)** to customize the Service Codes for the System Administrator. You can customize additional Service Codes in Programs 11-11~11-16. The following chart shows:

- The number of each code (01~42).
- The function of the Service Code.
- The type of telephones that can use the Service Code.
- The default entry. For example, dialing Item 26 allows users to force a trunk line to disconnect.

Input Data

Item No.	Item	Terminals	Default	Related Program
01	Night Mode Switching	MLT, SLT	718	12-xx 20-07-01
02	--- Not Used ---			
03	Setting the System Time	MLT	728	
04	Storing Common Speed Dialing Numbers	MLT	753	
05	Storing Group Speed Dialing Numbers	MLT	754	
06	Setting the Automatic Transfer for Each Trunk Line	MLT	733	24-04-01
07	Canceling the Automatic Transfer for Each Trunk Line	MLT	734	24-04-01
08	Setting the Destination for Automatic Trunk Transfer	MLT	735	24-04-01
09	Charging Cost Display by the Supervisor	MLT	Not Set	
10	--- Not Used ---			
11	Entry Credit for Toll Restriction	MLT	Not Set	

Input Data

Item No.	Item	Terminals	Default	Related Program
12	Night Mode Switching for Other Group	MLT	618	12-xx 20-07-01
13	--- Not Used ---			
14	--- Not Used ---			
15	--- Not Used ---			
16	Leaving Message Waiting (Requires CPU to be licensed for Hotel/Motel)	MLT	626	11-11-09
17	Dial Block by Supervisor	MLT	601	90-19
18	Off-Premise Call Forward by Door Box	MLT	722	13-05
19	--- Not Used ---			
20	VRS - Record/Erase Message	MLT, SLT	616	20-07-13
21	VRS - General Message Playback	MLT, SLT	611	20-07-14
22	VRS - Record or Erase General Message	MLT, SLT	612	20-07-15
23	SMDR - Extension Accumulated Printout Code	MLT	621	20-07-18
24	SMDR - Group Accumulated Printout Code	MLT	622	20-07-19
25	Account Code Accumulated Printout Code	MLT	623	20-07-20
26	Forced Trunk Disconnect	MLT, SLT	Not Set	20-07-11
27	Trunk Port Disable for Outgoing Calls	MLT, SLT	645	20-07-12
28	--- Not Used ---			
29	--- Not Used ---			
30	--- Not Used ---			
31	--- Not Used ---			
32	Set Private Call Refuse	MLT, SLT	Not Set	
33	Entry Caller ID Refuse	MLT	Not Set	
34	Set Caller ID Refuse	MLT, SLT	Not Set	
35	Dial-In Mode Switching	MLT, SLT	Not Set	

Input Data

Item No.	Item	Terminals	Default	Related Program
36	Change the Guidance Message Number on Voice Mail Auto Attendant	MLT, SLT	Not Set	
41	Date Setting	MLT	Not Set	20-07-30
42	Maintenance Service	MLT	Not Set	

-  *MLT = Multiline Terminal*
-  *SLT = Single Line Telephone*

Conditions

None

Feature Cross Reference

- Refer to Input Data chart on the previous pages.

Program 11 : System Numbering

11-11 : Service Code Setup (for Setup/Entry Operation)

Level:
IN

Description

Use **Program 11-11 : Service Code Setup (for Setup/Entry Operation)** to customize the Service Codes which are used for registration and setup. You can customize additional Service Codes in Programs 11-10, and 11-12 ~ 11-16.

The following chart shows:

- The number of each code (01~65).
- The function of the Service Code.
- What type of telephones can use the Service Code.
- The default entry. For example, dialing 725 (Item 18) allows users to turn on or turn off Background Music.

Input Data

Item No.	Item	Terminals	Default	Related Program
01	Call Forward – All	MLT, SLT	741	
02	Call Forward – Busy	MLT, SLT	742	
03	Call Forward – No Answer	MLT, SLT	743	
04	Call Forward – Busy/No Answer	MLT, SLT	744	
05	Call Forward – Both Ring	MLT, SLT	745	
06	--- Not Used ---			
07	Call Forwarding – Follow-Me	MLT, SLT	746	
08	Do Not Disturb	MLT, SLT	747	
09	Answer Message Waiting	MLT, SLT	*0	11-10-16
10	Cancel All Messages Waiting	MLT, SLT	773	
11	Cancel Message Waiting	MLT, SLT	771	
12	Alarm Clock	MLT, SLT	727	20-01-06
13	Display Language Selection for Multiline Terminal	MLT	678	15-02

Input Data (Continued)

Item No.	Item	Terminals	Default	Related Program
14	Text Message Setting	MLT	No Setting	
15	Enable Handsfree Incoming Intercom Calls	MLT	721	20-09-05 20-02-12
16	Force Ringing of Incoming Intercom Calls	MLT	723	20-09-05 20-02-12
17	Programmable Function Key Programming (2-Digit Service Codes)	MLT	751	15-07 11-11-38
18	BGM On/Off	MLT	725	
19	Key Touch Tone On/Off	MLT	724	
20	Change Incoming CO and ICM Ring Tones	MLT	720	15-02
21	Check Incoming Ring Tones	MLT	711	
22	Extension Name Programming	MLT	700	15-01
23	Second Call for DID/DISA/DIL	MLT	679	
24	Change Station Class of Service Allow an extension user to change the COS of another extension. Must be allowed in Program 20-13-28.	MLT	677	20-13-28
25	Automatic Transfer Setup for Each Extension Group	MLT, SLT	602	20-11-17 24-05
26	Automatic Transfer Cancellation for Each Extension Group	MLT, SLT	603	
27	Destination of Automatic Transfer Each Extension Group	MLT	604	20-11-17 24-05
28	Delayed Transfer for Every Extension Group	MLT, SLT	605	20-11-17 24-05 24-02-08
29	Delayed Transfer Cancellation for Each Extension Group	MLT, SLT	606	20-11-17
30	DND Setup for Each Extension Group	MLT, SLT	607	
31	DND Cancellation for Each Extension Group	MLT, SLT	608	
32	--- Not Used ---			
33	Dial Block	MLT, SLT	600	
34	Temporary Toll Restriction Override	MLT, SLT	775	21-07
35	Pilot Group Withdrawing	MLT, SLT	650	
36	Toll Restriction Override	MLT, SLT	663	21-14

Input Data (Continued)

Item No.	Item	Terminals	Default	Related Program
37	Ring Volume Set	MLT	729	
38	Programmable Function Key Programming (3-Digit Service Codes)	MLT	752	15-07 11-11-17
39	Station Speed Dial Number Entry	MLT, SLT	755	
40	--- Not Used ---			
41	Tandem Ringing	MLT, SLT	No Setting	15-07 30-03
42	--- Not Used ---			
43	Headset Mode Switching	MLT, SLT	688	
44	Auto Attendant	MLT, SLT	No Setting	
45	Set/Cancel Call Forward All (Split)	MLT, SLT	No Setting	
46	Set/Cancel Call Forward Busy (Split)	MLT, SLT	No Setting	
47	Set/Cancel Call Forward No Answer (Split)	MLT, SLT	No Setting	
48	Set/Cancel Call Forward Busy No Answer (Split)	MLT, SLT	No Setting	
49	Set/Cancel Call Forward Both Ring (Split)	MLT, SLT	No Setting	
50	Set Message Waiting Indication	SLT	No Setting	15-03-03 45-01-01
51	Cancel Message Waiting Indication	SLT	No Setting	15-03-03 45-01-01
52	Set/Cancel Call Forward All Destination (No Split)	MLT, SLT	790	
53	Set/Cancel Call Forward Busy Destination (No Split)	MLT, SLT	791	
54	Set/Cancel Call Forward No Answer Destination (No Split)	MLT, SLT	792	
55	Call Forward Busy No Answer Destination (No Split)	MLT, SLT	793	
56	Telephone Book Lock Service	MLT	No Setting	
57	Set Do Not Call Table	MLT, SLT	No Setting	

Input Data (Continued)

Item No.	Item	Terminals	Default	Related Program
58	Call Forward with Personal Greeting	MLT, SLT	713	
59	Call Forward to Attendant except Busy	MLT, SLT	No Setting	15-01-08
60	Call Forward to Attendant/No Answer	MLT, SLT	No Setting	15-01-09
62	Headset Ring Volume Adjustment	MLT	662	11-11-37 15-02-12 15-02-41 15-02-42
63	Double Height Character Indication	MLT	No Setting	15-02-45
64	Reverse Display Indication	MLT	No Setting	15-02-44
65	Headset Mode Switching	MLT	No Setting	

 *MLT = Multiline Terminal*
 *SLT = Single Line Telephone*

Conditions

None

Feature Cross Reference

- Refer to the Input Data chart above.

Program 11 : System Numbering

11-12 : Service Code Setup (for Service Access)

Level:
IN

Description

Use **Program 11-12 : Service Code Setup (for Service Access)** to customize the Service Codes which are used for service access. You can customize additional Service Codes in Programs 11-10, 11-11, and 11-13 through 11-16.

The following chart shows:

- The number of each code (01~59).
- The function of the Service Code.
- The type of telephones that can use the Service Code.
- The default entry. For example, dialing 770 (Item 05) cancels a previously set Camp-On.
- Programs that may be affected with the changing the code.

Input Data

Item No.	Item	Terminals	Default	Related Program
01	Bypass Call Activate Call Forwarding/Do Not Disturb Override. This code is available only if you disable the voice mail Single Digit dialing code in Program 11-16-09.	MLT, SLT	707	11-16-09
02	Conference	MLT, SLT	#1	
03	Override (Off-Hook Signaling)	MLT, SLT	709	
04	Set Camp-On	MLT, SLT	750	
05	Cancel Camp-On	MLT, SLT	770	
06	Switching of Voice Call and Signal Call	MLT, SLT	712	
07	Step Call	MLT, SLT	708	
08	Barge-In	MLT, SLT	710	
09	Change to STG (Department Group) All Ring	MLT, SLT	No Setting	16-02
10	Station Speed Dialing	MLT, SLT	#2	

Input Data (Continued)



Item No.	Item	Terminals	Default	Related Program
11	Group Speed Dialing	MLT, SLT	#4	
12	Last Number Dial	MLT, SLT	#5	
13	Saved Number Dial	MLT, SLT	715	
14	Trunk Group Access	MLT, SLT	704	
15	Specified Trunk Access	MLT, SLT	#9	
16	Trunk Access Via Networking	MLT, SLT	No Setting	
17	Clear Last Number Dialing Data	MLT, SLT	776	
18	Clear Saved Number Dialing Data	MLT, SLT	785	
19	Internal Group Paging	MLT, SLT	701	31-01-01
20	External Paging	MLT, SLT	703	
21	Meet-Me Answer to Specified Internal Paging Group	MLT, SLT	764	31-02-01
22	Meet-Me Answer to External Paging	MLT, SLT	765	
23	Meet-Me Answer in Same Paging Group	MLT, SLT	763	31-02-01
24	Combined Paging	MLT, SLT	*1	31-02-01 31-07
25	Direct Call Pickup - Own Group	MLT, SLT	756	
26	Call Pickup for Specified Group	MLT, SLT	768	23-02
27	Call Pickup	MLT, SLT	* #	23-02
28	Call Pickup for Another Group	MLT, SLT	769	23-02
29	Direct Extension Call Pickup	MLT, SLT	**	
30	Specified Trunk Answer	MLT, SLT	672	
31	Park Hold	MLT, SLT	#6	24-03
32	Answer for Park Hold	MLT, SLT	*6	24-03
33	Group Hold	MLT, SLT	732	
34	Answer for Group Hold	MLT, SLT	762	
35	Station Park Hold	MLT, SLT	757	
36	Door Box Access	MLT, SLT	702	
37	Common Canceling Service Code	MLT, SLT	620	

Input Data (Continued)

Item No.	Item	Terminals	Default	Related Program
38	General Purpose Indication	MLT	783	15-07-56 15-07-57
39	--- Not Used ---			
40	Station Speed Dialing	MLT, SLT	#7	
41	Voice Over	MLT	690	11-16-08
42	Flash on Trunk lines	SLT	#3	
43	Answer No-Ring Line (Universal Answer)	MLT, SLT	#0	14-05 14-06
44	Callback Test for SLT	SLT	799	
45	Enabled On Hook When Holding (SLT)	SLT	749	15-03-07
46	Answer On Hook When Holding (SLT)	SLT	759	15-03-08
47	Call Waiting Answer/Split Answer Splitting (switching) between calls	SLT	794	11-12-03
48	Account Code	SLT	# #	
49	--- Not Used ---			
50	General Purpose Relay	MLT, SLT	780	
51	VM Access (SV8100 InMail and VMS)	MLT, SLT	*8	
52	Live Monitoring (SV8100 InMail)	MLT	No Setting	
53	Live Recording at SLT	MLT, SLT	654	
54	VRS Routing for ANI/DNIS Use when setting up ANI/DNIS Routing to the VRS Automated Attendant. Using the Transfer feature, this also allows a call to be transferred to the VRS.	MLT, SLT	782	
55	--- Not Used ---			
56	E911 Alarm Shut Off Enter the Service Code that an extension user can dial to shut off the E911 Alarm Ring.	MLT	786	21-01-13 21-01-14
57	Tandem Trunking	MLT, SLT	#8	
58	Transfer Into Conference Assign the Service Code a user dials to Transfer a call to a Conference call.	MLT, SLT	624	20-13-10 20-13-15 20-13-16

Input Data (Continued)

Item No.	Item	Terminals	Default	Related Program
59	Trunk Drop Operation for SLT	SLT	No Setting	

-  *MLT = Multiline Terminal*
-  *SLT = Single Line Telephone*

Conditions

None

Feature Cross Reference

- Refer to the Input Data chart on the previous pages.

Program 11 : System Numbering

11-13 : Service Code Setup (for ACD)

Level:
IN

Description

Use **Program 11-13 : Service Code Setup (for ACD)** to customize the Service Codes which are used with the Automatic Call Distribution (ACD) feature. You can customize additional Service Codes in Programs 11-10 ~ 11-12 and 11-14 ~ 11-16. The following chart shows:

- The number of each code (01~13).
- The function of the Service Code.
- The type of telephones that can use the Service Code.
- The default entry.

Input Data

Item No.	Item	Terminals	Default
01	ACD Log In/Log Out (for KTS)	MLT, SLT	*5
02	ACD Log Out (for SLT)	SLT	655
03	Set ACD Wrap-Up Time (for SLT)	SLT	656
04	Cancel ACD Wrap-Up Time (for SLT)	SLT	657
05	Set ACD Off Duty (for SLT)	SLT	658
06	Cancel ACD Off Duty (for SLT)	SLT	659
07	--- Not Used ---		
08	Agent ID Code Login Allow an AIC Agent to log into a group.	MLT	No Setting
09	Agent ID Code Logout Allow an AIC Agent to log out of a group.	MLT	No Setting
10	ACD Agent Login by Supervisor Allow an ACD Supervisor to log into a group.	MLT	667
11	ACD Agent Logout by Supervisor Allow an ACD Supervisor to log out of a group.	MLT	668

Input Data

Item No.	Item	Terminals	Default
12	Change Agent ACD Group by Supervisor When using service code 669 to change an agent ACD group, the supervisor must enter a 2-digit number for the group. For example, to change to ACD group 4, the entry would be 669 04.	MLT	669
13	ACD Agent Changing Own ACD Group Using this service code, an ACD Agent can reassign themselves to another ACD Group.	MLT	670

 *MLT = Multiline Terminal*

 *SLT = Single Line Telephone*

Conditions

None

Feature Cross Reference

- Automatic Call Distribution (ACD)

Program 11 : System Numbering

11-14 : Service Code Setup (for Hotel)

Level:
IN

Description

Use **Program 11-14 : Service Code Setup (for Hotel)** to customize the Service Codes which are used with the Hotel/Motel feature. You can customize additional Service Codes in Programs 11-10 ~ 11-13, 11-15 and 11-16. The Service Codes can be used only at telephones registered as hotel terminals in Program 42-02.

The following chart shows:

- The number of each code (01~18).
- The function of the Service Code.
- The type of telephones that can use the Service Code.
- The default entry.

Input Data

Item No.	Item	Terminals	Default
01	Set DND for Own Extension	MLT, SLT	627
02	Cancel DND for Own Extension	MLT, SLT	628
03	Set DND for Other Extension	MLT, SLT	629
04	Cancel DND for Other Extension	MLT, SLT	630
05	Set Wake Up Call for Own Extension	MLT, SLT	631
06	Cancel Wake Up Call for Own Extension	MLT, SLT	632
07	Set Wake Up Call for Other Extension	MLT, SLT	633
08	Cancel Wake Up Call for Other Extension	MLT, SLT	634
09	Set Room to Room Call Restriction	MLT, SLT	635
10	Cancel Room to Room Call Restriction (Hotel)	MLT, SLT	636
11	Change Toll Restriction Class for Other Extension	MLT, SLT	637
12	Check-In	MLT, SLT	638
13	Check-Out	MLT, SLT	639

Input Data

Item No.	Item	Terminals	Default
14	Room Status Change for Own Extension	MLT, SLT	640
15	Room Status Change for Other Extension	MLT, SLT	641
16	Room Status Output	MLT	642
17	Hotel Room Monitor	MLT, SLT	675
18	Set Hotel PMS Code Restriction	MLT	666

 *MLT = Multiline Terminal*

 *SLT = Single Line Telephone*

Conditions

None

Feature Cross Reference

Hotel/Motel

Program 11 : System Numbering

11-15 : Service Code Setup, Administrative (for Special Access)

Level:
IN

Description

Use **Program 11-15 : Service Code Setup, Administrative (for Special Access)** to customize the special access Service Codes which are used by the administrator in the Hotel/Motel feature. You can customize additional Service Codes in Programs 11-10 ~ 11-14 and 11-16.

The following chart shows:

- The number of each code (01~14).
- The function of the Service Code.
- What type of telephones can use the Service Code.
- The default entry.
- Programs that may be affected when changing the code.

Input Data

Item No.	Item	Terminals	Default	Related Program
01	Remote Maintenance		730	
02	ACD Access in Dial-In Conversion Table		760	22-04 22-11
03	Backup Data Save Save the user's soft key settings (extension programmed Call Forwards, DND, etc.). This feature should be used before upgrading the system software.	MLT	# * # 9	
04	--- Not Used ---			
05	System Programming Mode, Log-On	MLT	# * # *	11-01
06	Wake on LAN to APSU Unit	MLT	No Setting	10-22
07	--- Not Used ---			
08	Network Message Lamp Control		766	

Input Data

Item No.	Item	Terminals	Default	Related Program
09	Transfer to Incoming Ring Group		No Setting	
10	--- Not Used ---			
11	Ethernet Port Reset			
12	Extension Data Swap	MLT		92-04
13	Remote Access from DISA		No Setting	22-02
14	Modem Access		740	

 *MLT = Multiline Terminal*

 *SLT = Single Line Telephone*

Conditions

None

Feature Cross Reference

- Hotel/Motel

Program 11 : System Numbering

11-16 : Single Digit Service Code Setup

Level:
IN

Description

Use **Program 11-16 : Single Digit Service Code Setup** to customize the one-digit Service Codes used when a busy or ring back signal is heard. You can customize additional Service Codes in Programs 11-10 ~ 11-15.

The following chart shows:

- The number of each code (01~11).
- The function of the Service Code.
- The default entry. For example, dialing 1 (code 03) when calling an extension switches the call from either a voice or signal call (depending on how it is currently defined).
- Programs that may be affected by changing these codes.

Input Data

Item No.	Item	Default	Related Program
01	Step Call	2	11-12-07
02	Barge-In	No Setting	11-12-08
03	Switching of Voice/Signal Call	1	11-12-06
04	Intercom Off-Hook Signaling	*	11-12-03
05	Camp-On	#	11-12-04
06	DND/Call Forward Override Bypass	No Setting	11-12-01
07	Message Waiting	0	11-12-09
08	Voice Over	6	11-12-41
09	Access to Voice Mail	8	11-12-51
10	(Department) STG All Ring Mode	No Setting	11-12-09 16-01-05
11	Station Park Hold	No Setting	11-12-35

Conditions

None

Feature Cross Reference

- Refer to the Input Data chart on previous pages.

Program 11 : System Numbering

11-17 : ACD Group Pilot Number

Level:
IN

Description

Use **Program 11-17 : ACD Group Pilot Number** to assign the ACD Master Number for each ACD Group. This is the number a user dials to transfer calls to the ACD Group. Normally, you should use unassigned extension numbers (e.g., 500) for the master number. If you want to use an extension number which, by default, has a port number assigned (for example: in the 101~199, 3101~3257), first remove the default assignment. For example, to use extension number 125 as an ACD Master Number, first give extension port 025 a different extension assignment.

Input Data

ACD Group Number	01~64
------------------	-------

Item No.	ACD Group Pilot Number
01	Dial (Up to eight digits)

Default

- No ACD Group Pilot Number assigned to any ACD Group (1~64).

Conditions

None

Feature Cross Reference

- Automatic Call Distribution (ACD)
- Multiple Directory Numbers/Call Coverage Keys

Program 11 : System Numbering

11-20 : Dial Extension Analyze Table

Level:
IN

Description

Use **Program 11-20 : Dial Extension Analyze Table** to define the dial type based on three or more digits. This program is relevant only if digits in 11-01-01 are set to 9 (Dial Extension Analyze).

Input Data

Dial Extension Analyze Table	01~128
------------------------------	--------

Item No.	Dial Extension Analyze Table
01	Dial (Up to eight digits: 0, 1~9, #, *, @)
02	Type of Dials: 0 = Not used 1 = Service Code 2 = Extension Number 5 = Operator Access 6 = F-Route Access

Default

- Dial Extension Analyze Tables are not set at default.

Conditions

- When the system uses the Dial Extension Analyze Table to determine the dial type, the lower table has priority. For example, if Table 1 has 211 defined and Table 2 has 2113 defined, Table 1 is used to determine the dial type.

Feature Cross Reference

None

Program 12 : Night Mode Setup

12-01 : Night Mode Function Setup

Level:
IN

Program

12

Description

Use **Program 12-01 : Night Mode Function Setup** to set up the Night Mode options. Refer to the following chart for a description of each option, its range and default setting.

Input Data

Item No.	Item	Input Data	Default	Description	Related Program
01	Manual Night Mode Switching	0 = Off 1 = On	1	Allow/Prevent activating Night Service by dialing a service code.	11-10-01
02	Automatic Night Mode Switching	0 = Off 1 = On	0	According to a preset schedule, enable or disable Automatic Night Service for the system.	12-02 12-03 12-04

 Even if the operation mode is changed manually, the operation mode changes according to the schedule set up.

Conditions

None

Feature Cross Reference

- Night Service

Program 12 : Night Mode Setup

12-02 : Automatic Night Service Patterns

Level:
SA

Description

Use **Program 12-02 : Automatic Night Service Patterns** to define the daily pattern of the Automatic Mode Switching. Each Mode Group has 10 patterns. These patterns are used in Programs 12-03 and 12-04. The daily pattern consists of 20 timer settings.

Input Data

Night Mode Service Group Number	01~32
Time Pattern Number	01~10
Set Time Number	01~20

Item	Description	Input Data
01	Start Time	0000~2359
02	End Time	0000~2359
03	Operation Mode	1~8

Example:

Time Pattern 1

0:00	9:00	12:00	13:00	17:00	18:00	22:00	0:00
Mode 3 (midnight)	Mode 1 (day)	Mode 4 (rest)	Mode 1 (day)	Mode 4 (rest)	Mode 2 (night)	Mode 3 (midnight)	

To make the above schedule, it is necessary to set the data as follows:

Time setting 01:	00:00 to 09:00	Mode 3 (midnight)
Time setting 02:	09:00 to 12:00	Mode 1 (day)
Time setting 03:	12:00 to 13:00	Mode 4 (rest)
Time setting 04:	13:00 to 17:00	Mode 1 (day)
Time setting 05:	17:00 to 18:00	Mode 4 (rest)
Time setting 06:	18:00 to 22:00	Mode 2 (night)
Time setting 07:	22:00 to 00:00	Mode 3 (midnight)

Time Pattern 2

0:00 0:00

Mode 2
(night)

Time setting 01: 00:00 to 00:00 Mode 2 (night)

Default

All groups, all patterns : 00:00 to 00:00 = Mode 1

Time Pattern 1

Set Time Number	Start Time	End Time	Mode
01	0000	0800	2
02	0800	1700	1
03	1700	0000	2
04	0000	0000	1
:	:	:	:
20	0000	0000	1

Time Pattern 2

Set Time Number	Start Time	End Time	Mode
01	0000	0000	2
02	0000	0000	1
:	:	:	:
20	0000	0000	1

Time Pattern 3~10

Set Time Number	Start Time	End Time	Mode
01	0000	0000	1
:	:	:	:
20	0000	0000	1

Conditions

None

Feature Cross Reference

- Night Service

Program 12 : Night Mode Setup

12-03 : Weekly Night Service Switching

Level:
SA

Description

Use **Program 12-03 : Weekly Night Service Switching** to define a weekly schedule of night-switch settings.

Input Data

Night Mode Service Group Number	01~32
---------------------------------	-------

Item No.	Day of the Week	Time Schedule Pattern Number
01	01 = Sunday	0~10
	02 = Monday	
	03 = Tuesday	
	04 = Wednesday	
	05 = Thursday	
	06 = Friday	
	07 = Saturday	

Default

Day of the Week	Time Schedule Pattern Number
01 = Sunday	2
02 = Monday	1
03 = Tuesday	1
04 = Wednesday	1
05 = Thursday	1
06 = Friday	1
07 = Saturday	2

Conditions

None

Feature Cross Reference

- Night Service

Program 12 : Night Mode Setup

12-04 : Holiday Night Service Switching

Level:
SA

Description

Use **Program 12-04 : Holiday Night Service Switching** to define a yearly schedule of holiday night-switch settings. This schedule is used for the setting of special days when the company is expected to be closed, such as a national holiday.

Input Data

Night Mode Service Group Number	01~32
---------------------------------	-------

Item No.	Days and Months	Time Pattern Number
01	0101~1231 (e.g. 0101 = Jan. 1; 1231 = Dec. 31)	0~10 (0 = No Setting)

Default

- No setting

Conditions

None

Feature Cross Reference

- Night Service

Program 12 : Night Mode Setup

12-05 : Night Mode Group Assignment for Extensions

Level:

IN

Description

Use **Program 12-05 : Night Mode Group Assignment for Extensions** to assign a Day/Night Mode Group for each extension.

Input Data

Extension Number	Up to eight digits
------------------	--------------------

Item No.	Night Mode Service Group Number	Default
01	01~32	1

Conditions

None

Feature Cross Reference

- Night Service

Program 12 : Night Mode Setup

12-06 : Night Mode Group Assignment for Trunks

Level:
IN

Description

Use **Program 12-06 : Night Mode Group Assignment for Trunks** to assign a Day/ Night Mode Group for each trunk port.

Input Data

Trunk Port Number	001~200
-------------------	---------

Item No.	Night Mode Service Group Number	Default
01	01~32	1

Conditions

None

Feature Cross Reference

- Night Service

Program 12 : Night Mode Setup

12-07 : Text Data for Night Mode

Level:
IN

Description

Use **Program 12-07 : Text Data for Night Mode** to make an original text message which is displayed on an LCD of multiline telephone in each Mode.

Input Data

Night Mode Service Group Number	01~32
Day/Night Mode	1~8

Item No.	Text Message
01	Maximum 12 Characters (alphabetic or numeric)

Default

- Mode 1 = No setting
- Mode 2 = <Night>
- Mode 3 = <Midnight>
- Mode 4 = <Rest>
- Mode 5 = <Day2>
- Mode 6 = <Night2>
- Mode 7 = <Midnight2>
- Mode 8 = <Rest2>

Conditions

None

Feature Cross Reference

- Night Service

Program 12 : Night Mode Setup

12-08 : Night Mode Service Range

Level:
IN

Description

Use **Program 12-08 : Night Mode Service Range** to define the changing range of toggle key for each Day/Night Mode.

Input Data

Night Mode Service Group Number	01~32
---------------------------------	-------

Item No.	Range
01	2~8 (default = 2)

Example:

When Program 12-08 is set to 3 and the Mode Key is pressed (SC 751, 09 +0), the following modes are switched:

- Press once = Night
- Press twice = Mid-night
- Press third = Day
- Default = 2

Conditions

None

Feature Cross Reference

- Night Service

Program 13 : Abbreviated Dialing

13-01 : Speed Dialing Function Setup

Level:
SA

Program

13

Description

Use Program 13-01 : Speed Dialing Function Setup to define the Speed Dialing functions.

Input Data

Item No.	Item	Input Data	Default	Related Program
01	Speed Dialing Auto Outgoing Call Mode Set whether the Speed Dial bins use Trunk Routing (0) or dial the bin as though it is an Intercom number (1).	0 = Trunk Outgoing Mode 1 = Intercom Outgoing Mode	0	13-05
02	--- Not Used ---			
03	Number of Common Speed Dialing Bins Assign the number of Speed Dial bins that are used for System Speed Dials.	0~2000 0 = No Common Speed Dialing	1000	13-04

Conditions

None

Feature Cross Reference

- Speed Dial – System/Group/Station

Program 13 : Abbreviated Dialing

13-02 : Group Speed Dialing Bins

Level:
IN

Description

Use **Program 13-02 : Group Speed Dialing Bins** to define the range of bin numbers to be used by each Speed Dialing group. (Refer to [13-03 : Speed Dialing Group Assignment for Extensions](#)).

Input Data

Item No.	Speed Dialing Group Number	Start Address of Speed Dialing Bin	End Address of Speed Dialing Bin
01	01~64	0~1990	0, 9~1999

Default

No Setting

Conditions

None

Feature Cross Reference

Speed Dial - System/Group/Station

Program 13 : Abbreviated Dialing

13-03 : Speed Dialing Group Assignment for Extensions

Level:
IN

Description

Use **Program 13-03 : Speed Dialing Group Assignment for Extensions** to assign Speed Dialing Group for each extension. There are 64 available Speed Dialing groups.

Input Data

Extension Number	Maximum of eight digits
------------------	-------------------------

Item No.	Group Number	Default Value
01	01~64	1

Conditions

None

Feature Cross Reference

- Speed Dial - System/Group/Station

Program 13 : Abbreviated Dialing

13-04 : Speed Dialing Number and Name

Level:
SB

Description

Use **Program 13-04 : Speed Dialing Number and Name** to store Speed Dialing data in the Speed Dialing areas. This program is also used to define the names assigned to the Speed Dialing numbers.

Input Data

Speed Dialing Bin Number	0~1999
--------------------------	--------

Item No.	Item	Input Data	Default	Related Program
01	Speed Dialing Data	1~9, 0, *, #, Pause (Press line key 1), Recall/Flash (Press line key 2), @ = Code to wait for answer supervision in ISDN (Press line key 3) (max. 24 digits)	No Setting	
02	Name	Maximum 12 Characters (Use dial pad to enter name)	No Setting	
03	Transfer Mode	0 = Not Used 1 = Internal Dial 2 = Incoming Ring Group (IRG)	0	
04	Transfer Destination Number	If Transfer mode is (Refer to 13-04-03): 1 = Internal Dial Mode 1~9, 0, *, #, P, R, @ (Maximum 24 Characters) 2 = Incoming Ring Group 0 ~ 100 (IRG Number) P = Pause R = Recall @ = Additional Digits when using ISDN functionality	No Setting	13-04-03

Item No.	Item	Input Data	Default	Related Program
05	Incoming Ring Pattern	Incoming Ring Pattern 0 = Normal Pattern 1 ~ 4 = Tone Pattern (1~4) 5 ~ 9 = Scale Pattern (1~5)	0	13-04-03

Conditions

None

Feature Cross Reference

- Speed Dial – System/Group/Station

Program 13 : Abbreviated Dialing

13-05 : Speed Dial Trunk Group

Level:
SB

Description

Use **Program 13-05 : Speed Dialing Trunk Group** to define the trunk group to be seized for each Speed Dialing number.

If this program has an entry of 0 (no setting), then seizing a line follows the trunk access group routing of the caller's extension (refer to Program 14-06). This setting is available only in External Speed Dialing Mode (Program 13-01-01).

Input Data

Speed Dialing Bin Number	0~1999
--------------------------	--------

Item No.	Trunk Group Number
01	0~100

Default

No Setting

Conditions

None

Feature Cross Reference

Speed Dial – System/Group/Station

Program 13 : Abbreviated Dialing

13-07 : Telephone Book Dial Number and Name

Level:
SB

Description

Use **Program 13-07 : Telephone Book Dial Number and Name** to set up the dial number and name of each Telephone Book Number.

Input Data

Telephone Book Number	0~100
-----------------------	-------

Item No.	Item	Input Data	Default	Related Program
01	Speed Dialing Data	1~9, 0, *, #, Pause (Press line key 1), Recall/Flash (Press line key 2), @ = Code to wait for answer supervision in ISDN (Press line key 3) (max. 24 digits)	No Setting	
02	Name	Maximum 12 Characters (Use dial pad to enter name)	No Setting	
04	Group Number	1~20	1	

Conditions

None

Feature Cross Reference

None

Program 13 : Abbreviated Dialing

13-08 : Telephone Book System Name

Level:
SB

Description

Use **Program 13-08 : Telephone Book System Name** to set up the name of the Telephone Book.

Input Data

Telephone Book Number	0~100
-----------------------	-------

Item No.	Item	Input Data	Default	Related Program
01	Telephone Book Name	Up to six characters	No Setting	

Conditions

None

Feature Cross Reference

None

Program 13 : Abbreviated Dialing

13-09 : Telephone Book Group Name

Level:
SB

Description

Use **Program 13-09 : Telephone Book Group Name** to set up the group name of the Telephone Book.

Input Data

Telephone Book Number	0~100
-----------------------	-------

Item No.	Group Number
01	0~20

Item No.	Item	Input Data	Default	Related Program
01	Group Name	Up to 12 characters	1 = Group 01 2 = Group 02 3 = Group 03 ⋮ 20 = Group 20	

Conditions

None

Feature Cross Reference

None

Program 13 : Abbreviated Dialing

13-10 : Telephone Book Routing

Level:
SB

Description

Use **Program 13-10 : Telephone Book Routing** to set up outgoing mode when using the Telephone Book. Trunk outgoing mode follows Program 14-06 setting.

Input Data

Telephone Book Number	0~100
-----------------------	-------

Item No.	Item	Input Data	Default	Related Program
01	Outgoing Mode	0 = Trunk Outgoing 1 = Intercom Outgoing	0	

Conditions

None

Feature Cross Reference

None

Program 14 : Trunk, Basic Setup

14-01 : Basic Trunk Data Setup

Level:
IN

Program

14

Description

Use **Program 14-01 : Basic Trunk Data Setup** to set the basic options for each trunk port. Refer to the table below for a description of each option, its range and default setting.

Input Data

Trunk Port Number	001~200
-------------------	---------

Item No.	Item	Input Data	Default	Related Program
01	Trunk Name Set the names for trunks. The trunk name displays on a multiline terminal for incoming and outgoing calls.	Up to 12 Characters	Line 001 Line 002 Line 003 : Line 200	
02	Transmit Level Select the CODEC gain for the trunk. The option sets the gain (signal amplification) for the trunk you are programming.	1~63 (-15.5dB~ +15.5dB in 0.5dB intervals)	32 (0dB)	
03	Receive Level Select the CODEC gain for the trunk. The option sets the gain (signal amplification) for the trunk you are programming.	1~63 (-15.5dB ~ +15.5dB in 0.5dB intervals)	32 (0dB)	

Item No.	Item	Input Data	Default	Related Program
04	Transmit Gain Level for Conference and Transfer Calls Select the CODEC gain type used by the trunk when it is part of an Unsupervised Conference.	1~63 (-15.5dB ~ +15.5dB in 0.5dB intervals)	32 (0dB)	
05	Receive Gain Level for Conference and Transfer Calls Select the CODEC gain type used by the trunk when it is part of an Unsupervised Conference.	1~63 (-15.5dB ~ +15.5dB in 0.5dB intervals)	16 (-8dB)	
06	SMDR Printout Include/Exclude the trunk you are programming from the SMDR printout. Refer to Program 35-01 and 35-02 for SMDR printout options.	0 = No Print Out 1 = Prints Out	0	35-01 35-02
07	Outgoing Calls Allow/Prevent outgoing calls on the trunk you are programming.	0 = Deny (No) 1 = Allow (Yes)	1	
08	Toll Restriction Enable/Disable Toll Restriction for the trunk. If enabled, the trunk follows Toll Restriction programming (example: Programs 21-05, 21-06). If disabled, the trunk is a toll free line.	0 = Restriction Disabled (No) 1 = Restriction Enabled (Yes)	1	21-04 21-05 21-06
09	Private Line	0 = Disable Private Line (Normal) 1 = Enable Private Line (Private Line)	0	

Item No.	Item	Input Data	Default	Related Program
10	DTMF Tones for Outgoing Calls Enable/ Disable DTMF tones for outgoing trunk calls.	0 = Disable (No) 1 = Enable (Yes)	0	
11	Account Code Required	0 = Disable (No) 1 = Enable (Yes)	1	
12	--- Not Used ---			
13	Trunk-to-Trunk Transfer Enable/Disable loop supervision for the trunk. This option is required for Call Forwarding Off-Premise and Tandem Trunking only.	0 = Disable (No) 1 = Enable (Yes)	1	
14	Long Conversation Cutoff Enable/Disable the Long Conversation Cutoff feature for each trunk.	0 = Disable (No) 1 = Enable (Yes)	0	20-21-03 20-21-04
15	Long Conversation Alarm Before Cutoff Enable/Disable the Long Conversation Alarm for each trunk.	0 = Disable (No) 1 = Enable (Yes)	0	20-21-01 20-21-02
16	Forced Release of Held Call Enable/Disable forced release for calls on Hold. If enabled, the system disconnects a call if it is on Hold longer than a programmed interval (Program 24-01-05). If disabled, forced disconnection does not occur. Program 24-01-01 also affects this option.	0 = Disable (No) 1 = Enable (Yes)	0	24-01-01 24-01-05

Item No.	Item	Input Data	Default	Related Program
17	<p>Trunk to Trunk Warning Tone for Long Conversation Alarm</p> <p>Enable/Disable the Warning Tone for Long Conversation feature for DISA callers.</p>	0 = Disable (No) 1 = Enable (Yes)	0	
18	<p>Warning Beep Tone Signaling</p>	0 = Disable (No) 1 = Enable (Yes)	0	
19	<p>Privacy Mode Toggle Option</p> <p>Enable/Disable a trunk ability to be switched from private to non-private mode by pressing the line key or Privacy Release function key.</p>	0 = Disable (No) 1 = Enable (Yes)	0	
20	<p>Block Outgoing Caller ID</p> <p>Allow (1)/Prevent (0) the system from automatically blocking outgoing Caller ID information when a user places a call. If allowed (i.e. block, enabled), the system automatically inserts the Caller ID block code (defined in 14-01-21) before the user dialed digits.</p>	0 = Disable (No) 1 = Enable (Yes)	0	14-01-21
21	<p>Caller ID Block Code</p> <p>Enter the code, up to 8 digits, that should be used as the Caller ID Block Code. This code is automatically inserted before dialed digits if Program 14-01-20 is set to 1.</p>	Dial (up to eight digits)	*67	14-01-20

Item No.	Item	Input Data	Default	Related Program
22	Caller ID to Voice Mail Enable/ Disable the system ability to send the Caller ID digits (Remote Log-On Protocol) to voice mail.	0 = Disable (No) 1 = Enable (Yes)	0	
23	--- Not Used ---			
24	Trunk-to-Trunk Outgoing Caller ID through Mode Enable/Disable the ability to send the original Caller ID through when the call is Forward Off-Premise.	0 = Disable (No) 1 = Enable (Yes)	0	
25	Continued/ Discontinued Trunk-to-Trunk Conversation Enable/Disable the ability to dial a service code to continue or disconnect the Trunk-to-Trunk conversation after the alert tone is heard.	0 = Disable (No) 1 = Enable (Yes)	0	20-28-01 20-28-02 20-28-03 24-02-07 24-02-10 25-07-07 25-07-08
26	Automatic Trunk-to-Trunk Transfer Mode	0 = Normal Transfer (Normal) 1 = Step Transfer (Step)	0	24-02-11 24-02-12
27	Caller ID Refuse Setup	0 = Disable (No) 1 = Enable (Yes)	0	
28	Effectivity of Conversation Recording Destination for Extension	0 = No Effect (No) 1 = Available (Yes)	1	15-12
30	Flexible Ringing by Caller ID	0 = Disable (No) 1 = Enable (Yes)	1	13-04
32	Anti-trombone Function	0 = No Effect (No) 1 = Available (Yes)	0	

Item No.	Item	Input Data	Default	Related Program
33	APSU Trunk Receive Gain Additional PAD when a trunk call connects to APSU Voice Mail.	1~63 (-15.5dB ~ +15.5dB in 0.5dB intervals)	32 (0dB)	
35	DT700 Large LED Illumination Setup Sets LED color for incoming trunk call. In DT700 local terminal setting menu, illumination setting must be 'Automatic', otherwise the terminal will ignore PRG 14-01-35, PRG 15-05-37 and PRG 15-23 settings.	2 = Red 3 = Green 4 = Blue 5 = Yellow 6 = Purple 7 = Light Blue 8 = White 9 = Rotation	2	
36	Calling Party Name Indication (ISDN Trunk) Shows sending caller name on outgoing ISDN calls.	0 = Disable 1 = Enable	0	

Default

Trunk Port Number	Name
1	Line 001
2	Line 002
:	:
200	Line 200

Conditions

None

Feature Cross Reference

- Refer to features in the Input Data table.

Program 14 : Trunk, Basic Setup

14-02 : Analog Trunk Data Setup

Level:
IN

Description

Use **Program 14-02 : Analog Trunk Data Setup** to set the basic options for each analog trunk port. Refer to the table below for a description of each option, its range and default setting.

Input Data

Trunk Port Number	001~200
-------------------	---------

Item No.	Item	Input Data	Default	Related Program
01	Signaling Type (DP/DTMF) Set the signaling type for the trunk.	0 = Dial Pulse (10 PPS) 1 = Dial Pulse (20 PPS) 2 = DTMF	2	
02	Ring Detect Type Set Extended Ring Detect or Immediate Ring Detect for the trunk. For T1 loop/ground start trunks, this option must be set to 1 for the trunks to ring and light correctly.	0 = Normal/delayed 1 = Immediate Ringing	1	
03	Flash Type Select the flash type (open loop flash or ground). Always set this option for open loop flash.	0 = Open Loop Flash 1 = Ground	0	
04	Hooking Type Use Flash for Timed Flash (Program 81-01-14) or Disconnect (Program 81-01-15). (A user implements Flash by pressing the FLASH key while on a trunk call.)	0 = Timed Flash (Hooking) 1 = Disconnect (Cut)	0	81-10-07 81-10-08
05	Dial Tone Detection for Manually Accessed Trunks Enable/Disable dial tone detection for directly accessed trunks. If disabled, the system outdials on the trunks without monitoring for dial tone.	0 = Dial Tone Detection Not Used 1 = Dial Tone Detection Used	0	21-01-04
06	Pause at 1st Digit after Line Seize in Manual Dial Mode	0 = No Pause (No) 1 = Pause (Yes)	1	21-01-06

Item No.	Item	Input Data	Default	Related Program
07	<p>DP to DTMF Conversion Options</p> <p>Determine how a user can convert a Dial Pulse (DP) call to a DTMF call. For each trunk, set the type of DP to DTMF conversion required. There are three conversion options: Automatic (0), Automatic and Manual (1), or Manual (2).</p> <p><i>Automatic:</i></p> <p>DP to DTMF conversion occurs automatically if the extension user waits more than 10 seconds before dialing the next digit.</p> <p><i>Automatic and Manual:</i></p> <p>DP to DTMF conversion occurs automatically if the extension user waits more than 10 seconds before dialing the next digit. In addition, the user can dial # to switch a DP trunk to DTMF dialing.</p> <p><i>Manual:</i></p> <p>Users can dial # to switch a DP trunk to DTMF dialing.</p>	<p>0 = Automatic</p> <p>1 = Automatic and Manual</p> <p>2 = Manual</p>	2	21-01-03
08	Answering Condition	<p>0 = Polarity Reversing (Polarity)</p> <p>1 = Polarity Reversing or Timer (Int Digit)</p>	1	21-01-03
09	Busy Tone Detection	<p>0 = Disable (No)</p> <p>1 = Enable (Yes)</p>	0	
10	<p>Caller ID</p> <p>Enable/Disable a trunk ability to receive Caller ID information.</p>	<p>0 = No</p> <p>1 = Yes</p>	0	
11	<p>Next Trunk in Rotary if No Dial Tone</p> <p>Enable/Disable the system ability to skip over a trunk if dial tone is not detected. This option pertains to calls placed using Speed Dial, ARS, Last Number Redial or Save Number dialed. It does not pertain to line key or Direct Trunk Access calls.</p>	<p>0 = Disable (No)</p> <p>1 = Enable (Yes)</p>	0	
12	Detect Network Disconnect Signal	<p>0 = Disable (No)</p> <p>1 = Enable (Yes)</p>	1	
13	Trunk-to-Trunk Limitation	<p>0 = Disable (No)</p> <p>1 = Enable (Yes)</p>	0	

Item No.	Item	Input Data	Default	Related Program
14	Loop Start/Ground Start	0 = Loop Start (Loop) 1 = Ground Start (Ground)	0	
16	--- Not Used ---			
17	Sync. Ringing Specify whether or not CO/PBX calls follow Synchronous Ringing.  <i>Synchronous Ringing does not apply to incoming DID calls, off-hook ringing calls, or CO/PBX ring transfer calls.</i>	0 = Disable 1 = Enable	1	
18	Busy Tone Detection on Talking	0 = Disable 1 = Enable	0	
19	Busy Tone Detection Frequency	1~255	1	14-02-18
20	Busy Tone Detection Interval	0 = No 1 = Yes	0	14-10
21	Fax Branch Connection	0 = No 1 = Yes	0	
23	Caller ID Receiving Method Rings extension before receiving Caller ID (1) or after receiving Caller ID (0).	0 = Wait Caller ID 1 = Immediate Ring	1	

Conditions

None

Feature Cross Reference

None

Program 14 : Trunk, Basic Setup

14-04 : Behind PBX Setup

Level:
IN

Description

Use **Program 14-04 : Behind PBX Setup** to indicate if the trunk is installed behind a PBX. There is one item for each mode.

Input Data

Trunk Port Number	1~200
-------------------	-------

Item No.	Day/Night Mode	Type of Connection	Default	Related Program
01	1~8	0 = Stand Alone (Trunk) 1 = Behind PBX (PBX) 2 = Not Used 3 = CTX assume 9	0	22-02

Conditions

None

Feature Cross Reference

- Central Office Calls, Placing

Program 14 : Trunk, Basic Setup

14-05 : Trunk Group

Level:
IN

Description

Use **Program 14-05 : Trunk Group** to assign trunks to Trunk Groups. You can also assign the outbound priority for trunks within the group. When users dial up the trunk group, they seize the trunks in the order you specify in the outbound priority entry.

Input Data

Trunk Port Number	001~200
-------------------	---------

Item No.	Trunk Group Number	Priority Number
01	0~100	1~200

Default

Trunk Port	Group	Priority
1	1	1
:	:	:
200	1	200

Conditions

None

Feature Cross Reference

- Trunk Groups

Program 14 : Trunk, Basic Setup

14-06 : Trunk Group Routing

Level:
IN

Description

Use **Program 14-06 : Trunk Group Routing** to set up an outbound routing table for the trunk groups you assigned in Program 14-05. When a user dials 9, the system routes their calls in the order (priority) specified. For example, if a user dials 9 and all calls in the first group are busy, the system may route the call to another group. Trunk Access Map programming (Programs 14-07) may limit this option. The system contains 100 routing tables for trunk access. Each table has four priority orders for trunk access. There are 100 available Trunk Group Numbers.

Example for setting:

With less than four trunk groups,

```
Route Number 1      : Order 1 – Trunk Group 1
                   : Order 2 – Trunk Group 2
```

For the above setting, if all the lines in trunk group 1 are busy, the system searches for an idle line in trunk group 2.

With more than four trunk groups,

```
Route Number 1      : Order 1 – Trunk Group 1
                   : Order 2 – Trunk Group 2
                   : Order 3 – Trunk Group 3
                   : Order 4 – 1002 (Jump To Route Number 2)
Route Number 2      : Order 1 – Trunk Group 4
                   : Order 2 – Trunk Group 5
```

For the above setting, if all the lines in the trunk groups 1, 2 and 3 are busy, the system searches for an idle line in trunk groups 4 and 5.

Input Data

Route Table Number	001~100
--------------------	---------

Item No.	Priority Order Number	Input Data	Related Program
01	1~4	0 = Not Specified 1~100 : (Trunk Group Number) 1001~1100 : (1000 + Route Table Number)	14-01-07 14-05 15-01-02 21-02

Default

- Route 1, Order Number 1 = 1 (Trunk Group 1).
- Order Numbers 2, 3, 4 = 0 (Not Specified).
- All Other Routes (2~100) and Order Numbers (1~4) = 0 (Not Specified).

Conditions

None

Feature Cross Reference

None

Program 14 : Trunk, Basic Setup

14-07 : Trunk Access Map Setup

Level:
IN

Description

Use **Program 14-07 : Trunk Access Map Setup** to set up the Trunk Access Maps. This sets an extension access options for trunks. For example, an extension can place only outgoing calls on trunks to which it has outgoing access. There are 200 Access Maps with all 200 trunk ports programmed in Map 1 with full access.

An extension can use one of the maps you set up in this program. Use Program 15-06 to assign Trunk Access Maps to extensions. Each trunk can have one of eight access options for each Access Map.

 **911 calls will override Program 14-07 settings.**

Input Data

Access Map Number	001~200
-------------------	---------

Item No.	Trunk Port Number	Input Data
01	001~200	0 = No access 1 = Outgoing access only 2 = Incoming access only 3 = Access only when trunk on Hold 4 = Outgoing access and access when trunk on Hold 5 = Incoming access and access when trunk on Hold 6 = Incoming and Outgoing access 7 = Incoming access, outgoing access and access when trunk on Hold

Default

- Access Maps 1~200 = Trunk Ports 1~200 assigned with option 7 access (incoming and outgoing access and access when trunk is on Hold).

Conditions

None

Feature Cross Reference

- Central Office Calls, Answering
- Central Office Calls, Placing

Program 14 : Trunk, Basic Setup

14-08 : Music on Hold Source for Trunks

Level:
IN

Description

Use **Program 14-08 : Music on Hold Source for Trunks** to define a Music on Hold source for a trunk as either the ACI or COI port.

 *If ACI is selected as the source in Item 1, the port number for the source must be selected in Item 2.*

Input Data

Trunk Port Number	001~200
-------------------	---------

Item No.	Item	Input Data	Default
01	MOH Type Select a Music on Hold source for the trunk.	0 = Internal synthesized/external MOH 1 = A customer-provided source connected to BGM port 2 = A customer-provided source connected to ACI port	0
02	Source Port Number	If the MOH Type is 2, the source port number is 0~96.	0

Conditions

None

Feature Cross Reference

- Music on Hold

Program 14 : Trunk, Basic Setup

14-09 : Conversation Recording Destination for Trunks

Level:

IN

Description

Use **Program 14-09 : Conversation Recording Destination for Trunks** to set the ACI Conversation Recording destination for each trunk.

 *If both Programs 14-09 and 15-12 define a destination, the destination in Program 15-12 is followed.*

Input Data

Trunk Port Number	001~200
-------------------	---------

Item No.	Item	Input Data	Default
01	ACI Recording Destination Extension Number Enter the ACI extension number where the trunk calls should be recorded.	Maximum eight digits	No Setting
02	ACI Automatic Recording for Incoming Calls Determine if incoming trunk calls should be automatically recorded in the ACI.	0 = Off 1 = On	0

Conditions

None

Feature Cross Reference

- Analog Communications Interface (ACI)

Program 14 : Trunk, Basic Setup

14-11 : ID Setup for IP Trunk

Level:
IN

Description

Use **Program 14-11 : ID Setup for IP Trunk** to set the ID of each IP Trunk. This program refers to incoming and outgoing IP Trunk calls. The ID is sent on an outgoing IP Trunk call. This program is used only for H.323.

Input Data

Trunk Port Number	001~200
-------------------	---------

Item No.	Item	Input Data	Default
01	IP Trunk ID	0~65535 (0 = No setting)	0

Conditions

- This Data is called IP trunk outgoing call, or IP trunk incoming call.
- This ID is notified at IP trunk outgoing call.
- It is not notified when ID is 0.
- Incoming Call arrives to the trunk port of the same ID as ID notified from the partner system.

Feature Cross Reference

- IP Trunk – H.323

Program 14 : Trunk, Basic Setup

14-12 : SIP Register ID Setup for IP Trunk

Level:
IN

Description

Use **Program 14-12 : SIP Register ID Setup for IP Trunk** to define the SIP Register ID for IP Trunks.

Input Data

Trunk Port Number	001~200
-------------------	---------

Item No.	Item	Input Data	Default
01	Register ID	0 ~ 31	0
02	Pilot Register ID	0 ~ 31	0

Conditions

None

Feature Cross Reference

None

Program 14 : Trunk, Basic Setup

14-13 : CCIS System Route ID

Level:
IN

Description

Use **Program 14-13 : CCIS System Route ID** to define the CCIS route ID to the trunk group used for K-CCIS.

Input Data

Trunk Group Number	001~100
--------------------	---------

Item No.	Trunk Group Number	Input Data	Default	Related Program
01	001~100	0 = Not Assigned 1 ~ 8 =CCIS Route IDs <i>☞ CCIS Route IDs 5~ 8 are for future use and should not be used.</i>	0	14-05-01 50-02-01 50-02-02 50-02-03 50-02-04 50-02-05 50-02-06

Conditions

- Not used for IP-CCIS

Feature Cross Reference

- Key-Common Channel Interoffice Signaling (K-CCIS)

Program 14 : Trunk, Basic Setup

14-14 : CCIS Trunk CIC Assignment

Level:
IN

Description

Use **Program 14-14 : CCIS Trunk CIC Assignment** to define the CIC (Circuit Identifier Code) to each voice channel (trunk port) used for K-CCIS.

Input Data

Trunk Group Number	001 ~ 200
--------------------	-----------

Item No.	Trunk Group Number	Input Data	Default	Related Program
01	001~200	0 = Not Assigned 1~127 = CIC Numbers	0	14-05-01

Conditions

- CIC Numbers must be assigned consecutively for K-CCIS to operate correctly.
- The D-Channel trunk port should not have a CIC assignment.
- This is not used for IP-CCIS.

Feature Cross Reference

- Key-Common Channel Interoffice Signaling (K-CCIS)

THIS PAGE INTENTIONALLY LEFT BLANK

Program 15 : Extension, Basic Setup

15-01 : Basic Extension Data Setup

Level:
SA

Program

15

Description

Use **Program 15-01 : Basic Extension Data Setup** to define the basic settings for each extension.

Input Data

Extension Number	Maximum eight digits
------------------	----------------------

Item No.	Item	Input Data	Default	Related Program
01	Extension Name Define the extension/virtual extension name.	Up to 12 Characters	STA 101 = Ext 101 STA 102 = Ext 102, etc.	
02	Outgoing Trunk Line Preference Set the extension outgoing Trunk Line Preference. If enabled, the extension user receives trunk dial tone when they lift the handset. The user hears trunk dial tone only if allowed by Trunk Access Map programming (Programs 14-07 and 15-06). Refer to the Line Preference feature for more details.	0 = Off 1 = On	0	14-06 21-02
03	SMDR Printout Include/Exclude the extension in the SMDR report.	0 = Do not print on SMDR report 1 = Include on SMDR report	1	

Item No.	Item	Input Data	Default	Related Program
04	ISDN Caller ID If both Program 15-01-04 and 10-03-05 are enabled, the system includes Caller ID in the Setup message as Presentation Allowed. If these options are disabled, it is Presentation Restricted.	0 = Disable 1 = Enable	1	10-03-05 20-08-13
05	Restriction for Outgoing Disable on Incoming Line Enable/Disable supervised dial detection for an extension.	0 = No 1 = Yes	0	21-01-15 21-01-16 21-01-17 80-03-01
07	Do-Not-Call	0 = Off 1 = On	0	21-01-19
08	Call Attendant Busy Message	0~100 (0 = No setting)	0	11-11-59 40-10-08
09	Call Attendant Answer Message	0~100 (0 = No setting)	0	11-11-60 40-10-09
10	Extension Number Sends caller name on outgoing ISDN calls.	0 = Disable 1 = Enable	0	

Conditions

None

Feature Cross Reference

None

Program 15 : Extension, Basic Setup

15-02 : Multiline Telephone Basic Data Setup

Level:

IN

Description

Use **Program 15-02 : Multiline Telephone Basic Data Setup** to set up various multiline telephone options.

Input Data

Extension Number	Maximum eight digits
------------------	----------------------

Item No.	Item	Input Data	Default	Related Program
01	Display Language Selection (To select options 8~10, press either 8 or Recall, then press line keys 1~3. Key 1 is option 8, Key 2 is option 9, and Key 3 is option 10.)	0 = Japanese 1 = English 2 = German 3 = French 4 = Italian 5 = Spanish 6 = Dutch 7 = Portuguese 8 = Norwegian 9 = Danish 10 = Swedish 11 = Turkish 12 = Latin American Spanish 13 = Romanian 14 = Polish	1	11-11-13
02	Trunk Ring Tone Set the tone (pitch) of the incoming trunk ring for the extension port you are programming. <i>DTU/DTP-style telephones only follow high, medium and low range ring tone settings. They do not follow Melodies.</i>	1 = High 2 = Medium 3 = Low 4 = Ring Tone 1 5 = Ring Tone 2 6 = Ring Tone 3 7 = Ring Tone 4 8 = Ring Tone 5	2	22-03

Item No.	Item	Input Data	Default	Related Program
03	<p>Extension Ring Tone</p> <p>Set the tone (pitch) of the incoming extension call ring for the extension port you are programming. Also refer to Program 15-08.</p> <p> <i>DTU/DTP style telephones only follow high, medium and low range ring tone settings. They do not follow Melodies.</i></p>	1 = High 2 = Medium 3 = Low 4 = Ring Tone 1 5 = Ring Tone 2 6 = Ring Tone 3 7 = Ring Tone 4 8 = Ring Tone 5	8	
04	<p>Redial (Speed Dial) Control</p> <p>Control the function of the extension Redial key when used with Speed Dialing. The Redial key can access either the Common or Group Speed Dialing numbers.</p>	0 = Common and Individual Speed Dialing 1 = Group Speed Dialing	0	
05	<p>Transfer Key Operation Mode</p> <p>Set the operating mode of the extension CONF key. The keys can be for Call Transfer, Serial Calling or Flash. When selecting the Flash option (selection 2), refer also to Program 81-01-14.</p>	0 = Transfer 1 = Call back 2 = Hook	0	
06	<p>Hold Key Operating Mode</p> <p>Set the function of the Multiline Hold key. The Hold key can activate normal Hold or Exclusive Hold.</p>	0 = Normal (Common) 1 = Exclusive Hold	0	
07	<p>Automatic Hold for CO Lines</p> <p>When talking on a CO call and another CO line key is pressed, the original trunk is placed on Hold or Disconnected.</p>	0 = Hold 1 = Disconnect (Cut)	1	
08	<p>Automatic Handsfree</p> <p>Set whether pressing a key accesses a One-Touch Key or if it preselects the key.</p>	0 = Preselect 1 = One-Touch (Automatic Handsfree)	1	
10	<p>Ringling Line Preference for Trunk Calls</p> <p>Select between Idle and Ringing Line Preference for trunk calls.</p>	0 = Idle (Off) 1 = Ringing (On)	1	

Item No.	Item	Input Data	Default	Related Program
11	<p>Callback Automatic Answer</p> <p>Enable/Disable automatic answer of calls recalling to a station. For example, if a Transfer Recall or Hold Recall is ringing back to a station, the following happens:</p> <p>If PRG 15-02-11 is enabled, the station automatically answers the recall when it goes off-hook.</p> <p>If PRG 15-02-11 is disabled, a station does not automatically answer the recall when it goes off-hook. The user must first press the line appearance of the recalling call or press the answer key.</p>	<p>0 = Off</p> <p>1 = On</p>	1	
12	<p>Off-Hook Ringing</p> <p>Set the telephone Off-Hook signaling. Off-hook signaling occurs when a telephone user receives a second call while busy on a handset call. To enable/disable Off-Hook Signaling for an extension Class of Service, use Program 20-13-06.</p>	<p>0 = Muted Off-Hook Ringing</p> <p>1 = No Off-Hook Ringing</p> <p>2 = Not Used</p> <p>3 = Beep in Speaker (SP)</p> <p>4 = Beep in Handset (HS)</p> <p>5 = Speaker & Handset Beep</p>	5	
13	<p>Redial List Mode</p> <p>Select whether the Redial List feature should store internal and external numbers (0), or only external numbers (1).</p>	<p>0 = ICM/Trunk (Extension/Trunk Mode)</p> <p>1 = Trunk Mode</p>	1	
15	<p>Storage of Caller-ID for answered call</p>	<p>0 = Disable (Off)</p> <p>1 = Enable (On)</p>	1	
16	<p>Handsfree Operation</p> <p>Enable/Disable an extension user ability to use the speakerphone on outside calls. When disabled, users can hear the conversation, but cannot respond handsfree.</p>	<p>0 = Disable (Off)</p> <p>1 = Enable (On)</p>	1	
18	<p>Power-Saving Mode</p>	<p>0 = Normal mode</p> <p>1 = Power-Saving Mode (Eco-Mode)</p>	1	20-02-10
19	<p>CTA Data Communication Mode</p> <p>Select 0 if the dip switch settings on the CTA Adapter are set to PC connection (1=on, 2~8=off) or select 1 if the DIP switches are set to printer connection (1~2=on, 3~8=off).</p>	<p>0 = CTI Mode</p> <p>1 = Non Procedural Mode (Non-SCS)</p>	0	15-02-20

Item No.	Item	Input Data	Default	Related Program
20	Baud Rate for CTA Port Select the baud rate used by the CTA Adapter.	0 = 4800 1 = 9600 2 = 19200	2	15-02-19
21	Virtual Extension Access Mode (when idle Virtual Extension key pressed) Determine whether a Virtual Extension/Call Arrival Key(CAR) should function as a DSS key, a Virtual Extension, or a CAR key. When DSS (0) is selected, the key functions as a DSS key to the extension and for incoming calls to that extension. When Outgoing (1) is selected, the key functions as a virtual extension and can be used for incoming and outgoing calls. When Ignore (2) is selected, the key functions as a CAR key and can receive incoming calls only.	0 = DSS 1 = Outgoing (OTG) 2 = Ignore	2	
22	Multiple Incoming From Intercom and Trunk If enabled, this affects how a Hotline key lights, based on the setting in Program 22-01-01. If 22-01-01 is set to 1 for trunk priority, the Hotline key lights solid when a trunk call rings in. If 22-01-01 is set to 0 for intercom priority, the Hotline key does not light for incoming trunk calls, but lights solid for intercom calls. If 15-02-22 is disabled, Hotline keys light solid for any incoming calls regardless of the setting in Program 22-01-01.	0 = Disable 1 = Enable	1	22-01-01
23	Speed Dial Preview Mode Define how a speed dial key functions when pressed. If set to Preview (0), the speed dial number can be previewed before dialing. If set to Outgoing Immediately (1), the number is dialed immediately.	0 = Preview 1 = Outgoing Immediately	0	

Item No.	Item	Input Data	Default	Related Program
24	<p>Conference Key Mode</p> <p>Allow an extension Conf key to be programmed for Conference or for Transfer. When set for 1, the user places a call on hold, dials the extension to which it should be transferred, then presses the Conf key. The call is then transferred. When set for 0, with an active call, the user presses the Conf key, places a second call, then presses the Conf key twice. All the calls are then connected.</p>	<p>0 = Conference</p> <p>1 = Transfer</p>	0	
26	<p>MSG Key Operation Mode</p> <p>Determine whether an extension MSG key should function as a Message key or Voice Mail key. If set as a Message key, users can press the key to call the voice mail only when they have new messages.</p>	<p>0 = Message Key</p> <p>1 = Voice Mail Key</p>	0	
27	<p>Handset Volume</p> <p>Determine how an extension handset volume is set after it is adjusted during a call.</p> <p><i>When 1 is assigned in this program and a user sets the volume to maximum, the volume is reset to a level to meet FCC standards when the user hangs up.</i></p>	<p>0 = Back to Default (Back)</p> <p>1 = Stay at previous level (Stay)</p>	1	
28	<p>Message Waiting Lamp Color</p> <p>Determine whether an extension Message Waiting Lamp lights Green or Red when a message is received.</p>	<p>0 = Green</p> <p>1 = Red</p>	1	<p>15-02-35</p> <p>15-02-36</p> <p>15-02-37</p> <p>15-02-38</p>
29	<p>PB Back Tone Level</p> <p>Allow adjustment of the PB Back Tone Level when you are calling an ISDN Line.</p>	1~63 (-15.5dB ~ +15.5dB)	32 (0dB)	
30	<p>Toll Restriction Class</p> <p>Select the Toll Restriction Class to use when placing a call from a virtual extension.</p>	<p>0 = Vir. Ext. (Virtual Extension Class)</p> <p>1 = Real Ext. (Real Extension Class)</p>	1	
34	<p>Call Register Mode</p> <p>The Caller ID Scroll stores Trunk calls only (0), or both Internal and Trunk calls (1).</p>	<p>0 = Trunk Mode</p> <p>1 = Extension/Trunk Mode</p>	0	

Item No.	Item	Input Data	Default	Related Program
35	Message Waiting Lamp Cycle for Calling Extension Select the cycle method that the Large LED flashes when the extension has set Message Waiting.	1 = Cycle 1 2 = Cycle 2 3 = Cycle 3 4 = Cycle 4 5 = Cycle 5 6 = Cycle 6 7 = Cycle 7	7	15-02-28 15-02-36 15-02-37 15-02-38
36	Message Waiting Lamp Cycle for Called Extension Select the cycle method that the Large LED flashes when the extension has Message Waiting set to the extension.	1 = Cycle 1 2 = Cycle 2 3 = Cycle 3 4 = Cycle 4 5 = Cycle 5 6 = Cycle 6 7 = Cycle 7	3	15-02-28 15-02-35 15-02-37 15-02-38
37	Voice Mail Message Wait Lamp Color Select the color of the Large LED when a voice mail message is waiting at the extension.	0 = Green 1 = Red	1	15-02-28 15-02-35 15-02-36 15-02-38
38	Voice Mail Message Wait Lamp Cycle Select the cycle method that the Large LED flashes when the extension has a VM Message Waiting set to the extension.	1 = Cycle 1 2 = Cycle 2 3 = Cycle 3 4 = Cycle 4 5 = Cycle 5 6 = Cycle 6 7 = Cycle 7	3	15-02-28 15-02-35 15-02-36 15-02-37
40	Additional Dial for Caller ID Call Return Enter the digits to be dialed in front of the Caller ID when using the Caller ID Return function.	Up to four digits (0, 1~9, #, *)		10-02-04
41	Incoming Ring Setup	0 = Speaker Normal Ring 1 = Headset Ring	0	
42	Incoming Off-Hook Ring Setup	0 = Speaker Off-Hook Ring 1 = Headset Off-Hook Ring	0	
43	Headset Ring Duration	0 = No Switch to Speaker Ring 1 = 10 seconds 2 = 20 seconds 3 = 30 seconds 4 = 40 seconds 5 = 50 seconds 6 = 1 minute	0	

Item No.	Item	Input Data	Default	Related Program
44	Reversing Display Indication The display on the DT300/DT700 style telephones can be set to Normal or Reversed.	0 = Normal Indication 1 = Reversing Indication	0	
45	Double Height Character Indication On the DT300/DT700 style phones Name and Number Line (2), Calender Line (1) or No Line (0) set to has double height characters.	0 = Normal Indication 1 = Double height character indication of calendar display line 2 = Double height character indication of name and number display line	0	
46	Backlight LCD duration On the DT300/DT700 style phones set the time the Backlight LCD stays on.	0 = Continuous on 1 = 5 seconds 2 = 10 seconds 3 = 15 seconds 4 = 30 seconds 5 = 60 seconds	2	
47	Icon display of DESI-less On the DTL/ITL-8LD style phones are icons displayed (1), or not displayed (0).	0 = Off 1 = On	1	11-11-17 15-07-01 15-20-01
48	Short Ring Setup	0 = Disable 1 = Enable	0	80-09-01
49	Button Kit Information for Multiline Telephone	0 = No setting 1 = Not Used 2 = Type-A with Cursor Key 3~9 = Not Used 10 = Type-A without Cursor Key (Retrofit)	0	90-48-01
51	Alarm Notification to other NetLink System	0 = Disable 1 = Enable	1	20-08-16
52	Voice Mail Message Waiting Lamp Setup	0 = Light the VM function key only. 1 = Light the Message Waiting lamp only. 2 = Light the MW lamp and VM key.		15-07-01
54	Menu Operation Mode	0 = Automatic Close 1 = Manual Close	0	

Table 2-4 Lamp Cycle On/Off Timing Pattern

Programs 15-02-35, 36, and 38		
Input		Cycle
1	Cycle 1	500ms – ON / 500ms – OFF
2	Cycle 2	250ms – ON / 250ms – OFF
3	Cycle 3	125ms – ON / 125ms – OFF
4	Cycle 4	125ms – ON / 125ms – OFF / 125ms – ON / 625ms – OFF
5	Cycle 5	875ms – ON / 125ms – OFF
6	Cycle 6	625ms – ON / 125ms – OFF / 125ms – ON / 125ms – OFF
7	Cycle 7	1000ms – ON

Table 2-5 Program 15-02 – Incoming Signal Frequency Patterns

Incoming Signal Frequency Pattern	Type	Frequency 1	Frequency 2	Modulation
External Incoming Signal Frequency (Pattern 1)	High Middle Low	1100 660 520	1400 760 660	16Hz 16Hz 16Hz
External Incoming Signal Frequency (Pattern 2)	High Middle Low	1100Hz 660Hz 520Hz	1400Hz 760Hz 660Hz	8Hz 8Hz 8Hz
External Incoming Signal Frequency (Pattern 3)	High Middle Low	2000Hz 1400Hz 1100Hz	760Hz 660Hz 540Hz	16Hz 16Hz 16Hz
External Incoming Signal Frequency (Pattern 4)	High Middle Low	2000Hz 1400Hz 1100Hz	760Hz 660Hz 540Hz	8Hz 8Hz 8Hz
Internal Incoming Signal Frequency	High Middle Low	1100Hz 660Hz 520Hz	1400Hz 760Hz 660Hz	8Hz 8Hz 8Hz

Conditions

None

Feature Cross Reference

- Refer to the Input Data chart.

Program 15 : Extension, Basic Setup

15-03 : Single Line Telephone Basic Data Setup

Level:
IN

Description

Use **Program 15-03 : Single Line Telephone Basic Data Setup** to set up various single line telephone options.

Input Data

Extension Number	Maximum eight digits
------------------	----------------------

Item No	Item	Input Data	Default	Related Program
01	<p>SLT Signaling Type</p> <p>Select the type of dialing the connected telephone uses.</p> <p>For the UNIVERGE SV8100 Wireless telephones to function correctly, this must be set to 0. If this option is set for DTMF, after an outside call is placed, the system cannot dial any additional digit.</p> <p>This program change is automatically performed when the UNIVERGE SV8100 Wireless telephone is registered. When upgrading software from prior versions, the previous default of 1 is saved from the prior database so this option must be changed manually.</p>	0 = DP 1 = DTMF	1	15-03-03 45-01-01
03	<p>Terminal Type</p> <p>Enter 1 for this option to allow a single line port to receive DTMF tones after the initial call setup. Enter 0 to have the port ignore DTMF tones after the initial call setup. For Voice Mail, always enter 1 (e.g., receive DTMF tones).</p>	0 = Normal 1 = Special	0	15-03-01 45-01-01
04	<p>Flashing</p> <p>Enable/Disable Flash for single line (500/2500 type) telephones.</p>	0 = No 1 = Yes	1	
05	<p>Trunk Polarity Reverse</p> <p>Not Used in U.S. – Do Not Change Default Entry as DTMF issues may arise with voice mail.</p>	0 = Off 1 = On	0	

Item No	Item	Input Data	Default	Related Program
06	Extension Polarity Reverse Not Used in U.S. -- Do Not Change Default Entry as DTMF issues may arise with voice mail.	0 = Disable (Off) 1 = Enable (On)	0	
07	Enabled On-Hook When Holding (SLT)	0 = No 1 = Yes	1	11-12-45
08	Answer On-Hook when Holding (SLT)	0 = Disable (No) 1 = Yes (Enable)	1	11-12-46
09	Caller ID Function - For External Module Enable/Disable the Caller ID FSK signal for an external Caller ID module or a 3rd party vendor telephone with Caller ID display. Important: If voice mail is used, this setting must be disabled for the system integration codes to be correct.  <i>With a 2500 set (no Caller ID) installed, this must be set to 0 for incoming callers to have a talk path.</i>	0 = Disable (Off) 1 = Enable (On)	0	
10	Caller ID Name Determine if an extension user telephone should display the Caller ID name.	0 = Disable 1 = Enable	1	15-03-09
11	Caller ID Type Determine whether the Caller ID type is FSK or DTMF.	0 = FSK 1 = DTMF	0	
14	Forwarded Caller ID Display Mode Determine what the display shows when a multiline terminal receives a forwarded outside call.	0 = Calling Extension Number (Calling) 1 = External Caller ID (Forward)	0	
15	Disconnect without dial after hooking hold Determine whether or not to disconnect a held call when on-hook without any dialing after hooking-hold.	0 = Normal 1 = Disc.	0	
16	Special DTMF Protocol Send Determine whether or not to send the extension number of the phone forwarded to the extension when PRG 15-03-03 is set to Special (1) and not in the VM group.	0 = No 1 = Yes	0	

Item No	Item	Input Data	Default	Related Program
17	Dial Tone Select When the function of MW was set from another extension or VM, the dial tone is selected upon off hook.	0 = Normal 1 = New DT	0	

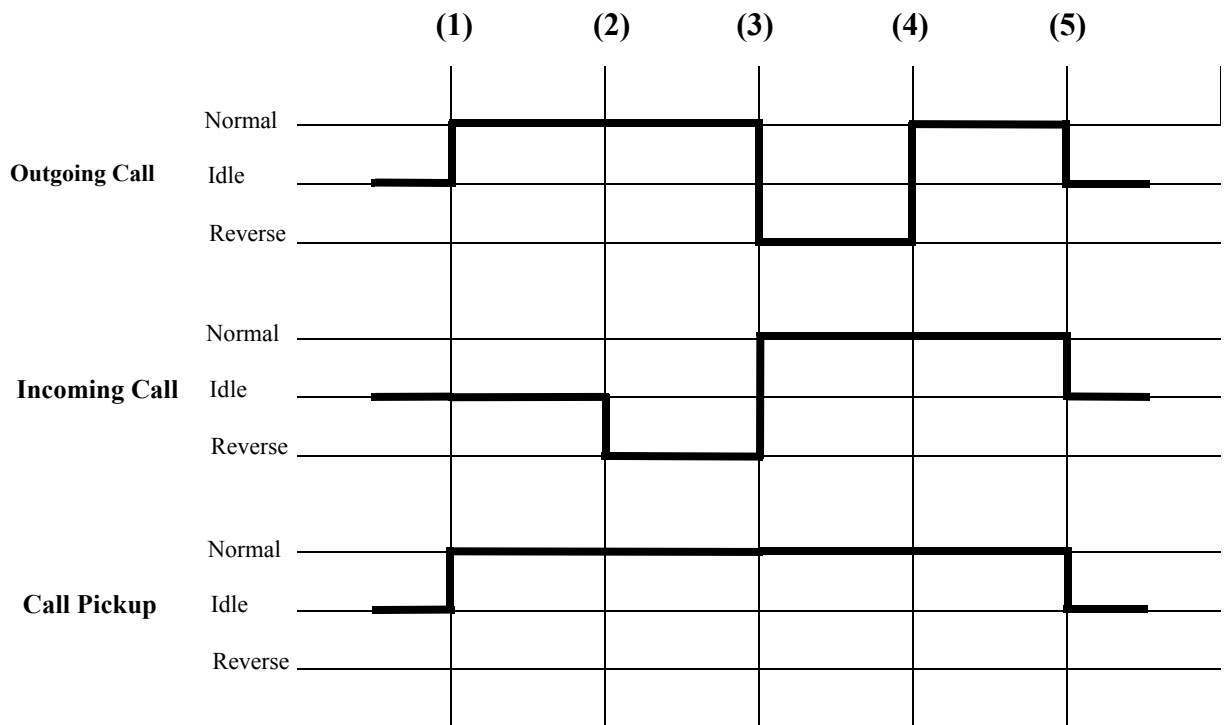

(1) = Off-Hook (2) = Calling/Ringing (3) = Answer (4) = Detect Hang Up (5) = On-Hook

Conditions

None

Feature Cross Reference

- Single Line Telephones, Analog 500/2500 Sets

Program 15 : Extension, Basic Setup

15-05 : IP Telephone Terminal Basic Data Setup

Level:
IN

Description

Use **Program 15-05 : IP Telephone Terminal Basic Data Setup** to set up the basic settings for an IP telephone.

Input Data

Extension Number	Maximum eight digits
------------------	----------------------

Item No.	Item	Input Data	Default	Description	Related Program
01	Terminal Type	0 = NGT 1 = H.323 2 = SIP 3 = MEGACO 4 = SIP-MLT	0	Viewing Only – No changes permitted	
02	IP Phone Fixed Port Assignment	MAC address 00-00-00-00-00-00 to FF-FF-FF-FF-FF-FF	00-00-00-00-00-00	MAC Address of registered SIP MLT phone is stored and/or can input the MAC address of an SIP MLT phone so when it comes online it is provided with the extension in which the MAC address matches.	15-05-01
04	Nickname	Up to 48 characters	No setting	Nickname section on Invite message. Example: Extension 100 has a Nickname set to PAUL. Extension 101 has command 15-05-17 set to Nickname. The inbound call to extension 101, from 100, shows PAUL.	15-05-17
07	Using IP Address	0.0.0.0~255.255.255.255	0.0.0.0	Informational Only registered IP Phones	15-05-01
15	CODEC Type	1-Type 1 2-Type 2 3-Type 3 4-Type 4 5-Type 5	1	Assign the CODEC Type of the MLT SIP.	84-24-XX

Item No.	Item	Input Data	Default	Description	Related Program
16	Authentication Password	Up to 24 characters	None	Assign the authentication password for SIP single line telephones.	15-05-01
17	Calling Party Display Info	0 = Nickname 1 = Display Name 2 = User Part 3 = Extension	0	The part of the Invite message the calling party information is taken from. There are four choices: Nickname: Displays the nickname programmed in 15-05-04. Display Name: Some SIP phones have a Field called Display Name. If configured, in the SIP phone, this displays upon a call from that station. User Part: Some SIP phones have a field called User Part. If configured in the SIP phone, this displays upon a call from that station. Extension: Display shows extension of the SIP phone.	
18	IP Duplication Allowed Group	0 = Not Used 1 = Group 1 2 = Group 2 3 = Group 3 4 = Group 4 5 = Group 5 6 = Group 6 7 = Group 7 8 = Group 8 9 = Group 9 10 = Group 10	0	If an adapter has one IP address coming into it but has multiple extensions off of it. Assign all the extensions to a group so the CPU knows that the one IP address is assigned to multiple extensions.	15-05-01
19	Side Option Information	0 = No Option 1 = 8LK Unit 2 = 16LK Unit 3 = 24ADM	0	This is a read only program that shows what type of Line Key unit is installed on the ITH-style telephone.	10-03-09 15-05-22
20	Bottom Option Information	0 = No Option 1 = ADA 2 = BHA	0	This is a read only program that shows what type of adapter is installed on the ITH-style telephone.	10-03-10
21	Handset Option Information	0 = Normal Handset 1 = Handset for power failure (PSA/PSD) 2 = BCH	0	This is a read only program that shows what type of Handset is installed on the ITH-style telephone.	10-03-11 15-05-23

Item No.	Item	Input Data	Default	Description	Related Program
22	Side Option Additional Data	0 = No Setting 1~32 = DSS Console number	0	This is a read only program that shows the DSS console number when one is installed on a ITH-style telephone.	30-01 30-02 30-03 30-04 30-05 30-06
23	Handset Option Additional Information	0 = No Setting 1~16 = Terminal equipment number (TEN) of Bluetooth Cordless Handset (BCH)	0	Determine to use TEN or not.	
24	Protection Service	0 = Not Used 1 = Used	0	When enabled this allows the MLT SIP telephones to use the security key. If disabled, and the key is pressed, nothing happens.	90-40-01 90-40-02
26	DT700 Terminal Type	0 = Not Set 1 = ITL-()E-1D/IP- ()E-1 2 = ITL-()D-1D/ITL-24BT1D/ITL- 4PA-1D [without 8LKI(LCD)-L] 3 = ITL-()D-1D/ITL-24BT1D/ITL-24PA-1D [with 8LKI(LCD)-L] 4 = ITL-320C-1 5 = Softphone 6 = CTI 7 = AGW	0		
27	Personal ID Index	0~512	0	Used when the SIP Multiline telephone is using manual/ auto registration. Assign each phone a unique personal index. Then go to command 84-22 to assign the user name and password.	84-22-XX
28	Addition Information Setup	0 = Do not inform 1 = Inform	0	Select whether or not to inform of additional information.	
29	Terminal WAN-side IP Address	0.0.0.0~255.255.255.255	0.0.0.0		
30	DTMF Play during Conversation at Receive Extension	0 = Do Not Play 1 = Play	0		

Item No.	Item	Input Data	Default	Description	Related Program
31	Alarm Tone during Conversation (RTP packet loss alarm)	0 = Off 1 = On	1		
32	Ten Key Pad Talkie	0 = Off 1 = On	0		
33	LAN Side IP Address of Terminal	0.0.0.0~255.255.255.255	0.0.0.0	Read-only	
34	Terminal Touch Panel On/Off	0 = Off 1 = On	1	Select whether the touch screen used on ITL-320C-1 (BK) TEL can be used (1) or cannot be used (0).	
35	Encryption Mode	0 = Off 1 = On	0		
36	DT700 Firmware Version	00.00.00.00~FF.FF.FF.FF	00.00.00.00		
37	DT700 Large LED Illumination Setup	2 = Red 3 = Green 4 = Blue 5 = Yellow 6 = Purple 7 = Light Blue 8 = White 9 = Rotation	3	Sets LED color for internal Intercom call. In DT700 local terminal setting menu, illumination setting must be 'Automatic', otherwise the terminal will ignore PRG 14-01-35, PRG 15-05-37 and PRG 15-23 settings.	
38	Paging Protocol Mode	0 = Multicast 1 = Unicast 2 = Auto	0	Sets the protocol mode for the Paging function.	
39	CTI Override Mode	0 = Disable 1 = Enable	0	Sets the override function against the terminal that is controlled by the CTI.	

Conditions

- 15-05-04 – Nickname must be unique in the system.

Feature Cross Reference

None

Program 15 : Extension, Basic Setup

15-06 : Trunk Access Map for Extensions

Level:
IN

Description

Use **Program 15-06 : Trunk Access Map for Extensions** to define the trunk access map for each extension. An extension can place only outgoing calls on trunks to which it has outgoing access. Use Program 14-07 to define the available access maps.

Input Data

Extension Number	Maximum eight digits
------------------	----------------------

Day/Night Mode	1~8
----------------	-----

Item No.	Trunk Access Map Number	Default	Related Program
01	1~200	1	14-07

Conditions

None

Feature Cross Reference

- Central Office Calls, Answering
- Central Office Calls, Placing

Program 15 : Extension, Basic Setup

15-07 : Programmable Function Keys

Level:
SA

Description

Use **Program 15-07 : Programmable Function Keys** to assign functions to a multiline terminal line keys.

For certain functions, you can append data to the key basic function. For example, the function 26 appended by data 1 makes a Group Call Pickup key for Pickup Group 1. You can also program Function Keys using Service Codes.

To clear any previously programmed key, press **000** to erase any displayed code.

Input Data

Extension Number	Maximum eight digits
------------------	----------------------

Default Settings

Line Key	Function Number	Additional Data
LK01	*01 (Trunk Line Key)	1
:	:	:
LK08	*01 (Trunk Line Key)	8
LK09	0 (No Setting)	0
:	:	:
LK48	0 (No Setting)	0

Item No.	Line Key Number	Function Number	Additional Data
01	1~48	0~99 (Normal Function Code) (Service Code 751 by default) * 00 ~ *99 (Appearance Function Code) (Service Code 752 by default)	Refer to Function Number List .

Default

Programmable keys 1~8 are Trunk Line keys (key 1 = Trunk Line 1, key 2 = Trunk Line 2, etc.). All other programmable keys are undefined.

Function Number List

[1] Normal Function Code (00 ~ 99) (Service Code 751)

Function Number List [1] Normal Function Code (00 ~ 99) (Service Code 751)

Function Number	Function	Additional Data	LED Indication
00	Not Defined		
01	DSS/One-Touch	Extension number or any numbers (up to 24 digits)	Red On: Extension Busy Off: Extension Idle Rapid Blink (Red): DND or Call Forward
02	Microphone Key (ON/OFF)		Red On: Mic Off Off: Mic On
03	DND Key		Red On: DND
04	BGM (ON/OFF)		Red On: BGM On Off: BGM Off
05	Headset		Red On: Headset in use
06	Transfer Key		None
07	Conference Key		Red On: Conference call setup occurring
08	Incoming Call Log		Rapid Blink (Red): New call log Red On: Call log Off: No call log
09	Day/Night Mode Switch	Mode number (1~8)	Red On: Mode active
10	Call Forward – Immediate		Red On: Forwarded

Function Number List (Continued)
[1] Normal Function Code (00 ~ 99) (Service Code 751)

Function Number	Function	Additional Data	LED Indication
11	Call Forward – Busy		Red On: Forwarded
12	Call Forward – No Answer		Red On: Forwarded
13	Call Forward – Busy/No Answer		Red On: Forwarded
14	Call Forward – Both Ring		Red On: Forwarded
15	Follow Me		Rapid Blink (Red): Forwarded
18	Text Message Setup	Message Numbers (01~20)	Red On: Feature activated by Function Key
19	External Group Paging	External Paging Number (1~8)	Red On: Page Active
20	External All Call Paging		Red On: Page Active
21	Internal Group Paging	Internal Paging Number (01~64)	Red On: Page Active
22	Internal All Call Paging		None
23	Meet-Me Answer to Internal Paging		None
24	Call Pickup		None
25	Call Pickup for Another Group		None
26	Call Pickup for Specified Group	Call Pickup Group Number	None
27	Speed Dial – Common/Private	Speed Dial Number (Common / Private)	None
28	Speed Dial – Group	Speed Dial Number (Group)	None
29	Repeat Redial		Red On: Waiting to redial
30	Saved Number Redial		None
31	Memo Dial		None
32	Meet – Me Conference		None
33	Override (Off-Hook Signaling)		None
34	Break – In		None
35	Camp On		Red On: While camp-on activated

Function Number List (Continued)
[1] Normal Function Code (00 ~ 99) (Service Code 751)

Function Number	Function	Additional Data	LED Indication
36	Step Call		None
37	DND/FWD Override Call		None
38	Message Waiting		None
39	Room Monitoring		Rapid Blink (Red): While being monitored Slow Blink (Red): While monitoring
40	Handset Transmission Cutoff		Red On: Transmission cut-off
41	Buzzer	Extension Number	Red On: Transmission Side Rapid Blink (Red): Receiver Side
42	Boss – Secretary Call	Extension Number	Red On: Boss – Secretary mode
43	Series Call		None
44	Common Hold		None
45	Exclusive		None
46	Department Group Log Out		Red On: Logged Out
47	Reverse Voice Over	Extension Number	Red On: extension busy Off: extension idle Rapid Blink (Red): DND or Call Forward Green: Reverse Voice Over to extension in progress
48	Voice Over		Slow Blink (Red): Voice Over – Active
49	Call Redirect	Extension Number or Voice Mail Number	None
50	Account Code		Red On: While account code being entered
51	General Purpose Relay	Relay No (0, 1~8)	Red On: Relay On
52	Automatic Answer with Delay Message Setup	Incoming Ring Group (001~100)	Red On: Under setting
53	Automatic Answer with Delay Message Start		Red On: Active
54	External Call Forward by Door Box		Red On: Active
55	Extension Name Change		None

Function Number List (Continued)
[1] Normal Function Code (00 ~ 99) (Service Code 751)

Function Number	Function	Additional Data	LED Indication
56	General Purpose LED Operation		Blink (Red): Active
57	General Purpose LED Indication		Blink (Red): Active
58	Automatic Transfer at Department Group Call	Extension Group Number (01~64)	Blink (Red): Active
59	Delayed Transfer at Department Group Call	Extension Group Number (01~64)	Blink (Red): Active
60	DND at Department Group Call	Extension Group Number (01~64)	Blink (Red): Active
61	--- Not Used ---		
63	Outgoing Call Without Caller ID (ISDN)		Red On: Active
64	--- Not Used ---		
66	CTI		Red On: CTI active
67	--- Not Used ---		
68	--- Not Used ---		
70	--- Not Used ---		
71	--- Not Used ---		
72	Keypad Facility Key		
73	Keypad HOLD Key		
74	Keypad RETRIEVE Key		
75	Keypad Conference Key		
76	--- Not Used ---		

Function Number List (Continued)
[1] Normal Function Code (00 ~ 99) (Service Code 751)

Function Number	Function	Additional Data	LED Indication
77	Voice Mail	Extension Number or Pilot Number	<InMail> Fast Flash (Green): New Message(s) in own Mailbox. Slow Flash (Red): New Message(s) in other Mailbox. <APSU(VM00)/External VM> Red On: Access to Voice Mail Fast Flash (Green): New Message(s) in own Mailbox. Slow Flash (Red): New Message(s) in other Mailbox.
78	Conversation Recording – Voice Mail		Rapid Blink (Red): Recording
79	Automated Attendant (In-Skin)	Extension Number or Pilot Number	Red On: Set Up for All Calls Fast Blink (Red): Set Up for No Answer Calls Stutter Blink (Red): Set Up for Busy Calls Slow Blink (Red): Set Up for Busy/No Answer Calls
80	Tandem Ringing	1 = Set 0 = Cancel Extension Number to Tandem Ring	Red On: Active
81	Automatic Transfer to Transfer Key	Trunk Line No. (001~200)	Slow Flash: Set
82	<i>D^{term}</i> IP Call Log		
83	Conversation Recording Function (VMSU)	0 = Pause 1 = Re-recording 2 = Address 3 = Erase 4 = Urgent Page	
84	Drop Key	None	
85	Directory Dialing		
86	Private Call Refuse	None	Slow Flash: Set
87	Caller ID Refuse	None	Slow Flash: Set

Function Number List (Continued)
[1] Normal Function Code (00 ~ 99) (Service Code 751)

Function Number	Function	Additional Data	LED Indication
88	Dial-In Mode Switching	PRG 22-17 Table No. (1~100)	Off: Pattern 1, Pattern 5~8 On: Pattern 2 Slow flash: Pattern 3 Fast flash: Pattern 4
89	Do-Not-Call Setup		
90	Do-Not-Call Data Registration		
91	Live Recording Key SV8100 InMail		
94	Call Attendant		Fast flash: Setup – No Answer Calls Slow flash: 125ms:on → 125ms:off → 125ms:on → 625ms:off On: Setup – Busy/No Answer Calls
97	Door Box Access Key	Door Box Number (1~8)	On: Door Box Busy Off: Door Box Idle Fast flash: Door Box Incoming
98~99	--- Not Used ---		

Function Number List
[2] Appearance Function Level (*00 ~*99) (Service Code 752)

Function Number	Function	Additional Data	LED Indication
*00	ICM Key	None	Red On: Off Hook on Intercom Call Red Blink: Intercom Call on Hold
*01	Trunk Key	Trunk Number (001~200)	Red On: Trunk Busy by Another User Green On: Trunk Busy by Extension
*02	Trunk Group	Trunk Group Number (001~100)	Red On: Trunk Busy by Another User Green On: Trunk Busy by Extension
*03	Virtual Extension Key	Extension Number or Department Group Number	Red On: Trunk busy by another user Slow Blink (Red): Incoming Call
*04	Park Key	Park Number (01~64)	Slow Blink (Red): Call Placed in Park by Another User Fast Blink (Green): Extension Placed Call in Park

Function Number List (Continued)
[2] Appearance Function Level (*00 ~*99) (Service Code 752)

*06	Trunk Access Via Networking	Network System Number (01~50)	
*07	Station Park Hold None		
*08	CAP Key	CAP Orbit No. (0001~9999) <i>If CAP Orbit No.0000 is used, the next available orbit is automatically selected.</i>	
*10	ACD Log-In/Log-Out		Red On: Under log-on Off: Under log-off
*12	ACD Emergency Call		Red On: Under monitor, Override, Standby Fast Blink (Red): Supervisor Telephone Receiving Emergency Call
*13	ACD Off Duty Mode		Red On: Under Off Duty Slow Blink (Red): Under Reservation
*14	ACD Start/End		Red On: ACD Operation End
*15	ACD Terminal Speech Monitor		Red On: Under Monitor
*16	ACD Waiting		Red On: Standby
*17	ACD Work Wrap Up Time		Red On: Under Work Time Slow Blink (Red): Under Reservation
*18	ACD Overflow Control	ACD Group Number	Red On: Enable Slow Blink (Red): Disable
*19	ACD Queue Status Display Check		

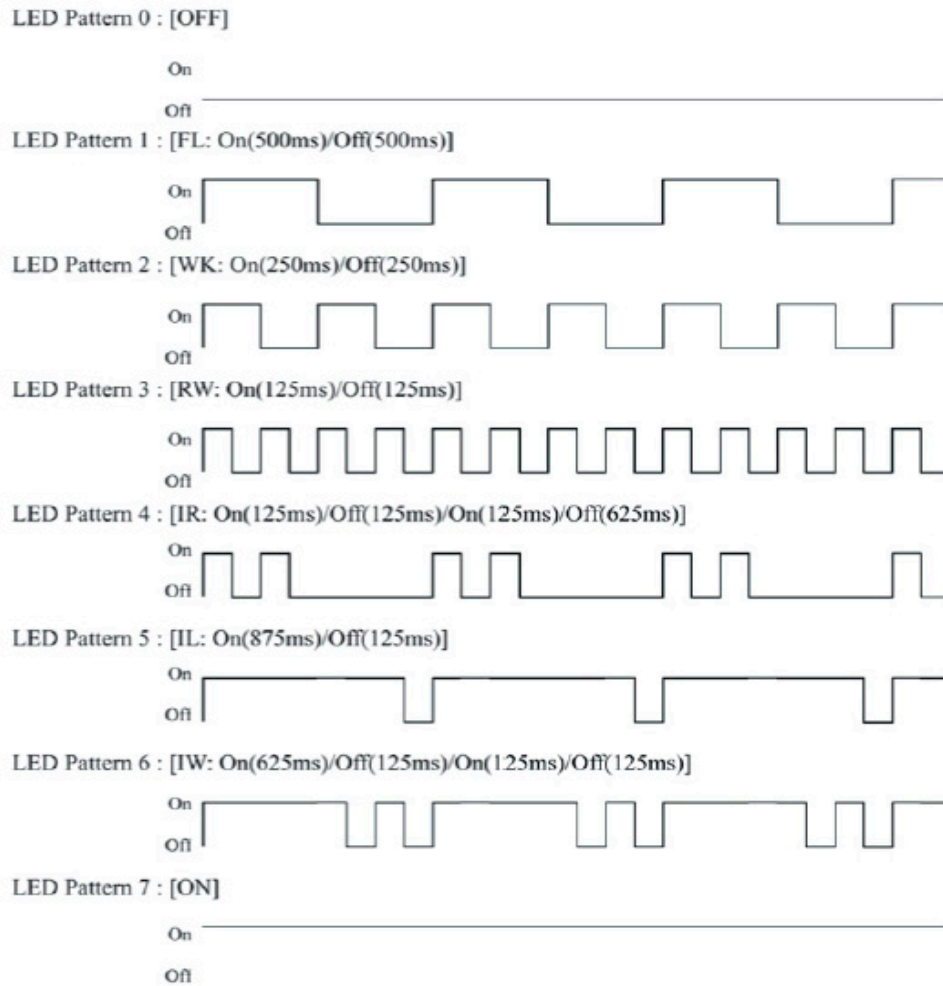
**LED Indication Reference:**

ON = LED pattern 7 (On).

OFF = LED pattern 0 (Off).

Rapid Blink = LED pattern 3 (RW).

Slow Blink (General Function Level) = LED pattern 5 (IL).

Slow Blink (Appearance Function Level) = LED pattern 1 (FL).

Fast Blink = LED pattern 3 (RW).

Stutter Blink = LED pattern 4 (IR).

Conditions

- When a key is programmed using service code 752, it cannot be programmed with a function using the 751 code until the key is undefined (000). For example with a Park Key programmed by dialing 752 + *04 must be undefined by dialing 752 + 000 before it can be programmed as a Voice Over key by dialing 751 + 48.
- When assigning a CAP key, *08, an orbit number must be used. If orbit 000 is used, it automatically assigns the next available orbit.

Feature Cross Reference

- Refer to [Function Number List](#).

Program 15 : Extension, Basic Setup

15-08 : Incoming Virtual Extension Ring Tone Setup

Level:

IN

Description

Use **Program 15-08 : Incoming Virtual Extension Ring Tone Setup** to assign a ring tone range (0~4) to incoming virtual extensions assigned to a Virtual Extension key (Program 15-07). If you enable ringing for the key in Program 15-09, the key rings with the tone you set in this program. Also see Program 22-03. The chart below shows the available tones. There are 256 available extension ports.

Input Data

Extension Number	Maximum eight digits
------------------	----------------------

Item No.	Incoming Ring Pattern	Default	Description
01	0 = Tone Pattern 1 1 = Tone Pattern 2 2 = Tone Pattern 3 3 = Tone Pattern 4 4 = Incoming Ring Tone Extension	0 = Tone Pattern 1	When an extension or a virtual extension is assigned to the function key on the key telephone, select the ring tone when receiving a call on that key. For ACD CAR keys, only tone pattern 1 (entry 0) can be used. The remaining patterns are not checked with this feature.

Table 2-6 Program 15-08 – Incoming Signal Frequency Patterns

Incoming Signal Frequency Pattern	Type	Frequency 1	Frequency 2	Modulation
Pattern 1	High Middle Low	1100 660 520	1400 760 660	16Hz 16Hz 16Hz
Pattern 2	High Middle Low	1100 660 520	1400 760 660	8Hz 8Hz 8Hz
Pattern 3	High Middle Low	2000 1400 1100	760 660 540	16Hz 16Hz 16Hz
Pattern 4	High Middle Low	2000 1400 1100	760 660 540	8Hz 8Hz 8Hz
Internal Incoming Signal Frequency	High Middle Low	1100 660 520	1400 760 660	8Hz 8Hz 8Hz

Conditions

None

Feature Cross Reference

None

Program 15 : Extension, Basic Setup

15-09 : Virtual Extension Ring Assignment

Level:
SA

Description

Use **Program 15-09 : Virtual Extension Ring Assignment** to assign the ringing options for an extension Virtual Extension Key or Virtual Extension Group Answer Key which is defined in Program 15-07. You make an assignment for each Night Service Mode.

Assign extension numbers and names to virtual extension ports in Program 15-01. Program Virtual Extension keys in Program 15-07 (code *03). There are 256 Virtual Extension Ports.

Input Data

Extension Number	Up to eight digits
------------------	--------------------

Key Number	01~48
------------	-------

Item No.	Day/Night Mode	Ringing	Default
01	1~8	0 = No Ringing 1 = Ring	0

Conditions

- Program the Multiple Directory Number function keys **NOT** to ring before removing the key from telephone programming.

Feature Cross Reference

None

Program 15 : Extension, Basic Setup

15-10 : Incoming Virtual Extension Ring Tone Order Setup

Level:

SA

Description

Use **Program 15-10 : Incoming Virtual Extension Ring Tone Order Setup** to set the priority (1~4) for the Virtual Extension Ring Tones set in Program 15-08. When Virtual Extension calls ring an extension simultaneously, the tone with the highest order number (e.g., 1) rings. The other keys only flash. There are 256 Virtual Extension ports.

Input Data

Extension Number	Up to eight digits
------------------	--------------------

Item No.	Priority Order	Data	Description	Related Program
01	1~4	0 = Tone Pattern 1 1 = Tone Pattern 2 2 = Tone Pattern 3 3 = Tone Pattern 4 4 = Incoming Extension Ring Tone	When two or more virtual extensions are set on a function key on the telephone, and the tone pattern by which the sound of each extension differs, the priority of ring sound is set up.	15-08

Default

- By default, Virtual Extension ring tones have the following order:

Priority Order	Ring Tone (Set in Program 15-08)
1	0 (Tone Pattern 1)
2	1 (Tone Pattern 2)
3	2 (Tone Pattern 3)
4	3 (Tone Pattern 4)

Conditions

None



Feature Cross Reference

None

Program 15 : Extension, Basic Setup

15-11 : Virtual Extension Delayed Ring Assignment

Level:
SA

Description

Use **Program 15-11 : Virtual Extension Delayed Ring Assignment** to assign the delayed ringing options for an extension Virtual Extension or Virtual Extension Group Answer keys (defined in Program 15-09). You make an assignment for each Night Service Mode. There are 256 Virtual Extension Ports.

Assign extension numbers (Program 11-04) and names (Program 15-01) to virtual extension ports. Program Multiple Directory Number (virtual extension) keys in Program 15-07 (code *03).

Input Data

Extension Number	Maximum eight digits
------------------	----------------------

Key Number	01~48
------------	-------

Item No.	Day/Night Mode	Ringing	Default	Related Program
01	1~8	0 = Immediate Ring 1 = Delayed Ring	0	20-04-03 15-09-01

Conditions

- Program the Virtual Extension keys **NOT** to ring before removing the key from telephone programming.
- PRG 15-09-01 has to be assigned to Ring Immediately before assigning the CAR/VE key to Delay Ring.

Feature Cross Reference

None

Program 15 : Extension, Basic Setup

15-12 : Conversation Recording Destination for Extensions

Level:

IN

Description

Use **Program 15-12 : Conversation Recording Destination for Extensions** to set the ACI Conversation Recording destination for each extension.

 *If both Programs 14-09 and 15-12 define a destination, the destination in Program 15-12 is followed.*

Input Data

Extension Number	Maximum eight digits
------------------	----------------------

Item Number	Item	Input Data	Default
01	ACI Recording Destination Extension Number Enter the ACI extension number to which the trunk calls should be recorded.	Maximum eight digits	No Setting
02	ACI Automatic Recording for Incoming Calls Determine if an extension incoming calls should be automatically recorded to the ACI.	0 = Off 1 = On	0

Conditions

None

Feature Cross Reference

- Analog Communications Interface (ACI)

Program 15 : Extension, Basic Setup

15-14 : Programmable One-Touch Keys

Level:
IN

Description

Use **Program 15-14 : Programmable One-Touch Keys** to define the One-Touch key data for each multiline terminal.

For each UNIVERGE SV8100 Wireless telephone to use the Transfer When Out of Range feature, enter the destination number (up to 24 digits) and name (up to 12 characters) into One-Touch bin 10. Make sure to add any required trunk access codes for outside numbers. If this bin information is changed either through 15-14-01 or through user programming, the destination for the transferred calls is also changed.

Input Data

Extension Number	Maximum eight digits
------------------	----------------------

Key Number	01~10
------------	-------

Item No.	Dial Data	Name	Default
01	1~0, *, #, Pause, Hook-flash, @ (Code for Answer-Wait) Up to 24 digits	Up to 24 Digits	No Setting
02	Name	Up to 12 Digits	No Setting

Default

- No entries for any extension.

Conditions

None

Feature Cross Reference

- One-Touch Keys

Program 15 : Extension, Basic Setup

15-16 : SIP Register ID Setup for Extension

Level:

IN

Description

Use **Program 15-16 : SIP Register Setup for Extension** to define the SIP Register ID for Extensions.

Input Data

Extension Number	Maximum eight digits
------------------	----------------------

Item No.	Item	Input Data	Default
01	Register ID	None, 0~31	None

Conditions

None

Feature Cross Reference

None

Program 15 : Extension, Basic Setup

15-17 : CO Message Waiting Indication

Level:
IN

Description

Use **Program 15-17 : CO Message Waiting Indication** to set the message waiting LED Flash assignment on each CO line.

Input Data

Extension Number including Virtual Extensions	Up to eight digits
---	--------------------

Trunk Port Number	001~200
-------------------	---------

Item No.	Item	Input Data	Default
01	LED Flash Assignment	0 = LED Off 1 = LED On	0

Conditions

None

Feature Cross Reference

None

Program 15 : Extension, Basic Setup

15-18 : Virtual Extension Key Enhanced Options

Level:

IN

Description

Use **Program 15-18 : Virtual Extension Key Enhanced Options** to define the operation when a Virtual Extension Key is pressed.

Input Data

Extension Number including Virtual Extensions	Up to eight digits
---	--------------------

Item No.	Item	Input Data	Default	Related Program
01	Virtual Extension Key Operation Mode Define if calls to a Virtual Extension Key land on the Virtual or on the extension/ CAP/CO appearance. <i>This is assigned for the Virtual Extension Key, not the extension it resides on.</i>	0 = Release 1 = Land on the key	0	20-04-01
02	Display mode when placing a call on Virtual Extension Key Defines if calls to or from a Virtual Extension Key display the Virtual Extension Key name or the name of the extension it resides on.	0 = Secondary Extension Name 1 = Actual Station Name	0	

Default Settings

- If a DIL rings a Virtual Extension, the Virtual Extension Key Operation Mode must be set to **1**, or the multiline terminal must have a CAP Key.

Conditions

None

Feature Cross Reference

None

Program 15 : Extension, Basic Setup

15-19 : System Telephone Book Setup for Extension

Level:
IN

Description

Use **Program 15-19 : System Telephone Book Setup for Extension** to set the operations of the Telephone Book for each extension.

Input Data

Extension Number	Up to eight digits
------------------	--------------------

Item No.	Item	Input Data	Default	Related Program
01	Telephone Book 1	0~100	Port 1 : 1 Port 2 : 2 ⋮ Port 100 : 100	
02	Telephone Book 2	0~100	0	
06	Locking of Telephone Book	0 = On 1 = Off	0	
07	Password	0000~9999 (Fixed four digits)	0000	

Conditions

None

Feature Cross Reference

None

Program 15 : Extension, Basic Setup

15-20 : LCD Line Key Name Assignment

Level:
IN

Description

Use **Program 15-20 : LCD Line Key Name Assignment** to assigns a name to each LCD Line Key of the SV8100 telephones and ADM option. Up to 13 characters can be assigned.

Input Data

Extension Number	Up to 8 digits
Key Number	01~48
Name Assignment	Up to 13 characters

Default Settings

Line Key	Name
LK01	CO 001
:	:
LK06	CO 006
LK07	All Blank
:	:
LK48	All Blank

Conditions

None

Feature Cross Reference

None

Program 15 : Extension, Basic Setup

15-22 : Mobile Extension Setup

Level:
IN

Description

Use **Program 15-22 : Mobile Extension Setup** to set the system information for the Mobile Extension feature.

Input Data

Extension Number	Up to eight digits
------------------	--------------------

Item No.	Item	Input Data	Default
01	Mobile Extension Target Setup Set which Speed Dial bin is used to call when the Mobile extension is called.	0~1999 (0 = No setting/1~1999 = target of mobile extension)	0
02	Connect Confirmation Select when a confirmation (dial *) is required to allow the call to cut over to the called mobile number.	0 = Always 1 = On Analog Line 2 = Never	0
03	Trunk Access Code Select if the Normal or Individual Trunk access is used when making the call to the mobile number.	0 = Use normal trunk access code (11-09-01) 1 = Use individual trunk access code (11-09-02)	0

Conditions

None

Feature Cross Reference

None

Program 15 : Extension, Basic Setup

15-23 : Incoming Virtual Extension Large LED Setup

Level:

IN

Description

Use **Program 15-23 : Incoming Virtual Extension Large LED Setup** to set the color of the large LED, when the Virtual Extension rings.

(Requires software Version 3.00 or higher)

Input Data

Extension Number	Up to eight digits
------------------	--------------------

Item No.	Item	Input Data	Default
01	DT700 Large LED Illumination Setup	2 = Red 3 = Green 4 = Blue 5 = Yellow 6 = Purple 7 = Light Blue 8 = White 9 = Rotation	5

Program 15 : Extension, Basic Setup

15-25 : DESI-less Page Setup

Level:
IN

Description

Use **Program 15-25 : DESI-less Page Setup** to define the page of each DESI-less extension.

Input Data

Extension Number	Up to eight digits
------------------	--------------------

Item No.	Item	Input Data	Default
01	Incoming Call Notify Event Enable or disables the screen number icon on display.	0 = Disable 1 = Enable	1
02	Automatic Screen Change on Incoming Call Automatically changes display to show Incoming Call number.	0 = Disable 1 = Enable	1
03	Automatic Display Setting While Idle This setting set which screen displays during the idle state.	0 = Disable 1~4 = DESI-less Page	0
04	Automatic Display Setting While Speaking This setting set which screen displays while speaking.	0 = Disable 1~4 = DESI-less Page	0

Conditions

None

Feature Cross Reference

None

Program 16 : Department Group Setup

16-01 : Department Group Basic Data Setup

Level:

IN

Program

16

Description

Use **Program 16-01 : Department Group Basic Data Setup** to set the function mode for each department group. There are 64 available Department Groups.

Input Data

Department Group Number	1~64
-------------------------	------

Item No.	Item	Input Data	Default	Related Program
01	Department Name	Maximum 12 characters	No setting	11-07
02	Department Calling Cycle Set the call routing for Department Calling. Routing can be either circular (cycles to all phones in group) or priority (cycles to highest priority extensions first).	0 = Normal Routing (Priority) 1 = Easy – UCD Routing (Circular)	0	16-02
03	Department Routing when Busy (Auto Step Call) Set how the system routes an Intercom call to a busy Department Group member. Intercom callers to the extension can either hear busy or route to the first available department number. This only occurs for calls to the extension directly, not the department number assigned in Program 11-07.	0 = Normal (Intercom caller to busy department member hears busy) 1 = Circular (Intercom callers to busy department member routes to idle member)	0	16-02

Item No.	Item	Input Data	Default	Related Program
04	<p>Hunting Mode</p> <p>Set the action taken when a call reaches the last extension in the Department Group (0 = hunting stopped, 1 = hunting repeats with circular routing through the Department Group).</p>	<p>0 = Last extension is called and hunting is stopped</p> <p>1 = Circular</p>	0	
05	<p>Extension Group All Ring Mode Operation</p> <p>Determine whether calls ringing a Department Group should ring all extensions in the group simultaneously automatically or manually when using the service code defined in Program 11-12-09.</p> <p> <i>When set to (1) Automatic, only ICM Calls and DID Calls will ring all the stations in the Department Group.</i></p>	<p>0 = Manual</p> <p>1 = Automatic</p>	0	11-16-10
06	<p>STG Withdraw Mode</p>	<p>0 = Disable (Camp On)</p> <p>1 = Enable (Overflow Mode)</p>	0	
07	<p>Call Recall Restriction for STG</p> <p>Determine whether or not an unanswered call transferred to a Department Group should recall the extension from which it was transferred.</p>	<p>0 = Disable (Recall)</p> <p>1 = Enable (No Recall)</p>	0	
08	--- Not Used ---			
09	<p>Department Hunting No Answer Time</p> <p>Set the time a call rings a Department group extension before hunting occurs.</p>	0~64800 seconds	15	
10	<p>Enhanced Hunt Type</p> <p>Set the type of hunting for each Extension (Department) Group.</p>	<p>0 = No queuing</p> <p>1 = Hunting When Busy</p> <p>2 = Hunting When Not Answered</p> <p>3 = Hunting When Busy or No Answer</p>	0	

Conditions

None

Feature Cross Reference

- Department Calling

Program 16 : Department Group Setup

16-02 : Department Group Assignment for Extensions

Level:
IN

Description

Use **Program 16-02 : Department Group Assignment for Extensions** to set the Department Groups. The system uses these groups (64 Department Groups) for Department Calling. Assign pilot numbers to Department Groups you set up in Program 11-07. This lets system users place calls to the departments. Use Program 16-01 to set the priority of each extension in each Department Group. When a call comes to the group, the extensions ring in order of their priority.

Input Data

Extension Number	Maximum 8 digits
------------------	------------------

Item No.	Group Number	Priority	Default	Description	Related Program
01	1~64	1~999	1 – xxx (See Note)	Set up the Department Group called by the pilot number and the extension priority when a group is called. Call Pickup Groups are set up in 23-02.	11-07 16-01

 *The initial value of a priority becomes the ports numerical order assigned in Program 11-02 and 11-04. (Extension ports are 1~ 256. Virtual extension ports are 1~256.)*

Conditions

None

Feature Cross Reference

- Department Calling

Program 16 : Department Group Setup

16-03 : Secondary Department Group

Level:
IN

Description

Use **Program 16-03 : Secondary Department Group** to set a second Department Group for extensions. Up to 16 extensions can be assigned per Department Group. There are 64 available Department Groups.

Input Data

Department (Extension) Group Number	01~64
-------------------------------------	-------

Item No.	Secondary Extension Number	Extension Number	Priority Order	Description
01	1~16	Maximum 8 digits	0~999	This program is set up when placing telephones in two or more groups.

Default

- All extension groups : No setting

Conditions

None

Feature Cross Reference

- Department Calling

Program 16 : Department Group Setup

16-04 : Call Restriction Between Department Groups

Level:
IN

Description

Use **Program 16-04 : Call Restriction Between Department Groups** to set internal calls between members of different Department (Station) groups that can be restricted per group. Each department group can restrict calls to up to eight department groups in Department Group - Departmental Call Restriction.

Input Data

Extension (Department) Group Number	1~64
-------------------------------------	------

Restricted Group Index	1~8
------------------------	-----

Restrict Department Group Number	Description	Default
0~64	Calls between members of different Department (Station) groups can be restricted per group.	0

Conditions

None

Feature Cross Reference

None

Program 20 : System Option Setup

20-01 : System Options

Level:
IN

Description

Use **Program 20-01 : System Options** to set various system options.

Input Data

Item No.	Item	Input Data	Default	Description	Related Program
01	Operator Access Mode	0 = Step Call 1 = Circular	0	Set up priority of a call when calling an operator telephone.	20-17
02	Text Message Mode	0 = Call mode 1 = No Answer/ Busy mode	1	Select the mode when calling the telephone which set up the text message.	11-11-14 15-07-08
04	--- Not Used ---				
05	DTMF Receive Active Time	0~64800 seconds	10	For OPXs, analog telephones and certain analog trunks (like DISA), the system attaches a DTMF receiver to the port for this time. The system releases the receiver after the time expires.	25-07-01
06	Alarm Duration	0~64800 seconds	30	This time sets the duration of the alarm signal.	11-12-05
07	Callback Ring Duration Time	0~64800 seconds	15	Callback rings an extension for this time.	11-12-05 15-07-35
08	Trunk Queuing Callback Time	0~64800 seconds	15	Trunk Queuing callback rings an extension for this time.	11-12-05 15-07-35
09	Callback/Trunk Queuing Cancel Time	0~64800 seconds	64800	The system cancels an extension Callback or Trunk Queueing request after this time.	11-12-05 15-07-35
10	Trunk Guard Timer	0~64800 seconds	1	The time the system waits to seize the next outside line after the system releases an outside line.	
12	Telephone/Web Pro Logout Time	1~84600 seconds (84600 sec = 1 day)	900	The system automatically logs out of a Telephone/Web Pro session after inactivity lasting this time.	

Program

20

Conditions

None

Feature Cross Reference

- Refer to the Input Data table at the beginning of this section.

Program 20 : System Option Setup

20-02 : System Options for Multiline Telephones

Level:

IN

Description

Use **Program 20-02 : System Options for Multiline Telephones** to set various system options for multiline telephones.

Input Data

Item No.	Item	Input Data	Default	Related Programming
02	Trunk Group Access Key Operating Mode Set the operating mode of the extension trunk group keys. The keys are for incoming access, outgoing access, or both.	0 = Outgoing / Incoming 1 = Outgoing 2 = Incoming	0	
04	Retrieve the Line After Transfer Enable (1)/Disable (0) an extension ability to answer a call after it has been transferred, but before it is answered.	0 = Not Holding (No Keep) 1 = Holding (Keep)	1	
05	Headset Busy Mode Set the conditions under which a headset extension is busy to incoming callers.	0 = No (Disable) 1 = Yes (Enable)	0	20-09-07
06	Preselection Time When a multiline terminal user preselects a line key, the system remembers the preselection for this time.	0~64800 (sec)	5	
07	Time and Date Display Mode Set how the Time and Date appear on display telephones. There are eight display modes.	1~8 Type 1 = (12 hour) 10 MAR TUE 3:15PM Type 2 = (12 hour) 3:15PM MAR 10 TUE Type 3 = (12 hour) 3-10 TUE 3:15 PM Type 4 = (12 hour) 3:15PM TUE 10 MAR Type 5 = (24 hour) 10 MAR TUE 15:15 Type 6 = (24 hour) 15:15 MAR 10 TUE Type 7 = (24 hour) 3-10 TUE 15:15 Type 8 = (24 hour) 15:15 TUE 10 MAR	3	
08	LCD Display Holding Time	0~64800 (sec)	5	

Input Data (Continued)

Item No.	Item	Input Data	Default	Related Programming
09	Disconnect Supervision Enable/Disable disconnect supervision for the system trunks.	0 = Disable (Off) 1 = Enable (On)	1	
10	Time Before Shifting to Power-Saving Mode	0 = No shift 1 = 1 minute 2 = 2 minutes 3 = 4 minutes 4 = 8 minutes 5 = 16 minutes 6 = 32 minutes 7 = 64 minutes	0	15-02-18
11	Handsfree Microphone Control Control the setting for Multiline Terminal Handsfree microphone after being disconnected and reconnected. If set to 0, the microphone is always off when the terminal is reconnected. If set to 1, the microphone remains in the same state it was in when the terminal is reconnected.	0 = Off 1 = On	1	
12	Forced Intercom Ring (ICM Call Type) Enable/Disable Forced Intercom Ringing. If enabled, incoming Intercom calls normally ring. If disabled, Intercom calls voice-announce.	0 = Disable (Voice) 1 = Enable (Signal)	0	
13	--- Not Used ---			
15	Caller ID Display Mode	0 = Name and Number (Both) 1 = Name 2 = Number	0	
18	Dialing Record Display Time	0~64800 seconds	30	
19	Virtual Extension Mode Set the mode of a virtual extension key that appears on a DSS console.	0 = No 1 = Yes	0	

Conditions

None

Feature Cross Reference

None

Program 20 : System Option Setup

20-03 : System Options for Single Line Telephones

Level:
IN

Description

Use **Program 20-03 : System Options for Single Line Telephones** to set up various options for single line telephones.

Input Data

Item No.	Item	Input Data	Default	Related Program
01	<p>SLT Call Waiting Answer Mode</p> <p>For a busy single line (500/2500 type) telephone, set the mode used to answer a camped-on trunk call.</p>	<p>0 = Hookflash (Hooking)</p> <p>1 = Hookflash + Service Code 654</p>	0	11-12-47
02	<p>Ignore Received DP Dial on DTMF SLT Port</p> <p>Define whether the system should receive dial pulse and DTMF signals (0) or ignore dial pulse and only accept DTMF signals (1).</p>	<p>0 = Do Not Ignore (No)</p> <p>1 = Ignore (Yes)</p>	0	15-03-01
03	<p>SLT DTMF Dial to Trunk Lines</p> <ul style="list-style-type: none"> ○ Type 0: The system keeps the digits dialed by the single line telephone on a trunk in a buffer. After all the digits are received, the system sends all the digits to the trunk. If the time space between digits is longer than the time in Item 4, the system considers all digits received. ○ Type 1: The system passes the received digits from the single line telephone to the trunk immediately. If the single line telephone has a Last Number Dial key without a pause, this key may not be able to use the Last Number Dial key with the Type 1 setting. <p>When using a third-party external paging device, set this option to 1. In addition, set Program 20-03-04 to 1. These programs must be set for Wireless – DECT users to be able to break dial tone on an analog trunk that is used for paging.</p>	<p>0 = Receive all dialed data, before sending (All)</p> <p>1 = Direct through out (Direct)</p>	0	20-03-04

Input Data

Item No.	Item	Input Data	Default	Related Program
04	Dial Sending Start Time for SLT or ARS When ARS or an analog extension user accesses a trunk and dials an outside call, the system waits this time before outdialing the first digit. When using a third-party external paging device, set this option to 1 . In addition, set Program 20-03-03 to 1 .	0~64800 seconds	3	20-03-03
05	SLT Operation Mode	0 = Normal Mode 1 = Extended Mode 1 2 = Extended Mode 2	0	
06	Headset Ringing Start Time (for SLT) Define the headset ringing start time. After this time expires from the time when a single line telephone is off-hook, the system sets the single line telephone to headset ringing mode.	0~64800 seconds	5	20-13-38
07	Trunk Call Dial Forced Sending Start Time (Forced Dial)	0~64800 seconds	0	20-03-03 20-03-04

Conditions

None

Feature Cross Reference

- Single Line Telephones, Analog 500/2500 Sets

Program 20 : System Option Setup

20-04 : System Options for Virtual Extensions

Level:
IN

Description

Use **Program 20-04 : System Options for Virtual Extensions** to set up various system options for Virtual Extensions. There are 256 available virtual extension ports.

Input Data

Item No.	Item	Input Data	Default
03	CAR/SIE/Virtual Extension Delay Interval CAR Keys/SIE Keys/Virtual Extensions set for Delayed Ringing (see Program 15-11) ring the extension after this time.	0~64800 seconds	10
04	Virtual Extension Key Seize Mode Change the BLF status of a SIE key. When set to Enhanced , the BLF does not show as being busy when the station is on a trunk call. When set to Normal , the BLF shows as being busy when on a trunk call.	0 = Normal 1 = Enhanced Option	1

Conditions

None

Feature Cross Reference

- Call Arrival (CAR) Keys (CAR/Secondary Incoming Extensions/Virtual Extensions)

Program 20 : System Option Setup

20-06 : Class of Service for Extensions

Level:
IN

Description

Use **Program 20-06 : Class of Service for Extensions** to assign a Class of Service (COS) to an extension. There are 15 Classes of Service that can be assigned. To specify the options in each Class of Service, refer to Programs 20-07 through 20-13. You make eight entries for Program 20-06, one for each Night Service Mode.

Input Data

Extension Number	Maximum eight digits
------------------	----------------------

Item No.	Day/Night Mode	Class of Service for Extensions
01	1~8	1~15

Default

- Extension number 101 as Class 15.
- All other extension numbers are set as Class 1.

Conditions

None

Feature Cross Reference

- Class of Service

Program 20 : System Option Setup

20-07 : Class of Service Options (Administrator Level)

Level:
IN

Description

Use **Program 20-07 : Class of Service Options (Administrator Level)** to define the administrator service availability for each extension Class of Service (COS).

Input Data

Class of Service Number	01~15
-------------------------	-------

Item No.	Item	Input Data	Default		Related Program
			COS 1~14	COS 15	
01	Manual Night Service Enabled Turn off or on an extension for manual Night Service Switching.	0 = Off 1 = On	0	1	11-10-01
02	Changing the Music on Hold Tone Turn off or on an extension to change the Music on Hold tone.	0 = Off 1 = On	0	1	11-10-02
03	Time Setting Turn off or on an extension to set the Time via Service Code 728.	0 = Off 1 = On	1	1	11-10-03
04	Storing Speed Dialing Entries Turn off or on an extension to store System or Group Speed Dialing numbers.	0 = Off 1 = On	1	1	11-10-04
05	Set/Cancel Automatic Trunk-to-Trunk Transfer Turn off or on an extension user ability to use the Trunk-to-Trunk Forwarding service codes.	0 = Off 1 = On	0	0	11-10-06 11-10-07 11-10-08
06	--- Not Used ---				
07	--- Not Used ---				
08	--- Not Used ---				
09	--- Not Used ---				

Item No.	Item	Input Data	Default		Related Program
			COS 1~14	COS 15	
10	Programmable Function Key Programming (Appearance Level) Turn off or on an extension user ability to program the Appearance function keys using Service Code 752.	0 = Off 1 = On	1	1	11-11-38 20-13-18
11	Forced Trunk Disconnect (analog trunk only) Turn off or on an extension user ability to use Forced Trunk Disconnect.	0 = Off 1 = On	0	1	11-10-26
12	Trunk Port Disable	0 = Off 1 = On	0	1	11-10-27
13	VRS Record (VRS Msg Operation) Turn off or on an extension user ability to record, erase and listen to VRS messages.	0 = Off 1 = On	0	1	11-10-19
14	VRS General Message Play Turn an extension off or on to dial 4 or Service Code 611 to listen to the General Message.	0 = Off 1 = On	0	1	11-10-21
15	VRS General Message Record/Delete Turn off or on an extension user ability to dial Service Code 612 and record, listen to, or erase the General Message.	0 = Off 1 = On	0	1	11-10-22
18	SMDR Printout Accumulated Extension Data	0 = Off 1 = On	0	1	11-10-23
19	SMDR Printout Department Group (STG) Data	0 = Off 1 = On	0	1	11-10-24
20	SMDR Printout Accumulated Account Code Data	0 = Off 1 = On	0	1	11-10-25
21	Register and delete DECTPP	0 = Off 1 = On	0	0	
22	--- Not Used ---				
23	CO MSG Waiting Indication Callback Number Programming Enable/Disable an extension ability to receive CO Message Waiting Indication.	0 = Off 1 = On	0	0	
24	Set/Cancel Private Call Refuse Enable/Disable an extension user ability to set or cancel Private Call Refuse.	0 = Off 1 = On	0	0	11-10-32

Item No.	Item	Input Data	Default		Related Program
			COS 1~14	COS 15	
25	Set/Cancel Caller ID Refuse Enable/Disable an extension user ability to set or cancel Caller ID Refuse.	0 = Off 1 = On	0	0	11-10-33 11-10-34
26	Dial-In Mode Switch	0 = Off 1 = On	0	0	11-10-35
27	Do-Not-Call Administrator	0 = Off 1 = On	0	0	25-01-07 15-07-89 20-01-19
28	--- Not Used ---				
30	Date Setting	0 = Off 1 = On	1	1	11-10-41

Conditions

None

Feature Cross Reference

- Class of Service

Program 20 : System Option Setup

20-08 : Class of Service Options (Outgoing Call Service)

Level:

IN

Description

Use **Program 20-08 : Class of Service Options (Outgoing Call Service)** to define the outgoing call feature availability for each extension Class of Service (COS).

Input Data

Class of Service Number	01~15
-------------------------	-------

Item No.	Item	Input Data	Default		Related Program
			COS 01-14	COS 15	
01	Intercom Calls Turn off or on Intercom calling for the extension.	0 = Off 1 = On	1	1	
02	Trunk Outgoing Calls Turn off or on outgoing trunk calling for the extension.	0 = Off 1 = On	1	1	
03	System Speed Dialing Turn off or on an extension ability to make outbound calls using system speed dial numbers.	0 = Off 1 = On	1	1	
04	Group Speed Dialing Turn off or on an extension ability to make outbound calls using group speed dial numbers.	0 = Off 1 = On	1	1	
05	Dial Number Preview (Preset Dial) Turn off or on an extension ability to use Dial Number Preview.	0 = Off 1 = On	1	1	
06	Toll Restriction Override Turn off or on Toll Restricting Override (Service Code 663).	0 = Off 1 = On	0	0	11-11-36 21-01-07 21-07
07	Repeat Redial Turn off or on an extension ability to use Repeat Redial.	0 = Off 1 = On	1	1	

Item No.	Item	Input Data	Default		Related Program
			COS 01-14	COS 15	
08	Toll Restriction Dial Block Turn off or on an extension ability to use Dial Block.	0 = Off 1 = On	0	0	
09	Hotline/Extension Ringdown Turn off or on Ringdown Extension for extensions with this COS.	0 = Off 1 = On	0	0	
10	Signal/Voice Call Turn off or on an extension allowing it to force Handsfree Answerback or Forced Intercom Ringing for outgoing Intercom calls.	0 = Off 1 = On	1	1	
11	Protect for the Call Mode Switching from Caller (Internal Call)	0 = Off 1 = On	0	0	
12	Department Group Step Calling Turn off or on an extension ability to use Department Group Step Calling.	0 = Off 1 = On	1	1	
13	ISDN CLIP Determine if the ISDN calling line identity presentation and screening indicators are allowed.	0 = Off 1 = On	0	0	10-03-05 15-01-04
14	Call Address Information	0 = Off 1 = On	0	0	
15	Block Outgoing Caller ID Turn off or on the system ability to automatically block outgoing Caller ID information when a user places a call. If this option is on, the system automatically inserts the Caller ID block code (defined in Program 14-01-21) before the user-dialed digits.	0 = Off 1 = On	0	0	14-01-20 14-01-21
16	Display E911 Dialed Extension Name and Number Turn off or on an extension ability to display the name and number of the extension that dialed 911.	0 = Off 1 = On	0	0	
17	ARS Override of Trunk Access Map Turn off or on an extension user ability to override the trunk access map programming for outgoing calls.	0 = Off 1 = On	0	0	
19	Hotline for SPK Set the ability of an extension to have Hotline activated or deactivated when going off hook via the speaker key.	0 = Off 1 = On	0	0	20-08-09

Item No.	Item	Input Data	Default		Related Program
			COS 01-14	COS 15	
20	Hot Key Pad Set The ability of an extension user to make a call by dialing the number without first going off hook.	0 = Off 1 = On	0	0	
21	Automatic Trunk Seizing by Pressing SPK Key Turn off or on an extension user ability to automatically access Trunk Route when going off hook via the speaker key.	0 = Off 1 = On	0	0	
22	Voice Over to Busy Virtual Extension Turn off or on an extension user ability to make Voice Over to Busy Virtual Extension.	0 = Off 1 = On	0	0	

Conditions

None

Feature Cross Reference

- Class of Service

Program 20 : System Option Setup

20-09 : Class of Service Options (Incoming Call Service)

Level:

IN

Description

Use **Program 20-09 : Class of Service Options (Incoming Call Service)** to define the incoming call feature availability for each extension Class of Service (COS).

Input Data

Class of Service Number	01~15
-------------------------	-------

Item No.	Item	Input Data	Default		Related Program
			COS 01~14	COS 15	
01	Second Call for DID/DISA/DIL/E&M Override Turn off or on the extension ability to receive a second call from a DID, DISA, DIL, or tie line caller. <i>With this option set to 1, the destination extension must be busy for a second DNIS caller to ring through. If the destination extension does not have a trunk or CAP key available for the second call and a previous call is ringing the extension but has not yet been answered, the second caller hears busy regardless of this program setting.</i>	0 = Off 1 = On	1	1	
02	Caller ID Display Turn off or on the Caller ID display at an extension.	0 = Off 1 = On	0	0	15-02-08
03	Sub Address Identification Define whether or not an extension displays the Caller Sub-Address.	0 = Off 1 = On	0	0	
04	Notification for Incoming Call List Existence Determine whether or not an extension display shows Check List when an incoming call is missed by a user.	0 = Off 1 = On	0	0	20-09-02

Item No.	Item	Input Data	Default		Related Program
			COS 01~14	COS 15	
05	Signal/Voice Call Turn off or on an extension user ability to enable Handsfree Answerback or Forced Intercom Ringing for their incoming Intercom calls.	0 = Off 1 = On	1	1	11-11-15, 11-11-16
06	Incoming Time Display	0 = Off 1 = On	0	0	
07	Call Queuing Turn off or on an extension user ability to have calls queued if a call rings the extension when it is busy.	0 = Off 1 = On	1	1	20-13-06
08	Calling Party Information Turn off or on an extension ability to display calling party information on CCIS calls.	0 = Off 1 = On	1	1	50-02-05

Conditions

None

Feature Cross Reference

- Class of Service

Program 20 : System Option Setup

20-10 : Class of Service Options (Answer Service)

Level:
IN

Description

Use **Program 20-10 : Class of Service Options (Answer Service)** to define the answer feature availability for each extension Class of Service (COS).

Class of Service Number	01~15
-------------------------	-------

Item No.	Item	Input Data	Default	
			COS 01~14	COS 15
01	Group Call Pickup (Within Group) Turn off or on Group Call Pickup for calls ringing an extension Pickup Group and ringing group calls (Service Code 756).	0 = Off 1 = On	1	1
02	Group Call Pickup (Another Group) Turn off or on Group Call Pickup for calls ringing outside a group (Service Code 769).	0 = Off 1 = On	1	1
03	Group Call Pickup for Specific Group Turn off or on Group Call Pickup for a specific group (Service Code 768).	0 = Off 1 = On	1	1
04	Telephone Call Pickup Turn off or on an extension ability to pick up a call ringing into a Pickup Group (Service Code * #).	0 = Off 1 = On	1	1
05	Directed Call Pickup for Own Group Turn off or on Directed Call Pickup for calls ringing an extension Pickup Group (Service Code 756).	0 = Off 1 = On	1	1
06	Meet-Me Conference and Paging Turn off or on an extension user ability to use Meet-Me Conference and Paging.	0 = Off 1 = On	1	1
07	Automatic Off-Hook Answer Turn off or on an extension user ability to use Universal Auto Answer (no service code required).	0 = Off 1 = On	0	0

Item No.	Item	Input Data	Default	
			COS 01~14	COS 15
08	Virtual Extension Off-Hook Answer Turn off or on an extension ability to answer an incoming call on a Call Arrival (CAR)/Secondary Incoming Extension (SIE)/Virtual Extension simply by lifting the handset.	0 = Off 1 = On	1	1
09	Call Pickup Callback Turn off or on an extension user ability to use Call Pickup to pick up Callback calls.	0 = Off 1 = On	1	1
10	Answer Preset	0 = Off 1 = On	0	0

Conditions

None

Feature Cross Reference

None

Program 20 : System Option Setup

20-11 : Class of Service Options (Hold/Transfer Service)

Level:
IN

Description

Use **Program 20-11 : Class of Service Options (Hold/Transfer Service)** to define the Hold and Transfer feature availability for each extension Class of Service (COS).

Input Data

Class of Service Number	01~15
-------------------------	-------

Item No.	Item	Input Data	Default	
			COS 01~14	COS 15
01	Call Forward All Turn off or on an extension user ability to initiate Call Forwarding All.	0 = Off 1 = On	1	1
02	Call Forward When Busy Turn off or on an extension user ability to use Call Forward when Busy.	0 = Off 1 = On	1	1
03	Call Forwarding When Unanswered Turn off or on an extension user ability to use Call Forward when Unanswered.	0 = Off 1 = On	1	1
04	Call Forwarding (Both Ringing) Turn off or on an extension user ability to activate Call Forwarding with Both Ringing.	0 = Off 1 = On	1	1
05	Call Forwarding with Follow Me Turn off or on an extension user ability to initiate Call Forwarding with Follow Me.	0 = Off 1 = On	1	1
06	Unscreened Transfer (Ring Inward Transfer) Turn off or on an extension user ability to use Unscreened Transfer.	0 = Off 1 = On	1	1
07	Transfer Without Holding Turn off or on an extension user ability to use Transfer Without Holding.	0 = Off 1 = On	0	0

Item No.	Item	Input Data	Default	
			COS 01~14	COS 15
08	Transfer Information Display Turn off or on an extension ability for incoming Transfer preanswer display.	0 = Off 1 = On	1	1
09	Group Hold Initiate Turn off or on an extension user ability to initiate a Group Hold.	0 = Off 1 = On	1	1
10	Group Hold Answer Turn off or on an extension user ability to pick up a call on Group Hold.	0 = Off 1 = On	1	1
11	Automatic On-Hook Transfer Turn off or on an extension user ability to use Automatic On Hook Transfer.	0 = Off 1 = On	0	0
12	Call Forwarding Off Premise (External Call Forwarding) Turn off or on an extension user ability to set up Call Forwarding Off-Premise for their telephone.	0 = Off 1 = On	0	0
13	Operator Transfer After Hold Callback Turn off or on an extension user ability to have a call which recalls from hold transfer to the operator.	0 = Off 1 = On	0	0
14	Trunk-to-Trunk Transfer Restriction Turn off or on the Trunk-to-Trunk Transfer Restriction. If enabled, Trunk-to-Trunk Transfer is not possible.	0 = Off 1 = On	0	0
15	VRS Personal Greeting (Message Greeting) Turn off or on an extension user ability to record, listen to, or erase the Personal Greeting Message.	0 = Off 1 = On	1	1
16	Call Redirect Turn off or on a multiline terminal user ability to transfer a call to a predefined destination (such as an operator, voice mail, or another extension) without answering the call.	0 = Off 1 = On	1	1
17	Department Group Trunk-to-Trunk Transfer (Each Telephone Group Transfer) Turn off or on an extension user ability to set Trunk-to-Trunk Forwarding for a Department Group.	0 = Off 1 = On	1	1
18	No Recall No Recall set to 1 does not stop transferred calls from recalling from a virtual extension.	0 = Off 1 = On	0	0
19	Hold/Extended Park Determine if an extension Class of Service should allow either a normal or extended Park.	0 = Off 1 = On	0	0

Item No.	Item	Input Data	Default	
			COS 01~14	COS 15
20	No Callback Turn off or on an extension ability to receive callbacks.	0 = Off 1 = On	0	0
21	Restriction for Tandem Trunking on Hang Up Allow/Deny an extension user ability to set up a tandem/conference call automatically when they hang up.	0 = Off 1 = On	0	0
22	Restricted Unsupervised Conference Allow/Deny an extension user ability to initiate an unsupervised conference.	0 = Off 1 = On	0	0
23	CAR/VE Call Forward Set/Cancel Turn Off or on an extension user ability to set or cancel call forwarding for a virtual extension.	0 = Off 1 = On	1	1
24	Trunk Park Hold Mode Set the hold type when a trunk call is put on hold by an extension.	0 = Non Exclusive Hold (Off) 1 = Exclusive Hold (On)	1	1
25	Transfer Park Call Turn off or on an extension user ability to transfer a parked call.	0 = Off 1 = On	1	1
27	Call Park Automatically Search	0 = Off 1 = On	1	1

Conditions

None

Feature Cross Reference

- Class of Service

Program 20 : System Option Setup

20-12 : Class of Service Options (Charging Cost Service)

Level:

IN

Description

Use **Program 20-12 : Class of Service Options (Charging Cost Service)** to define the Charging Cost service availability for each extension service class.

Input Data

Class of Service Number	01~15
-------------------------	-------

Item No.	Item	Input Data	Default	
			COS 01~14	COS 15
02	Advice of Charge ISDN-AOC	0 = Off 1 = On	0	0
03	Cost Display (TTU)	0 = Off 1 = On	1	1

Conditions

None

Feature Cross Reference

- Class of Service

Program 20 : System Option Setup

20-13 : Class of Service Options (Supplementary Service)

Level:
IN

Description

Use **Program 20-13 : Class of Service Options (Supplementary Service)** to define the supplementary feature availability for each extension Class of Service (COS).

Input Data

Class of Service Number	01~15
-------------------------	-------

Item No.	Item	Input Data	Default		Related Programming
			COS 01~14	COS 15	
01	Long Conversation Alarm Turn off or on the Warning Tone for Long Conversation (not for single line telephones).	0 = Off 1 = On	0	0	
02	Long Conversation Cutoff (Incoming) Turn off or on an extension user ability to use Long Conversation Cutoff for incoming calls.	0 = Off 1 = On	0	0	
03	Long Conversation Cutoff (Outgoing) Turn off or on an extension user ability to use Long Conversation Cutoff for outgoing calls.	0 = Off 1 = On	0	0	
04	Call Forward/DND Override (Bypass Call) Turn off or on an extension user ability to use Call Forwarding/DND Override.	0 = Off 1 = On	1	1	
05	Intercom Off-Hook Signaling Turn off or on an extension ability to receive off-hook signals.	0 = Off 1 = On	1	1	
06	Automatic Off-Hook Signaling (Automatic Override) Allow a busy extension ability to manually (0) or automatically (1) receive off-hook signals.	0 = Off 1 = On	1	1	
07	Message Waiting Turn off or on an extension user ability to leave Message Waiting.	0 = Off 1 = On	1	1	

Item No.	Item	Input Data	Default		Related Programming
			COS 01~14	COS 15	
08	Conference Turn off or on an extension user ability to initiate a conference or Meet-Me Conference.	0 = Off 1 = On	1	1	
09	Privacy Release Turn off or on an extension user ability to initiate a Voice Call Conference.	0 = Off 1 = On	1	1	
10	Barge-In Monitor Enable the extension Barge-In Mode to be Speech or Monitor.	0 = Speech 1 = Monitor	0	0	20-13-45
11	Room Monitor, Initiating Extension Turn off or on an extension user ability to Room Monitor other extensions.	0 = Off 1 = On	0	0	
12	Room Monitor, Extension Being Monitored Turn off or on an extension ability to be monitored by other extensions.	0 = Off 1 = On	0	0	
13	Continued Dialing (DTMF) Signal on ICM Call Turn off or on an extension user ability to use Continued Dialing, which allows DTMF signal sending while talking on extension.	0 = Off 1 = On	1	1	
14	Department Calling (PLT No Called Extension) Turn off or on an extension user ability to call a Department Group Pilot.	0 = Off 1 = On	1	1	
15	Barge-In, Initiate Turn off or on an extension user ability to barge-in on other's calls.	0 = Off 1 = On	0	0	
16	Barge-In, Receive Turn off or on an extension user ability to have other extensions barge-in on calls.	0 = Off 1 = On	0	0	
17	Barge-in Tone/Display (Intrusion Tone) Turn off or on the Barge-In tone. If on, callers hear an alert tone and their display indicates the Barge-In when another extension barges into their conversation. If off, there is no alert tone or display indication.	0 = Off 1 = On	1	1	
18	Programmable Function Key Programming (General Level) Turn off or on an extension user ability to program General function keys using Service Code 751 (by default). (Refer to Program 20-07-10 for Service Code 752.)	0 = Off 1 = On	1	1	

Item No.	Item	Input Data	Default		Related Programming
			COS 01~14	COS 15	
19	Selectable Display Messaging (Text Messaging) Turn off or on an extension user ability to use Selectable Display Messaging.	0 = Off 1 = On	1	1	
20	Account Code/Toll Restriction Operator Alert (Restricted Operation Transfer) Turn off or on operator alert when an extension user improperly enters an Account Code or violates Toll Restriction.	0 = Off 1 = On	0	0	
21	Extension Name Turn off or on an extension user ability to program its name.	0 = Off 1 = On	1	1	
22	Busy Status Display (Called Party Status) Turn off or on the ability to display the detailed state of the called party.	0 = Off 1 = On	0	0	20-13-06
23	Display the Reason for Transfer Select whether or not an extension should display the reason a call is being transferred to their extension (Call Forward Busy, Call Forward No Answer, DND).	0 = Off 1 = On	0	0	
24	Privacy Release by Pressing Line Key Turn off or on a user ability to press a line key to barge into an outside call. The Barge-In feature must be enabled if this option is used.	0 = Off 1 = On	0	0	
25	--- Not Used ---				
26	Group Listen Turn off or on an extension user ability to use Group Listen.	0 = Off 1 = On	1	1	
27	Busy on Seizing Virtual Extension If set to 1, you can call a busy extension which is talking on a virtual extension key. Program 20-13-06 (Call Waiting) must be set to 0 for this option to work.	0 = Off 1 = On	1	1	
28	Allow Class of Service to be Changed Turn off or on the ability of an extension Class of Service to be changed via Service Code 677.	0 = Off 1 = On	0	0	
29	Paging Display Turn off or on an extension user ability to display paging information.	0 = Off 1 = On	1	1	
30	Background Music Allow/Deny an extension user to turn Background Music on and off.	0 = Deny 1 = Allow	1	1	

Item No.	Item	Input Data	Default		Related Programming
			COS 01~14	COS 15	
31	Connected Line Identification (COLP)	0 = Off 1 = On	0	0	
32	Deny Multiple Barge-Ins Allow/Deny an extension user from having multiple users Barge into their conversation.	0 = Off 1 = On	0	0	
33	ACD Supervisor's Position Enhancement This option must be set to 1 for the operator to use service codes in Program 11-13-10 ~ 11-13-13.	0 = Off 1 = On	0	0	11-13-10 11-13-11 11-13-12 11-13-13
34	Block Manual Off-Hook Signaling Turn off or on an extension user ability to block off-hook signals manually sent from a co-worker.	0 = Off 1 = On	0	0	
35	Block Camp On Turn off or on an extension user ability to block callers from dialing to Camp On.	0 = Off 1 = On	0	0	
36	Call Duration Timer Display Turn off or on an extension display of the Call Duration Time. The system waits until the interdigit time (Program 21-01-01) expires before beginning this timer.	0 = Off 1 = On	1	1	
37	--- Not Used ---				
38	Headset Ringing for SLT Turn off or on an extension user ability to use the Headset ringing.	0 = Off 1 = On	0	0	
39	ACD Queue Status Display Turn off or on the ACD Queue Status Display for an extension Class of Service. Any extension which has this option enabled also receives the queue alarm.	0 = Off 1 = On	0	0	
40	Do Not Disturb Turn off or on an extension user ability to set or cancel Do Not Disturb.	0 = Off 1 = On	1	1	11-11-08 15-07-03
41	Voice Mail Message Indication on DSS Turn off or on the Voice Mail Message Indication for an extension on a DSS console.	0 = Off 1 = On	0	0	
42	Extension Data Swap Enabling Turn off or on an extension user ability to use Extension Data Swap.	0 = Off 1 = On	1	1	11-15-12
43	--- Not Used ---				

Item No.	Item	Input Data	Default		Related Programming
			COS 01~14	COS 15	
44	Live Monitor Enabling Turn off or on an extension user ability to use Live Monitor.	0 = Off 1 = On	1	1	
45	MIC Key Mode while Call Monitoring Set per class of service, when in Call Monitoring Mode determines if the monitored parties receive the barge in alert tone when Coaching Mode is enabled.	0 = Enable (Off) 1 = Disable (On)	1	1	20-13-10
47	Station Number Display Determine if a station Number is displayed (1) or not displayed (0) in the LCD when the phone is idle.	0 = Off 1 = On	1	1	
48	Station Name Display Determine if a station Name is displayed (1) or not displayed (0) in the LCD when the phone is idle.	0 = Off 1 = On	1	1	
49	BLF Indication on CO Incoming State Determine if a BLF of the station lights when a Normal CO call is ringing the phone.	0 = Off 1 = On	0	0	
50	AIC Agent display which call is from Determine if the station logged in via AIC code shows which queue the call is coming from.	0 = Off 1 = On	1	1	
51	Number and Name Appear in the Directory Determine if an extension name and number are listed (1) or unlisted (0) in the directory.	0 = Off 1 = On	1	1	
52	VoIP All DSP Busy Display Set whether "All DSP Busy" alarm displays on LCD when the caller makes an IP call and there is no VoIP DSP resource.	0 = Disable 1 = Enable	1	1	

Conditions

None

Feature Cross Reference

- Class of Service

Program 20 : System Option Setup

20-14 : Class of Service Options for DISA/E&M

Level:
IN

Description

Use **Program 20-14 : Class of Service Options for DISA/E&M** to enable/disable DISA and tie line Class of Service options. You assign a DISA Class of Service to DISA users in Program 25-09. Assign tie line Classes of Service in 34-02. Up to 15 DISA/E&M Classes of Service can be defined.

 **Analog trunk-to-analog trunk and ISDN trunk-to-ISDN trunk calls are supported by this program. However, analog trunk-to-ISDN trunk and ISDN trunk-to-analog trunk calls are NOT supported by this program.**

Input Data

Class of Service Number	01~15
-------------------------	-------

Item No.	Item	Input Data	Default
			COS 1~15
01	First Digit Absorbtion (Delete First Digit Dialed) For tie lines, enable/disable the ability to absorb (ignore) the first incoming digit. Use this to make the tie trunk compatible with 3- and 4-digit tie line service. This option does not apply to DISA.	0 = Off 1 = On	0
02	Trunk Group Routing/ARS Access Enable/Disable a DISA or tie trunk caller ability to dial 9 for Trunk Group Routing or Automatic Route Selection (ARS).	0 = Off 1 = On	1
03	Trunk Group Access Enable/Disable a DISA or tie trunk caller ability to access trunk groups for outside calls (Service Code 704).	0 = Off 1 = On	1
04	Outgoing System Speed Dial Enable/Disable a DISA or tie trunk caller ability to use the System Speed Dialing.	0 = Off 1 = On	0
05	Operator Calling Enable/Disable a DISA or tie trunk caller ability to dial 0 for the telephone system operator.	0 = Off 1 = On	1
06	Internal Paging Enable/Disable a DISA or tie trunk caller ability to use the telephone system Internal Paging.	0 = Off 1 = On	1

Item No.	Item	Input Data	Default
			COS 1~15
07	External Paging Enable/Disable a DISA or tie trunk caller ability to use the telephone system External Paging.	0 = Off 1 = On	1
08	Direct Trunk Access Enable/Disable a DISA or tie trunk caller ability to use Direct Trunk Access (Service Code #9).	0 = Off 1 = On	0
09	Forced Trunk Disconnect <Not for ISDN T-point> Enable/Disable a tie trunk caller ability to use Forced Trunk Disconnect (Service Code *3). This option is not available to DISA callers.	0 = Off 1 = On	0
10	Call Forward Setting by Remote via DISA Enable/Disable a DISA caller ability to use the Call Forward service codes (Programs 11-11-01 ~ 11-11-05).	0 = Off 1 = On	0
11	DISA/Tie Trunk Barge-In Enable/Disable a DISA or tie trunk caller ability to use Barge-In.	0 = Off 1 = On	0
12	Retrieve Park Hold Enable/Disable a DISA or tie trunk caller ability to retrieve a Park Hold call.	0 = Off 1 = On	1

Conditions

None

Feature Cross Reference

- Class of Service
- Direct Inward System Access (DISA)
- Tie Lines

Program 20 : System Option Setup

20-15 : Ring Cycle Setup

Level:
IN

Description

Use **Program 20-15 : Ring Cycle Setup** to define the ringing cycles for each ring type.

Input Data

Item No.	Incoming Signal Type	Ringing Cycle	Default
01	Normal Incoming Call on Trunk	1~13	2
02	PBX, CES Incoming Call		8
03	Incoming Internal Call		12
04	DID/DISA/VRS		8
05	DID/DDI		8
06	Dial-In in the E&M Tie Line		12
07	Door Box Ringing for SLT		8
08	Virtual Extension Ring		8
09	Callback		11
10	Alarm for SLT		5
11	VRS Waiting Message Incoming Call		6

Table 2-7 Ringing Cycles

Number	Ringing Cycle
1	On
2	On:2.0 / Off:4.0
3	On:1.0 / Off:2.0
4	On:0.5 / Off:0.5
5	On:0.25 / Off:0.25
6	On:0.5 / Off:0.5 / On:0.5 / Off:1.5
7	On:0.25 / Off:0.25 / On:0.25 / Off:5.25
8	On:0.375 / Off:0.25 / On:0.375 / Off:2.0
9	On:0.25 / Off:0.125 / On:0.25 / Off:0.125 / On:0.25 / Off:2.0
10	On:1.0 / Off:4.0
11	On:0.25 / Off:0.25 / On:0.25 / Off:4.25
12	On:1.0 / Off:3.0
13	On:0.25 / Off:0.25 / On:0.25 / Off:2.25

Conditions

None

Feature Cross Reference

None

Program 20 : System Option Setup

20-16 : Selectable Display Messages

Level:
SA

Description

Use **Program 20-16 : Selectable Display Messages** to enter the Selectable Display Messages. There are 20 alphanumeric messages, with up to 24 characters. Use the following chart when programming messages.

Use this keypad digit . . .	When you want to . . .
1	Enter characters: 1 @ [¥] ^ _ ` { } → ← Á À Â Ã Ç É Ê ì ó
2	Enter characters: A-C, a-c, 2.
3	Enter characters: D-F, d-f, 3.
4	Enter characters: G-I, g-i, 4.
5	Enter characters: J-L, j-l, 5.
6	Enter characters: M-O, m-o, 6.
7	Enter characters: P-S, p-s, 7.
8	Enter characters: T-V, t-v, 8.
9	Enter characters: W-Z, w-z, 9.
0	Enter characters: 0 ! “ # \$ % & ’ () ô õ ú ä ö ü α ε θ
*	Enter characters: * + , - . / : ; < = > ? π Σ σ Ω □ φ £
#	# = Accepts an entry (only required if two letters on the same key are needed – ex: TOM). Pressing # again = Space. (In system programming mode, use the right arrow soft key instead to accept and/or add a space.)
CONF	Clear the character entry one character at a time.
HOLD	Clear all the entries from the point of the flashing cursor and to the right.

When using DTP or DTU style telephones on the UNIVERGE SV8100 system, not all the same characters are available.

Input Data

Selectable Display Message Number	01~20
-----------------------------------	-------

Item No.	Input Data
01	24 characters

Default

Number	Message
1	IN MEETING UNTIL ##:##
2	MEETING ROOM – #####
3	COME BACK ##:##
4	PLEASE CALL #####
5	BUSY CALL AFTER ##:##
6	OUT FOR LUNCH BACK ##:##
7	BUSINESS TRIP BACK ####
8	BUSINESS TRIP #####
9	GONE FOR THE DAY
10	ON VACATION UNTIL ####
11	MESSAGE 11
12	MESSAGE 12
13	MESSAGE 13
14	MESSAGE 14
15	MESSAGE 15
16	MESSAGE 16
17	MESSAGE 17
18	MESSAGE 18
19	MESSAGE 19
20	MESSAGE 20

Conditions

- Time value **## : ##** must be followed by two spaces.

Feature Cross Reference

- Selectable Display Messages

Program 20 : System Option Setup

20-17 : Operator Extension

Level:
IN

Description

Use Program **20-17 : Operator Extension** to designate an operator. When an extension user dials 0 or 9 (defined by Program 11-01 Type 5), calls go to the operator selected in this program.

If you do not assign an extension in Program 90-11-01, system alarms appear on the extension assigned in this option.

Input Data

Operator Number	1~8
-----------------	-----

Item No.	Item	Input Data	Default	Related Program
01	Operator's Extension Number Define the extension numbers to be used by operators.	Up to eight digits	101	11-01 20-01-01

Conditions

None

Feature Cross Reference

- Intercom

Program 20 : System Option Setup

20-18 : Service Tone Timers

Level:
IN

Description

Use **Program 20-18 : Service Tone Timers** to set the values for the system service tone timers. Refer to the following chart for a description of each option, its range and default setting.

Input Data

Item No.	Item	Input Data	Default	Description	Related Program
01	Extension Dial Tone Time	0~64800 seconds	30	After getting Intercom dial tone, a telephone user has this time to dial the first digit of the Intercom call.	
02	Busy Tone Timer	0~64800 seconds	15		
03	Congestion Tone	0~64800 seconds	10	A Busy Tone when system resources run short. (such as DTMF receiver resources).	
04	Call Waiting Tone Timer	0~64800 seconds	10	Sets the time between Call Waiting tones. This timer also sets the time between Off-Hook Signaling alerts.	
05	Multiline Confirmation Tone	0~64800 seconds	10		
06	Interval of Call Waiting Tone	3~64800 seconds	10		
07	Intrusion Tone Repeat Time	0~64800 seconds	0	After a call is interrupted (such as Barge-In, Voice Mail Conversation Recording, or Voice Over), the system repeats the Intrusion Tone after this time. Normally, you should enter 0 to disable this time.	
08	Conference Tone Interval	0~64800 seconds	0		
09	Warning Beep Tone Signaling Interval	0~64800 seconds	60		14-01-18

Conditions

None

Feature Cross Reference

- Distinctive Ringing, Tones, and Flash Patterns

Program 20 : System Option Setup

20-19 : System Options for Caller ID

Level:
IN

Description

Use **Program 20-19 : System Options for Caller ID** to define the system options for the Caller ID feature.

Input Data

Item No.	Item	Input Data	Default
01	Caller ID Displaying Format (if displaying digits are more than 12 digits)	0 = First 10 digits (Upper) 1 = Last 10 digits (Lower)	0
02	--- Not Used ---		
04	Wait Facility IE Timer This timer is used with ISDN trunks to determine the time the system waits for the Caller ID name from the Telco.	0~64800 seconds	10
05	Caller ID Sender Queing Time (Sender Wait)	0~64800 seconds	0
07	Long Distance Code	Up to two digits	1
08	Area Code	Up to six digits	No setting
09	Calling Party Name for ISDN Trunk When set, sends the Calling Party Name to the network.	Up to 12 characters	No setting

Conditions

- Edit Caller ID works when Program 20-19-07 and Program 20-19-08 are set.
- Calling Party Name for ISDN Trunk works when Program 14-01-24 and Program 15-01-01 are set.

Feature Cross Reference

- Caller ID

Program 20 : System Option Setup

20-20 : Message Setup for Non-Caller ID Data

Level:
IN

Description

Use **Program 20-20 : Message Setup for Non-Caller ID Data** to define the messages which are displayed when no Caller ID information is received.

Input Data

Item No.	Item	Input Data	Default
01	Private Call	24 Alphanumeric Characters	PRIVATE
02	Call from Out of Service Area	24 Alphanumeric Characters	OUT OF AREA
03	Call Information with Error	24 Alphanumeric Characters	NO CALLER INFO

Conditions

None

Feature Cross Reference

- Caller ID

Program 20 : System Option Setup

20-21 : System Options for Long Conversation

Level:

IN

Description

Use **Program 20-21 : System Options for Long Conversation** to define the system options for the Long Conversation feature.

Input Data

Item No.	Item	Input Data	Default	Related Program
01	Long Conversation Alarm 1 The warning tone for long toll calls sounds after this time.	0~64800 (sec)	170	14-01-15
02	Long Conversation Alarm 2 After the initial long toll call warning tone, additional warning tones sound after this time.	0~64800 (sec)	180	14-01-15
03	Long Conversation Cutoff for Incoming Call This determines the time the system waits before disconnecting an incoming call.	0~64800 (sec)	0	14-01-14
04	Long Conversation Cutoff for Outgoing Call This determines the time the system waits before disconnecting an outgoing call.	0~64800 (sec)	0	14-01-14

Conditions

None

Feature Cross Reference

- Long Conversation Cutoff

Program 20 : System Option Setup

20-22 : System Options for Wireless – DECT Service

Level:
IN

Description

Use **Program 20-22 : System Options for Wireless – DECT Service** to define the time the system waits before determining the Wireless – DECT phone is out of range. For incoming calls, the time begins when the call is received. If the time defined here expires before the Wireless – DECT phone starts to ring, the system determines the phone is out of range and provides the out-of-range services (indicates out-of range, transfers the call to voice mail or to another extension).

Input Data

Item No.	Item	Input Data	Default
05	--- Not Used ---		
06	Out of Area Talkie Number	0~100	0

Conditions

None

Feature Cross Reference

- Wireless – DECT

Program 20 : System Option Setup

20-23 : System Options for CTI

Level:
IN

Description

Use **Program 20-23 : System Options for CTI** to define the system options for the CTI feature.

Input Data

Item No.	Item	Input Data	Default
01	Delayed ring timer for CTI	0~64800 (sec)	30
02	ALERT replay time (CTI)	0~64800 (sec)	8
03	Trunk Virtual Bridge – TSP Driver Enable/Disable the system to send trunk or virtual extension information to the TSP driver.	0 = Disable (No) 1 = Enable (Yes)	0
04	The Timer that waits for an off-hook for Single Line Telephone	0~64800 (sec)	30

Conditions

None

Feature Cross Reference

- Computer Telephony Integration (CTI) Applications

Program 20 : System Option Setup

20-25 : ISDN Options

Level:
IN

Description

Use **Program 20-25 : ISDN Options** to define the ISDN system options.

Input Data

Item No.	Item	Input Data	Default
01	Send the Release Message After Subscriber Hangs Up	0 = Service Off 1 = Service On	1
02	Progress Indicate Information Element Detect	0 = Service Off 1 = Service On	1
03	Bearer Capability Select from SLT Outgoing	0 = 3.1KHz Audio 1 = Speech	0
04	Send DT until user dials first digit (Local Dial Tone) With Overlap Sending Mode, if the network side stops dial tone when CLI is included in the SETUP message, the system sends dial tone until the user dials the first digit instead of the network.	0 = Service Off 1 = Service On	0
05	T305 Timer Start After Sending Disconnect Message	0 = Service Off 1 = Service On	1
06	Call Proceeding Send Mode	0 = Service Off 1 = Service On	1
07	Local Busy Tone Mode Set When Disconnect Message Received	0 = Local Busy Tone Off 1 = Busy Tone from NT (network side)	0
08	Use of Lower Layer Compatibility (LLC) This Program must be set to 0 for International Dialing when using Calling Number Presentation (CPN) from station.	0 = Disable (Off) 1 = Enable (On)	0
09	High Layer Compatibility (HLC) Sending	0 = Disable (Off) 1 = Enable (On)	0
10	S-Point Terminal Seizes Analog Trunk	0 = Disable (Off) 1 = Enable (On)	1

Input Data

Item No.	Item	Input Data	Default
11	Automatic Changing System Clock When Date/ Time Information Element Received	0 = Disable (Off) 1 = Enable (On)	0
12	Call Forward Options (Auto Connect Send) Incoming Calls Forwarded Out Automatically Return Connect Message When Outgoing Call Receives Alerting Message.	0 = Normal – No Message (Off) 1 = Normal – No Message (On)	0
13	Local Busy Tone (Release) Busy tone send when T-point receiving a RELEASE message from Network.	0 = Off 1 = On	0
14	No Response Release Send Operation mode setting for when second T303 timer expires.	0 = Off 1 = On	0

Conditions

None

Feature Cross Reference

- ISDN Compatibility

Program 20 : System Option Setup

20-26 : Multiplier Changing CO

Level:
IN

Description

Use **Program 20-26 : Multiplier Changing CO** to define the Multiplier for charging cost to each extension service class.

Input Data

Service Class	1~15
---------------	------

Item No.	Item	Input Data	Default
01	Value %	100~500	100

Conditions

None

Feature Cross Reference

None

Program 20 : System Option Setup

20-28 : Trunk to Trunk Conversation

Level:

IN

Description

Use **Program 20-28 : Trunk to Trunk Conversation** to define system options for Trunk to Trunk Conversation.

Input Data

Item No.	Item	Input Data	Default	Related Programming
01	Conversation Continue Code Input the code that can be dialed to continue the conversation after the Trunk-to-Trunk Release Warning Tone is heard.	0~9, #, * (Set for one digit only)	No Setting	14-01-25 20-28-03 24-02-07 24-02-10 25-07-07 25-07-08
02	Conversation Disconnect Code Input the code that can be dialed to disconnect the conversation after the Trunk-to-Trunk Release Warning Tone is heard.	0~9, #, * (Set for one digit only)	No Setting	14-01-25 24-02-07 24-02-10 25-07-07 25-07-08
03	Conversation Continue Time Input the time the conversation extends when the Conversation Continue Code is dialed.	0~64800 seconds	0	14-01-25 20-28-01 24-02-07 24-02-10 25-07-07 25-07-08

Conditions

None

Feature Cross Reference

None

Program 20 : System Option Setup

20-29 : Timer Class for Extension

Level:
IN

Description

Use **Program 20-29 : Timer Class for Extension** to assign the timer class to each extension. There are 16 Classes that can be assigned. You make eight entries for this Program, one for each Night Service Mode. This entry includes virtual extension numbers.

The details of classes are assigned by Program 20-31.

Input Data

Extension Number		Up to eight digits	
Item No.	Item	Input Data	Default
01	Day/Night Mode 1~8, Class Number	0~15 0 = Not assigned	0

Conditions

None

Feature Cross Reference

None

Program 20 : System Option Setup

20-30 : Timer Class for Trunks

Level:

IN

Description

Use **Program 20-30 : Timer Class for Trunks** to assign the timer class to each trunk. There are 16 Classes that can be assigned. You make eight entries for this Program, one for each Night Service Mode. The details of classes are assigned by Program 20-31.

Input Data

Trunk Port Number	001~200
-------------------	---------

Item No.	Item	Input Data	Default
01	Day/Night Mode 1~8, Class Number	0~15, #, * 0 = Not assigned	0

Conditions

None

Feature Cross Reference

None

Program 20 : System Option Setup

20-31 : Timer Class Timer Assignment

Level:
IN

Description

Use **Program 20-31 : Timer Class Timer Assignment** to assign values to the timers on a class of service basis.

Input Data

Timer Class Number	0~15
--------------------	------

Item No.	Item	Input Data	Default	Related Programming
01	Trunk Queuing Callback Duration Time Trunk Queuing Callback rings an extension for this time	0~64800 seconds	15 seconds	20-01-08
02	Callback / Trunk Queuing Cancel Time The system cancels an extension Callback or Trunk Queuing request after this time.	0~64800 seconds	64800 seconds	20-01-09
03	CAR/SIE/Virtual Extension Delay Interval CAR Keys/SIE Keys/Virtual Extensions set for Delayed Ringing (refer to 15-11 : Virtual Extension Delayed Ring Assignment) ring the extension after this time.	0~64800 seconds	10 seconds	20-04-03
04	Intercom Interdigits Time (Intercom I/D Timer) When placing Intercom calls, extension users must dial each digit in this time.	0~64800 seconds	10 seconds	21-01-02
05	Trunk Interdigits Time (Trunk I/D Timer) The system waits for this time to expire before placing the call in a talk state (Call Timer starts after time expires, Voice Over and Barge-In are not allowed until after time expires).	0~64800 seconds	5 seconds	21-01-03
06	Hotline Time Start Time (Hotline Start) A Ringdown extension automatically calls the programmed destination after this time.	0~64800 seconds	5 seconds	21-01-09

Item No.	Item	Input Data	Default	Related Programming
07	Ring No Answer Alarm Time If a trunk rings a multiline telephone longer than this time, the system changes the ring cadence. This indicates to the user that the call has been ringing too long.	0~64800 seconds	60 seconds	22-01-03
08	DIL/Incoming Ring Group No Answer Time A DIL that rings its programmed destination longer than this time diverts to the DIL No Answer Ring Group (set in Program 22-08).	0~64800 seconds	0 seconds	22-01-04
09	DID Ring-No-Answer Time In systems with DID Ring-No-Answer Intercept, this time sets the Ring-No-Answer time. This time is how long a DID call rings the destination extension before rerouting to the intercept ring group.	0~64800 seconds	20 seconds	22-01-06
10	Hold Recall Time (Non Exclusive Hold) A call on Hold recalls the extension that placed it on Hold after this time. This time works with the Hold Recall Callback Time (Program 24-01-02).	0~64800 seconds	90 seconds	24-01-01
11	Hold Recall CallBack Time (Non Exclusive Hold) A trunk recalling from Hold or Park rings an extension for this time. This time works with Hold Recall Time or Park Hold Time. After this time, the system invokes the Hold Recall Time again. Cycling between time Program 24-01-01 and 24-01-02 and Program 24-01-06 and 24-01-07 continues until a user answers the call.	0~64800 seconds	30 seconds	24-01-02
12	Exclusive Hold Recall Time A call left on Exclusive Hold recalls the extension that placed it on Hold after this time.	0~64800 seconds	90 seconds	24-01-03
13	Exclusive Hold Recall Callback Time An Exclusive Hold Recall rings an extension for this time. If not picked up, the call goes back on System Hold.	0~64800 seconds	30 seconds	24-01-04
14	Park Hold Time – Normal A call left parked longer than this time recalls the extension that initially parked it.	0~64800 seconds	90 seconds	24-01-06

Item No.	Item	Input Data	Default	Related Programming
15	Delayed Call Forwarding Time (Call Forward No Answer) If activated at an extension, Delayed Call Forwarding occurs after this time. This also sets the time a Transferred call waits at an extension forwarded to Voice Mail before routing to the called extension mailbox.	0~64800 seconds	10 seconds	24-02-03
16	Transfer Recall Time An unanswered transferred call recalls after this time to the extension that initially transferred it.	0~64800 seconds	30 seconds	24-02-04
17	VRS/DISA No Answer Time (Disconnect or IRG or VM) A VRS/DISA caller can ring an extension for this time before the system sets the call as a Ring No Answer. After this time expires, the call follows the programmed Ring No Answer routing (set in Program 25-03 and 25-04).	0~64800 seconds	0 seconds	25-07-02
18	Disconnect after Re-transfer to IRG	0~64800 seconds	60 seconds	25-07-03
19	Long Conversation Warning Tone Time (Trunk to Trunk) Determine the time a DISA caller or any trunk-to-trunk (such as Tandem Trunking) conversation can last before the Long Conversation tone is heard.	0~64800 seconds	3600 seconds	25-07-07
20	Long Conversation Disconnect (Trunk to Trunk) This determines the time the system waits before disconnecting a DISA caller or any trunk-to-trunk (such as Tandem Trunking) conversation call after the Long Conversation tone is heard.	0~64800 seconds	10 seconds	25-07-08
21	DISA Internal Paging Time This is the maximum length of an Internal Page placed by a DISA caller. If the Page continues longer than this time, the system terminates the DISA call.	0~64800 seconds	30 seconds	25-07-09
22	DISA External Paging Time This is the maximum length of an External Page placed by a DISA caller. If the Page continues longer than this time, the system terminates the DISA call.	0~64800 seconds	30 seconds	25-07-10
23	Page Announcement Duration This timer sets the maximum length of Page announcements. (Affects External Paging only)	0~64800 seconds	1200 seconds	31-01-02

Conditions

- These timers are used when an extension or trunk is assigned to a class from 1 to 16 in 20-29-01 or 20-30-01. When the timer class is set to 0, the system-wide timer is used.
- All defaults are the same as the system-wide timers.

Feature Cross Reference

None

Program 20 : System Option Setup

20-35 : Extension's Operator Setting

Level:
IN

Description

Use **Program 20-35 : Extension's Operator Setting** to assign an extension to an operator group.

Input Data

Extension Number	Up to eight digits
------------------	--------------------

Item No.	Item	Input Data	Default
01	Extension's Operator Setting	0~15	0

Conditions

None

Feature Cross Reference

None

Program 20 : System Option Setup

20-36 : Trunk's Operator Setting

Level:

IN

Description

Use **Program 20-36 : Trunk's Operator Setting** to assign a trunk to an operator group.

Input Data

Trunk Port Number	001~200
-------------------	---------

Item No.	Item	Input Data	Default
01	Trunk's Operator Setting Allow the user to select Operator Group per trunk.	0~15 (0 = Not assigned)	0

Conditions

None

Feature Cross Reference

None

Program 20 : System Option Setup

20-37 : Operator Extension Group Setup

Level:
IN

Description

Use **Program 20-37 : Operator Extension Group Setup** to define the operator(s) in the operator group.

Input Data

Operator Group	1~15
----------------	------

Input Data

Operator Number	1~8
-----------------	-----

Item No.	Item	Input Data	Default
01	Operator Extension Group Setup	Up to eight digits	None

Conditions

None

Feature Cross Reference

None

Program 20 : System Option Setup

20-38 : Operator Group Setting

Level:

IN

Description

Use **Program 20-38 : Operator Group Setting** to set up priority of a call when calling an operator telephone.

Input Data

Operator Group	1~15
----------------	------

Item No.	Item	Input Data	Default
01	Operator Access Mode Assign if the operator is called, starting with the first operator, every time (0) or a different operator is tried first (1).	0 = Step 1 = Circular	0

Conditions

None

Feature Cross Reference

None

THIS PAGE INTENTIONALLY LEFT BLANK

Program 21 : Outgoing Call Setup

21-01 : System Options for Outgoing Calls

Level:
IN

Description

Use **Program 21-01 : System Options for Outgoing Calls** to set the system options for Outgoing Call Service.

Input Data

Item No.	Item	Input Data	Default	Related Program
01	Seizure Trunk Line Mode Select the trunk based off the Trunk Route Priority (0) or based off the trunk that has not been used in the longest time (1).	0 = Priority Route 1 = Circular Route	0	14-05 14-06
02	Intercom Interdigit Time When placing Intercom calls, an extension user must dial each digit in this time.	0~64800 (sec)	10	
03	Trunk Interdigit Time (External) The system waits for this time to expire before placing the call in a talk state (Call Timer starts after time expires, Voice Over and Barge-In are not allowed until after time expires).	0~64800 (sec)	5	14-02-08
04	Dial Tone Detection Time If dial tone detection is enabled, the system waits this time for the Telco to return dial tone. When the time expires, the system assumes dial tone is not present. To disable this time (and have the system wait continuously), enter 0.	0~64800 (sec)	5	14-02-05

Program

21

Input Data

Item No.	Item	Input Data	Default	Related Program
05	<p>Disconnect Time when Dial Tone not Detected</p> <p>If 14-02-11 is enabled, the system skips over a trunk if dial tone is not detected. This option pertains to calls placed using Speed Dial, ARS, Last Number Redial or Save Number dialed. It does not pertain to line key or Direct Trunk Access calls.</p>	0~64800 (sec)	3	
06	<p>Dial Pause at First Digit</p>	0~64800 (sec)	1	
07	<p>Toll Restriction Override Time</p> <p>After dialing the Toll Restriction Override codes, the system removes Toll Restriction from the extension for this time.</p>	0~64800 (sec)	10	20-08-06 21-07
08	<p>Preset Dial Display Hold Time</p>	0~64800 (sec)	10	
09	<p>Ringdown Extension Timer (Hotline Start)</p> <p>A Ringdown extension automatically calls its programmed destination after this time.</p>	0~64800 (sec)	5	20-08-09 21-11
10	<p>Dial Digits for Toll Restriction Path</p> <p>If this option is programmed with an entry other than 0, a call does not have a talk path unless the user dials at least the number of digits entered in this option when placing an outgoing call.</p> <p>This means that an entry of 4 or higher in this program causes a problem when dialing 911(USA only). Since it is only a 3-digit number, the call does not have a talk path, preventing the emergency dispatcher from hearing the caller. This option should be kept at its default setting of 0 to prevent any problems with dialing 911 (USA only).</p>	0~24	0	
11	<p>Inter-Digit Time for Toll Restriction Path Control</p>	0~60	0	

Input Data

Item No.	Item	Input Data	Default	Related Program
12	Dial E911 Routing Without Trunk Access If enabled (1), an extension user can dial 911 (USA only) without first dialing a trunk access code or pressing a line key. If disabled (0), an extension user must dial a trunk access code (e.g., 9) or press a line key before dialing 911 (USA only).	0 = Trunk Access Code Required 1 = Trunk Access Code Not Required	1	
13	Alarm Ring Timer (E911) Set the duration of the E911 Alarm Ring Time. If set for 0, the E911 Alarm does not ring.	0, 1~64800 (sec) (0 = Off)	0	11-12-56 20-08-16
14	Forced Account Code Inter-digit Timer The system waits this time for a user to enter a Forced Account code.	0~64800 (sec)	3	
15	Outgoing Disable on Incoming Line (Toll Restriction) Enable/Disable the Outgoing Disable on Incoming Line feature.	0 = Disable (Off) 1 = Enable (On)	0	15-01-05 21-01-16 21-01-17
16	Supervise Dial Detection Timer With the Outgoing Disable on Incoming Line feature, if dial tone is not detected after the extension answers an incoming line, the system determines the call is unable to complete and releases the DTMF receiver.	0~64800 (sec)	20	15-01-05 21-01-16 21-01-17
17	Restriction Digit in Outgoing Disable on Incoming Line With the Outgoing Disable on Incoming Line feature, determine the number of digits to be dialed before the call should be disconnected.	Digits 0~9	4	15-01-05 21-01-15 21-01-16
18	Reset Dial After Failure of Trunk Access Enable/Disable the ability to continue to dial codes or extensions after receiving Trunk Busy. This must be set to 1 for the Forced Trunk Disconnect feature to work.	0 = Disable (Off) 1 = Enable (On)	1	
19	--- Not Used ---			

Conditions

None

Feature Cross Reference

- Central Office Calls, Placing

Program 21 : Outgoing Call Setup

21-02 : Trunk Group Routing for Extensions

Level:

IN

Description

Use **Program 21-02 : Trunk Group Routing for Extensions** to assign Program 14-06 routes to extensions.

Input Data

Extension Number	Maximum eight digits
------------------	----------------------

Item No.	Day/Night Mode	Route Table Number	Default	Related Program
01	1~8	0~100 (0 = No Setting)	1	14-06 14-01-07

Conditions

None

Feature Cross Reference

None

Program 21 : Outgoing Call Setup

21-03 : Trunk Group Routing for Trunks

Level:
IN

Description

Use **Program 21-03 : Trunk Group Routing for Trunks** to set the Trunk Route Table for Automatic External Call Forward. The Route Table is set in Program 14-06.

Input Data

Trunk Port Number	001~200
-------------------	---------

Item No.	Day/Night Mode	Route Table Number	Default	Related Program
01	1~8	0~100 (0 = No setting)	1	14-06 14-07-01

Conditions

None

Feature Cross Reference

- Trunk Group Routing

Program 21 : Outgoing Call Setup

21-04 : Toll Restriction Class for Extensions

Level:
IN

Description

Use **Program 21-04 : Toll Restriction Class for Extensions** to assign a Toll Restriction class to an extension. The details of Toll Restriction are defined in Program 21-05 and 21-06.

 **A telephone and a trunk have a Restriction Class. The higher class applies for outgoing calls.**

Input Data

Extension Number	Maximum eight digits
------------------	----------------------

Item No.	Day/Night Mode	Restriction Class	Default	Related Program
01	1~9 9 = (Power Failure Mode)	1~15	2	14-01-08 21-05

Conditions

None

Feature Cross Reference

None

Program 21 : Outgoing Call Setup

21-05 : Toll Restriction Class

Level:
IN

Description

Use Program 21-05 : Toll Restriction Class to set the system Toll Restriction classes (1~15).

Input Data

Toll Restriction Class Number	1~15
-------------------------------	------

Item No.	Item	Input Data	Default	Description	Related Program
01	International Call Restriction Table	0 = Unassigned (No) 1 = Assigned (Yes)	1, 6~15 = 0 2~5 = 1	Assign/Unassign the International Call Restrict Table for the Toll Restriction Class you are programming. Enter International Call Restrict Table data in Program 21-06-01.	21-06-01
02	International Call Permit Code Table	0 = Unassigned (No) 1 = Assigned (Yes)	1, 3~15 = 0 2 = 1	Assign/Unassign the International Call Permit Table for the Toll Restriction Class you are programming. Enter International Call Permit Table data in Program 21-06-02.	21-06-02
03	--- Not Used ---				
04	Maximum Number of Digits Table Assignment	1~4 = Table 0 = Disable (None)	1, 2, 6~15 = 0 3 = 1 4 = 2 5 = 3	Select the table (defined in 21-06-03) to be used to determine the maximum number of digits allowed for outgoing calls.	21-06-03
05	Common Permit Code Table	0 = Unassigned (No) 1 = Assigned (Yes)	1, 8~15 = 0 2~7 = 1	Choose whether the table set up by 21-06-04 is referred to or not.	21-06-04
06	Common Restriction Table	0 = Unassigned (No) 1 = Assigned (Yes)	1, 6~15 = 0 2~5 = 1	Choose whether the table set up by 21-06-05 is referred to or not.	21-06-05
07	Permit Code Table	1~4 = Table 0 = Disable (None)	1, 2, 6~15 = 0 3 = 1 4 = 2 5 = 3	Set the tables 1~4 when referring to the table set up by 21-06-06.	21-06-06

Item No.	Item	Input Data	Default	Description	Related Program
08	Restriction Table	1~4 = Table 0 = Disable (None)	1, 2, 6~15 = 0 3 = 1 4 = 2 5 = 3	Set the tables 1~4 when referring to the table set up by 21-06-07.	21-06-07
09	Restriction for Common Speed Dials	0 = Does Not Restrict 1 = Following Restriction Check	0	Enable/Disable Toll Restriction for Common Speed Dialing numbers. If enabled, System Speed Dialing numbers have the same restrictions as manually dialed numbers.	
10	Restriction for Group Speed Dials	0 = Does Not Restrict 1 = Following Restriction Check	0	Enable/Disable Toll Restriction for Group Speed Dialing numbers. If enabled, Group Speed Dialing numbers have the same restrictions as manually dialed numbers.	
11	Intercom Call Restriction	0 = Disable (No) 1 = Enable (Yes)	0	Determine if incoming and outgoing intercom calls are allowed.	
12	PBX Call Restriction	0 = Disable (No) 1 = Enable (Yes)	1~6, 8~15 = 0 7 = 1	Set how the system Toll Restricts calls over PBX trunks. If you enable PBX Toll Restriction, the system begins Toll Restriction after the PBX access code. The user cannot dial a PBX extension. If you disable PBX Toll Restriction, the system only restricts calls that contain the PBX access code. The system does not restrict calls to PBX extensions. Refer to the PBX compatibility feature. Make sure Program 21-05-04 (Maximum Number of Digits Table Assignment) allows for PBX Toll Call Dialing (normally 12 digits).	
13	Restriction of Tie Line Calls	0 = Disable (No) 1 = Enable (Yes)	0	Enable/Disable the toll restriction of the dial set up by 34-08.	34-08
14	Trunk Transfer Restriction on Incomplete Dial	0 = Not allow 1 = Allow	0 (Not allow)	If this program is set to 1, you can transfer the outgoing trunk which you dialed incompletely.	
15	Common Hold Restriction on Incomplete Dial	0 = Not allow 1 = Allow	0 (Not allow)	If this program is set to 1, you can hold the outgoing trunk which you dialed in restriction check.	

Default

Item	Toll Restriction Class														
	1	2	3	4	5	6	7	8	9	10	11	12	13	14	15
01: International Call Restrict Table	0	1	1	1	1	0	0	0	0	0	0	0	0	0	0
02: International Call Permit Table	0	1	0	0	0	0	0	0	0	0	0	0	0	0	0
03: --- Not Used ---	0	0	0	0	0	0	0	0	0	0	0	0	0	0	0
04: Max. No. Digits Table Assign.	0	0	1	2	3	0	0	0	0	0	0	0	0	0	0
05: Common Permit Table	0	1	1	1	1	1	1	0	0	0	0	0	0	0	0
06: Common Restrict Table	0	1	1	1	1	0	0	0	0	0	0	0	0	0	0
07: Permit Code Table	0	0	1	2	3	0	0	0	0	0	0	0	0	0	0
08: Restrict Code Table	0	0	0	0	0	0	0	0	0	0	0	0	0	0	0
09: Restriction for Common Abbr. Dials	0	0	0	0	0	0	0	0	0	0	0	0	0	0	0
10: Restriction for Group Abbr. Dials	0	0	0	0	0	0	0	0	0	0	0	0	0	0	0
11: Intercom Call Restriction	0	0	0	0	0	0	0	0	0	0	0	0	0	0	0
12: Restriction of PBX Calls	0	0	0	0	0	0	1	0	0	0	0	0	0	0	0
13: Restriction of Tie Line Calls	0	0	0	0	0	0	0	0	0	0	0	0	0	0	0
14: Restriction for Incomplete Dialed Trunk Transfer	0	0	0	0	0	0	0	0	0	0	0	0	0	0	0
15: Allow the Outgoing Trunk to Common Hold	0	0	0	0	0	0	0	0	0	0	0	0	0	0	0

Conditions

None

Feature Cross Reference

None

Program 21 : Outgoing Call Setup

21-06 : Toll Restriction Table Data Setup

Level:

IN

Description

Use **Program 21-06 : Toll Restriction Table Data Setup** to set the system Toll Restriction data. Dial 1-9, 0, *, # can be entered in each table.

Input Data

Item No.	Item	Table	Input Data	Default	Description
01	International Call Restriction Table	1~10	Dial (Up to four digits)	Tables 1~10 = No Setting	Program the Restrict Table for international calls. The system has 10 International Call Restrict Tables. Each entry can have up to four digits.
02	International Call Permit Code Table	1~20	Dial (Up to six digits)	Tables 1~20 = No Setting	Program the Permit Table for international calls. The system has 20 International Call Permit Tables. Each entry can have up to six digits.
03	Maximum Number Digits Table Assignment	1~4	4~30	Tables 1~ 4 = 30	Select the maximum number of digits allowed in outgoing calls for each table.
04	Common Permit Code Table	1~10	Dial (Up to four digits)	Table 1 = 911 Table 2 = 1800 Table 3 = 1888 Table 4 = 1822 Table 5 = 1833 Table 6 = 1844 Table 7 = 1855 Table 8 = 1866 Table 9 = 1877 Table 10 = No Setting	Program the Common Permit Code Table. This table contains up to 10 codes you commonly allow users to dial.
05	Common Restriction Table	1~10	Dial (Up to 12 digits)	Table 1 = 900 Table 2 = 1900 Table 3 = 976 Tables 4 ~ 10 = No Setting	Program the Common Restrict Code Table. This table contains up to 10 codes you commonly prevent users from dialing.

Input Data

Item No.	Item	Table	Input Data	Default	Description
06	Permit Code Table	1~4 (table) 001~200 (Entry)	Dial (Up to 12 digits)	Table 1~4 = No Setting	Program the Permit Code Tables. If the system has Toll Restriction enabled, users can dial numbers only if permitted by these tables and the Common Permit Table (21-06-04). There are four Permit Code Tables, with up to 200 entries in each table. The system permits calls exactly as you enter the code.
07	Deny Restriction Table	1~4 (table) 1~60 (Entry)	Dial (Up to 12 digits)	Table 1~4 = No Setting	Program the Restrict Code Tables. If the system has Toll Restriction enabled, users cannot dial numbers listed in these tables. There are four Restrict Code Tables, with up to 200 entries in each table. The system restricts calls exactly as you enter the code.
08	PBX Access Code	1~4	Dial (Up to two digits)	Table 1~4 = No Setting	Enter the PBX Access Code. When the system is behind a PBX, this is the code users dial to access a PBX trunk. Toll Restriction begins after the PBX access code. For PBX trunks (Program 14-04) the system only Toll Restricts calls that contain the access code. Always program this option when the system is behind a PBX, even if you don't want to use Toll Restriction. PBX Access Codes can have up to two digits, using 0-9, #, * and LINE KEY 1 (don't care). When using Account Codes, do not use an asterisk in a PBX access code. Otherwise, after the *, the trunk stops sending digits to the central office. Entries 1~4 correspond to the 4 PBX Access Codes. Each code can have up to two digits.
09	Specific Dial Outgoing Code	1~20	Dial (Up to eight digits)	No Setting	
10	Outgoing Call Code Setup	1~20	Dial (Up to four digits)	No Setting	

Conditions

None

Feature Cross Reference

None

Program 21 : Outgoing Call Setup

21-07 : Toll Restriction Override Password Setup

Level:
SA

Description

Use **Program 21-07 : Toll Restriction Override Password Setup** to assign Toll Restriction Override codes to extension ports. Each code must have four digits, using any combination of 0~9, # and *. Each extension can have a separate code, or many extensions can share the same override code.

Input Data

Extension Number	Maximum eight digits
------------------	----------------------

Item No.	Password	Default	Related Program
01	Four Digits (Fixed)	No Setting	21-01-07 20-08-06

Conditions

None

Feature Cross Reference

None

Program 21 : Outgoing Call Setup

21-08 : Repeat Dial Setup

Level:
IN

Description

Use **Program 21-08 : Repeat Dial Setup** to define the automatic Repeat Dial data.

Input Data

Item No.	Item	Input Data	Default
01	Repeat Redial Count Set how many times a Repeat Redial automatically repeats if the call does not go through.	0~255	3
02	Repeat Redial Interval Time Set the time between Repeat Redial attempts.	0~64800 (sec)	60
03	Repeat Dial Calling Timer After dialing the trunk call, Repeat Redial maintains the call after this time. After this time, the system terminates the call, waits the Repeat Redial Time (Timer 02) and tries again.	0~64800 (sec)	30
04	Time for Send Busy Tone for ISDN Trunk Set the time to send out Busy Tone with an ISDN line, when called party is busy.	0~64800 (sec)	0

Conditions

None

Feature Cross Reference

None

Program 21 : Outgoing Call Setup

21-09 : Dial Block Setup

Level:
IN

Description

Use **Program 21-09 : Dial Block Setup** to define the Dial Blocking Toll Restriction Class and Dial Block Password to be used by the Supervisor extension.

Input Data

Item No.	Item	Input Data	Default
01	Toll Restriction Class With Dial Block Assign a Toll Restriction Class of Service when the Dial Block feature is used.	1~15	15
02	Supervisor Password Assign a 4-digit password to be used by the supervisor to enable or disable Dial Block for other extensions.	0~9, *, # (4-digit fixed)	No Setting

Conditions

- This function works by password and Class of Service control (the supervisor is not an assigned extension). If Dial Block is available for all Classes of Service, everyone may become a supervisor if they know the Dial Block password.

Feature Cross Reference

None

Program 21 : Outgoing Call Setup

21-10 : Dial Block Restriction Class Per Extension

Level:

IN

Description

Use **Program 21-10 : Dial Block Restriction Class Per Extension** to define the Toll Restriction Class to each extension when the extension is set for Dial Block Restriction. If this data is 0, Toll Restriction Class follows Program 21-09-01.

Input Data

Extension Number	Maximum eight digit
------------------	---------------------

Item No.	Toll Restriction Class	Default
01	0, 1~15 (0 = No Setting)	0

Conditions

None

Feature Cross Reference

None

Program 21 : Outgoing Call Setup

21-11 : Extension Ringdown (Hotline) Assignment

Level:
IN

Description

Use **Program 21-11 : Extension Ringdown (Hotline) Assignment** to define the Hotline destination number for each extension number.

Input Data

Extension Number	Maximum eight digits
------------------	----------------------

Item No.	Hotline Destination Number	Default	Related Program
01	0, *, #, Pause, Hook Flash, @ (Code to wait for answer supervision) (maximum 24 digits)	No Setting	20-08-09 21-01-09

Conditions

- Use the @ code to make an outbound call automatically to a DISA Trunk or to VM Auto Attendant. This code can be used only on ISDN outbound calls. Internal calls and analog outbound calls are not supported.

Feature Cross Reference

- Ringdown Extension, Internal/External

Program 21 : Outgoing Call Setup

21-12 : ISDN Calling Party Number Setup for Trunks

Level:

IN

Description

Use **Program 21-12 : ISDN Calling Party Number Setup for Trunks** to assign Calling Party Numbers for each trunk (maximum 16 digits per entry). When a call is made by an extension which does not have an Extension Calling Number assigned (Program 21-13), the system sends the calling number for the ISDN trunk defined in 21-12.

 *If the Calling Party Number is assigned in both Programs 21-12 and 21-13, the system sends the data in Program 21-13.*

Input Data

Trunk Port Number	001~200
-------------------	---------

Item No.	Calling Party Number Data	Default
01	1~0, *, # (maximum 16 digits)	No Setting

Conditions

None

Feature Cross Reference

- ISDN Compatibility

Program 21 : Outgoing Call Setup

21-13 : ISDN Calling Party Number Setup for Extensions

Level:
IN

Description

Use **Program 21-13 : ISDN Calling Party Number Setup for Extensions** to assign each extension a Calling Party Number (maximum 16 digits per entry). The calling number is the subscriber number of the dial-in number. When a call is made by an extension which does not have an Extension Calling Number assigned (Program 21-13), the system sends the calling number for the ISDN trunk defined in Program 21-12.

 *If a Calling Party Number is assigned in both Programs 21-12 and 21-13, the system sends the data in Program 21-13.*

Input Data

Extension Number	Maximum eight digits
------------------	----------------------

Item No.	Calling Party Number Data	Default
01	0~9, *, # (Max. 16 digits)	No setting

Conditions

None

Feature Cross Reference

- ISDN Compatibility

Program 21 : Outgoing Call Setup

21-14 : Walking Toll Restriction Password Setup

Level:
SA

Description

Use **Program 21-14 : Walking Toll Restriction Password Setup** to assign the password and Toll Restriction Class for Walking Toll Restriction. Each code has six digits, using any combination of 0~9, # and *.

Input Data

ID Table Number	1~500
-----------------	-------

Item No.	Item	Input Data	Default
01	User ID	Dial (Six digits)	No Setting
02	Walking Toll Restriction Class Number	1~15	1

Conditions

None

Feature Cross Reference

- Toll Restriction

Program 21 : Outgoing Call Setup

21-15 : Individual Trunk Group Routing for Extensions

Level:
IN

Description

Use **Program 21-15 : Individual Trunk Group Routing for Extensions** to designate the alternate trunk access route accessed when a user dials the Alternate Trunk Route Access Code. Refer to Program [11-09 : Trunk Access Code](#) when setting up alternate trunk codes. Refer to [14-06 : Trunk Group Routing](#) to set up the trunk routes. When entering data for this option, enter the route number or 0 to prevent routing.

Input Data

Extension Number	Maximum eight digits
------------------	----------------------

Item No.	Day/Night Mode	Route Table Number	Default
01	1~8	0~100 (0 = No Setting)	0

Conditions

None

Feature Cross Reference

- Central Office Calls, Placing

Program 21 : Outgoing Call Setup

21-17 : IP Trunk (SIP) Calling Party Number Setup for Trunk

Level:

IN

Description

Use **Program 21-17 : IP Trunk (SIP) Calling Party Number Setup for Trunk** set the SIP calling party number for individual trunks.

Input Data

Trunk Port Number	001~200
-------------------	---------

Item No.	Description	Input Data	Default
01	IP Trunk (SIP) Calling Party Number Setup for Trunk	Up to 16 digits (1~0, *, #)	None

Conditions

None

Feature Cross Reference

None

Program 21 : Outgoing Call Setup

21-18 : IP Trunk (H.323) Calling Party Number Setup for Extension

Level:

IN

Description

Use **Program 21-18 : IP Trunk (H.323) Calling Party Number Setup for Extension** to assign the Calling Party Number for each extension. The assigned number is sent to the exchange when the caller places an outgoing call.

 *When the Calling Party Number is assigned by PRG 21-17, 21-18 and 21-19, the system uses the data in PRG 21-18 and PRG 21-19.*

Input Data

Extension Number	Up to eight digits
------------------	--------------------

Item No.	Description	Input Data	Default
01	IP Trunk (H.323) Calling Party Number Setup for Extension	Up to 16 digits (1~0, *, #)	None

Conditions

None

Feature Cross Reference

None

Program 21 : Outgoing Call Setup

21-19 : IP Trunk (SIP) Calling Party Number Setup for Extension

Level:

IN

Description

Use **Program 21-19 : IP Trunk (SIP) Calling Party Number Setup for Extension** to set the SIP calling party number for an individual extension.

Input Data

Extension Number	Maximum eight digits
------------------	----------------------

Item No.	Description	Input Data	Default	Related Program
01	IP Trunk (SIP) Calling Party Number Setup for Extension	Up to 16 Digits (1~0, *, #)	None	15-01-04 20-08-13

Conditions

None

Feature Cross Reference

None

Program 21 : Outgoing Call Setup

21-21 : Toll Restriction for Trunks (Seized Trunk Basis Setting)

Level:

IN

Description

Use **Program 21-21 : Toll Restriction for Trunks (Seized Trunk Basis Setting)** to define the toll restriction class to each trunk. The details of toll restriction are defined by PRG 21-05 and 21-06.

This program is compared to Station Restriction Class. The higher class is applied.

Input Data

Trunk Port Number	001~200
-------------------	---------

Item No.	Description	Input Data	Default	Related Program
01	Restriction Class Enter the Toll Restriction Class for the selected trunk.	1~15	1	14-01-08 21-05

Conditions

None

Feature Cross Reference

None

Program 21 : Outgoing Call Setup

21-22 : CO Message Waiting Indication – Call Back Settings

Level:

IN

Description

Use **Program 21-22 : CO Message Waiting Indication – Call Back Settings** to define the settings of CO Message Waiting Indication.

Input Data

Trunk	001~200
-------	---------

Item No.	Description	Input Data	Default
01	CO MWI Call Back Enabling Enable/Disable CO MWI Call Back.	0 = No VMWI Service 1 = Enable VMWI Service	0
02	CO MWI Call Back Number Area Setting Define the Speed Dial Bin number for MWI Call Back.	0000~1999	1999

Conditions

None

Feature Cross Reference

None

THIS PAGE INTENTIONALLY LEFT BLANK

Program 22 : Incoming Call Setup

22-01 : System Options for Incoming Calls

Level:
IN

Description

Use **Program 22-01 : System Options for Incoming Calls** to define the system options for incoming calls.

Input Data

Item No.	Item	Input Data	Default	Description	Related Program
01	Incoming Call Priority	0 = Intercom Call Priority 1 = Trunk Call Priority	1	Determine if Intercom calls or trunk calls have answer priority when both are ringing simultaneously.	15-02-22
02	Incoming Call Ring No Answer Alarm	0 = Disable (Off) 1 = Enable (On)	0	If enabled, an incoming call that rings longer than the Ring No Answer Alarm (22-01-03), changes to a unique ring cadence to indicate that the call has been ringing too long. If disabled, this does not occur.	22-01-03 22-01-04
03	Ring No Answer Alarm Time	0~64800 (sec)	60	If a trunk rings a multiline telephone longer than this time, the system changes the ring cadence. This indicates to the user that the call has been ringing too long.	22-01-02
04	DIL No Answer Recall Time	0~64800 (sec)	0	A DIL that rings its programmed destination longer than this time diverts to the DIL No Answer Ring Group (set in Program 22-08).	
05	--- Not Used ---				
06	DID Ring-No-Answer Time	0~64800 (sec)	20	In systems with DID Ring-No-Answer Intercept, this sets the Ring-No-Answer time. This is the time a DID call rings the destination extension before rerouting to the intercept ring group.	22-12
07	DID Incoming Ring Group No Answer Time	0~64800 (sec)	20		

Program

22

Input Data

Item No.	Item	Input Data	Default	Description	Related Program
08	DID Pilot Call No Answer Time	0~64800 (sec)	60		
09	DID to Trunk to Trunk no answer timer	0~64800 (sec)	20		
10	VRS Waiting Message Operation	0 = Enable Always 1 = Change by Manual Operation	0	Set up the operation mode for Auto Attendant and Queuing Message.	22-14 22-15 22-08 22-04 22-01-04 20-15-11 15-07
11	VRS Waiting Message Interval Time	0~64800 (sec)	20	Set up the sending duration time of the Auto – Attendant & Queuing. The message is repeatedly sent out during the specified time.	22-14-06 22-15-06 41-11-06

Conditions

None

Feature Cross Reference

- Central Office Calls, Answering

Program 22 : Incoming Call Setup

22-02 : Incoming Call Trunk Setup

Level:
IN

Description

Use **Program 22-02 : Incoming Call Trunk Setup** to assign the incoming trunk type for each trunk. There is one item for each Night Service Mode.

Input Data

Trunk Port Number	001~200
-------------------	---------

Item No.	Day/Night Mode	Incoming Type	Default	Description	Related Program
01	1~8	0 = Normal 1 = VRS (second dial tone if no VRS installed) 2 = DISA 3 = DID 4 = DIL 5 = E&M Tie line 6 = Delayed VRS 7 = ANI/DNIS 8 = DID(DDI) Mode Switching	0	Set the feature type for the trunk you are programming.	14-04

Conditions

- When connecting to T1 trunks, after changing Program 22-02-01 to match the Telco connected T1 service type, the T1 cable or the T1 blade must be unplugged and then reconnected for the T1 blade to sync.
- When the trunk type is set to 3 (DID), the DID Transfer to Destination in 22-11-04 for each DID feature is not supported. This feature is supported only for DID trunks when assigned as VRS.
- When the trunk type is set to 3 (DID), the DID Intercept Destination feature for each DID is not supported. This feature is supported only for DID trunks assigned as VRS.

Feature Cross Reference

- Central Office Calls, Answering

Program 22 : Incoming Call Setup

22-03 : Trunk Ring Tone Range

Level:
IN

Description

Use **Program 22-03 : Trunk Ring Tone Range** to select the ring tone range for the trunk. The trunk uses a ring tone in the range selected when it rings an extension. Eight ring tones are available. Customize the Trunk Ring Tones in Program 82-01.

Input Data

Trunk Port Number	001~200
-------------------	---------

Item No.	Ring Tone Pattern	Default	Description	Related Program
01	0~8 (Ring Tone Pattern 1~4) (Melody 1~ Melody 5)	0	Select the ring tone range for the trunk. The trunk uses a ring tone in the range selected when it rings an extension. Eight ring tones are available.	15-02

Table 2-8 Program 22-03 – Incoming Signal Frequency Patterns

Incoming Signal Frequency Pattern	Type	Frequency 1	Frequency 2	Modulation
Pattern 1	High Middle Low	1100Hz 660Hz 520Hz	1400Hz 760Hz 660Hz	16Hz 16Hz 16Hz
Pattern 2	High Middle Low	1100Hz 660Hz 520Hz	1400Hz 760Hz 660Hz	8Hz 8Hz 8Hz
Pattern 3	High Middle Low	2000 1400 1100	760 660 540	16Hz 16Hz 16Hz
Pattern 4	High Middle Low	2000 1400 1100	760 660 540	8Hz 8Hz 8Hz

Conditions

None

Feature Cross Reference

- Selectable Ring Tones

Program 22 : Incoming Call Setup

22-04 : Incoming Extension Ring Group Assignment

Level:
SA

Description

Use **Program 22-04 : Incoming Extension Ring Group Assignment** to assign extensions to Ring Groups. Calls ring extensions according to Ring Group programming. Use Program 22-05 to assign trunks to Ring Groups and use Program 22-06 to set the ringing for the phones. An Incoming Ring Group (IRG) can have up to 32 extension numbers assigned.

 *There are 100 available Ring Groups.*

Input Data

Incoming Ring Group Number	1~100
----------------------------	-------

Item No.	Extension Number	Description	Related Program
01	Maximum 8 Digits	Assign extensions (up to 32) to Ring Groups. Calls ring extensions according to Ring Group programming.	22-02 22-05 22-06

Default

- Extensions 101~108 (first eight ports) ring for incoming Ring Group 1 calls. No other extensions ring for incoming Ring Group 1 calls.

Conditions

None

Feature Cross Reference

- Ring Groups

Program 22 : Incoming Call Setup

22-05 : Incoming Trunk Ring Group Assignment

Level:

IN

Description

Use **Program 22-05 : Incoming Trunk Ring Group Assignment** to assign trunks to incoming Ring Groups. There are 100 available Ring Groups.

Input Data

Trunk Port Number	001~200
-------------------	---------

Item No.	Day/Night Mode	Incoming Group Number	Default	Description	Related Program
01	1~8	0 = No Setting 001~100 (Incoming Group) 102 (In-Skin/ External Voice Mail or VM8000 InMail)	1	Assign Normal Ring Trunks (22-02) to Incoming Ring Groups (22-04).	22-04 22-06

Conditions

None

Feature Cross Reference

- Ring Groups

Program 22 : Incoming Call Setup

22-06 : Normal Incoming Ring Mode

Level:

IN

Description

Use **Program 22-06 : Normal Incoming Ring Mode** to define whether or not an extension should ring for the Normal Incoming Ring Mode.

Input Data

Extension Number	Maximum eight digits
------------------	----------------------

Item No.	Day/Night Mode	Incoming Group Number	Default	Related Program
01	1~8	0 = No Ring 1 = Ring	1	22-04 22-05

Conditions

None

Feature Cross Reference

- Central Office Calls, Answering

Program 22 : Incoming Call Setup

22-07 : DIL Assignment

Level:
IN

Description

Use **Program 22-07 : DIL Assignment** to assign the destination extension or Department Calling Group for each DIL Incoming trunk. A DIL rings an extension directly, without any other Access Map or Ring Group programming. If an extension has a line key, the DIL rings the line key. If the extension does not have a line key, the DIL rings CAP keys. Use Program 22-02 to designate a trunk as a DIL. You can make eight DIL assignments, one for each Night Service mode.

Input Data

Trunk Port Number	001~200
-------------------	---------

Item No.	Day/Night Mode	Number of Transferring Destination	Default
01	1~8	Extension Number (maximum eight digits) Pilot Number	No Setting

Conditions

- Program 22-02 must be set to four for the trunk.

Feature Cross Reference

- Direct Inward Line (DIL)

Program 22 : Incoming Call Setup

22-08 : DIL/IRG No Answer Destination

Level:

IN

Description

For DIL Delayed Ringing, use **Program 22-08 : DIL/IRG No Answer Destination** to assign the DIL No Answer Ring Group. An unanswered DIL rings this group after the DIL No Answer Time expires (Program 22-01-04). DIL Delayed Ringing can also reroute outside calls ringing a Ring Group.

Make eight assignments, one for each Night Service mode.

Input Data

Trunk Port Number	001~200
-------------------	---------

Item No.	Day/Night Mode	Incoming Group Number	Default
01	1~8	0 = No Setting 001~100 (Incoming Ring Group) 102 (In-Skin/ External Voice Mail or VM8000 InMail)	1

Conditions

None

Feature Cross Reference

- Direct Inward Line (DIL)
- Ring Group

Program 22 : Incoming Call Setup

22-09 : DID Basic Data Setup

Level:
IN

Description

Use **Program 22-09 : DID Basic Data Setup** to define the basic setting of Dial-In incoming calls for each trunk group.

Input Data

Trunk Group Number	001~100
--------------------	---------

Item No.	Item	Input Data	Default
01	Expected Number of Digits Enter the number of digits the table expects to receive from the telco. Use this program to make the system compatible with 3- and 4-digit DID service. If ISDN trunks, we analyze the last digits that are set here. If it is T-1 or analog DID, it analyzes the first digits that are assigned here.	1~8	4
02	Received Vacant Number Operation Enable/Disable Vacant Number Intercept.	0 = Disconnect (Cut) 1 = Transfer (Refer to Program 22-12 : DID Intercept Ring Group on page 2-312.)	0
03	Sub-Addressing Mode	0 = Extension # Specify (Intercom) 1 = DID Conversion Table	0
04	DID Receiving Mode for ISDN	0 = Enbloc Receiving 1 = Overlap Receiving	0
05	Local Code Digits (Only Overlap Receiving Mode)	0~15 (0 = No Local Code)	0
06	Local Code (Only Overlap Receiving Mode)	Dial (maximum 16 digits)	No Setting
07	Pilot Code (Only Overlap Receiving Mode)	Dial (1 digit: 0~9)	No Setting

Item No.	Item	Input Data	Default
08	T302 Time-out Operation (Only Overlap Receiving Mode)	0 = Disconnect (Cut) 1 = Transfer (Refer to Program 22-12 : DID Intercept Ring Group on page 2-312.)	0

Conditions

None

Feature Cross Reference

- Direct Inward Dialing (DID)

Program 22 : Incoming Call Setup

22-10 : DID Translation Table Setup

Level:
IN

Description

Use **Program 22-10 : DID Translation Table Setup** to specify the size of the DID Translation Tables. There are 2000 Translation Table entries that you can allocate among 20 Translation Tables.

Input Data

Conversion Table Area Number	01~20
------------------------------	-------

Item No.	Item	Input Data
01	1st Area Setup (Start Address)	0~2000 0 = No Setting
	1st Area Setup (End Address)	Default Table
	2nd Area Setup (Start Address)	Default Table
	2nd Area Setup (End Address)	Default Table

Default Table

Conversion Table Area	1st		2nd	
	Start Table	End Table	Start Table	End Table
1	1	100	0	0
2	101	200	0	0
3	201	300	0	0
4	301	400	0	0
:	:	:	:	:
20	0	0	0	0

Conditions

None

Feature Cross Reference

- Direct Inward Dialing (DID)

Program 22 : Incoming Call Setup

22-11 : DID Translation Number Conversion

Level:
SA

Description

Use **Program 22-11 : DID Translation Table Number Conversion** to specify for each Translation Table entry (2000).

- The digits received by the system (eight maximum)
- The extension the system dials after translation (24 digits maximum)
- The name that should show on the dialed extension display when it rings (12 characters maximum)
- The Transfer Target – 1 and 2
 -  *If the Transfer Targets are busy or receive no answer, those calls are transferred to the final transfer destination (Program 22-10).*
- Operation Mode

Use the following chart when entering and editing text for names. Press the key once for the first character, twice for the second character, etc. For example, to enter a C, press 2 three times.

Key for Entering Names	
When entering names in the procedures below, refer to this chart. Names can have up to 12 digits.	
Use this keypad digit . . .	When you want to . . .
1	Enter characters: 1 @ [¥] ^ _ ` { } → ← Á À Â Ã Ç É Ê ì ó
2	Enter characters: A-C, a-c, 2.
3	Enter characters: D-F, d-f, 3.
4	Enter characters: G-I, g-i, 4.
5	Enter characters: J-L, j-l, 5.
6	Enter characters: M-O, m-o, 6.
7	Enter characters: P-S, p-s, 7.
8	Enter characters: T-V, t-v, 8.
9	Enter characters: W-Z, w-z, 9.

Key for Entering Names	
When entering names in the procedures below, refer to this chart. Names can have up to 12 digits.	
Use this keypad digit . . .	When you want to . . .
0	Enter characters: 0 ! " # \$ % & ' () ô õ ú ä ö ü α ε θ
*	Enter characters: * + , - . / : ; < = > ? π Σ σ Ω □ ϕ £
#	# = Accepts an entry (only required if two letters on the same key are needed - ex: TOM). Pressing # again = Space. (In system programming mode, use the right arrow soft key instead to accept and/or add a space.)
CONF	Clear the character entry one character at a time.
HOLD	Clear all the entries from the point of the flashing cursor and to the right.

Input Data

Conversion Table Number	1~2000
-------------------------	--------

Item No.	Item	Input Data	Default
01	Received Number This is the received DID digits.	Maximum eight digits	No Setting
02	Target Number Enter the destination number to which the DID number is sent.	Maximum 24 digits	No Setting
03	DID Name Enter the name that is assigned to the DID digits when it rings the extension.	Maximum 12 characters	No Setting
04	Transfer Operation Mode	0 = No Transfer 1 = Busy 2 = No Answer 3 = Busy/No Answer	0

Item No.	Item	Input Data	Default
05	Transfer Destination Number 1	0 = No Setting	0
06	<p>Transfer Destination Number 2</p> <p>400 – Allow the outside party to dial a different extension number in the translation table (for example, ring no answer to a dialed number, the caller then hears a dial tone, allowing them to enter another Valid Extension Number).</p> <p>401– Provide the caller with DISA dialing options (requires using the DISA password).</p> <p> This applies to 22-11-05 and 22-11-06.</p>	<p>1~100 = Incoming Group</p> <p>102 = In-Skin/External Voice Mail or InMail</p> <p>201~264 = Extension Group</p> <p>400 = Valid Extension Number</p> <p>401 = DISA</p> <p>501~599 = DISA/VRS Message</p> <p>1000~1999 = Speed Dial Number (000~999)</p>	0
07	<p>Call Waiting</p> <p>PRG 20-09-07 overrides this setting.</p>	<p>0 = Disable (No)</p> <p>1 = Enable (Yes)</p>	0
08	Maximum Number of DID Calls	0~200 (0 = No Limit)	0
09	Music on Hold Source	<p>0 = IC/MOH Port</p> <p>1 = BGM Port</p> <p>2 = ACI Port</p>	0
10	ACI Music Source Port	When a sound source type is 2 in above : (0~96)	0
11	<p>Ring Group Transfer</p> <p>Enable/Disable each conversation table ability to follow the Ring Group programming defined in Program 22-12-01 : DID Intercept Ring Group.</p> <p>If Program 22-11-05 : DID Translation Number Conversion, Transfer Destination Number 1 and Program 22-11-06 : DID Translation Number Conversion, Transfer Destination Number 2 are set, the priority of transferring is in this order: Program 22-11-05 then Program 22-11-06 then if Program 22-11-11 is enabled, Program 22-12-01.</p>	<p>0 = Disable (Caller hears Ringback)</p> <p>1 = Enabled (Go to normal ring)</p>	1

Conditions

- When the trunk type is set to 3 (DID) in 22-02-01, the DID Transfer Destination for each DID feature is not supported. This feature is supported only for DID trunks when assigned as VRS.

Feature Cross Reference

- Direct Inward Dialing (DID)

Program 22 : Incoming Call Setup

22-12 : DID Intercept Ring Group

Level:
IN

Description

For each DID Translation Table, use **Program 22-12 : DID Intercept Ring Group** to define the first destination group for DID calls.

Depending on the entry in Program 22-09-02 and 22-11-04, the incoming calls route to the first destination group by the following:

- Vacant number intercept (vacant number means that no phone is connected, no station blade is installed, or the extension number is not defined in Program 11-02)
- Busy intercept
- Ring-no-answer intercept

If the destination is 0, the calls are forwarded to the trunk ring group defined in Program 22-11 based on the table assigned to the DID trunk.

 ***If Programs 22-11-05 and 22-11-06 are set, the priority of transferring is in this order:
Program 22-11-05 + Program 22-11-06 + Program 22-12.***

For busy and no-answer calls, if the first and third destinations are programmed, but the second destination is not, the incoming call goes to the third destination after the first destination. If the first and second destinations are not defined, but the third destination is, the call goes directly to the third destination.

Input Data

Conversion Table Area Number	01~20
------------------------------	-------

Item No.	Day/Night Mode	Incoming Group Number	Default
01	1~8	0 = No Setting 1~100 (Incoming Ring Group) 102 (In-Skin/External Voice Mail or InMail)	1

Conditions

None

Feature Cross Reference

- Direct Inward Dialing (DID)

Program 22 : Incoming Call Setup

22-13 : DID Trunk Group to Translation Table Assignment

Level:
IN

Description

Use **Program 22-13 : DID Trunk Group to Translation Table Assignment** to assign the DID Trunk Groups to DID Translation Tables. DID trunks should be in their own group. If you have more than one type of DID trunk, put each type in a separate Trunk Group. For each Trunk Group, you make a Translation Table entry for each Night Service mode.

Input Data

Trunk Group Number	1~100
--------------------	-------

Item No.	Day/Night Mode	Conversion Table Area Number	Default
01	1~8	0~20 0 = No Setting	1

Conditions

None

Feature Cross Reference

- Direct Inward Dialing (DID)

Program 22 : Incoming Call Setup

22-14 : VRS Delayed Message for IRG

Level:
IN

Description

Use **Program 22-14 : VRS Delayed Message for IRG** (Incoming Group Ring) to define for each incoming ring group the timers, VRS message number and type of tone for VRS Waiting Message.

Input Data

Incoming Ring Group Number	1~100
----------------------------	-------

Item No.	Item	Input Data	Default
01	1st Delayed Message Start Time Time before the VRS Delay Message is played for IRG.	0~64800 (sec)	0
02	1st Delayed Message Number VRS message that is used for the 1st Delayed Message.	0~101 0 = No Message 101 = Fixed Message	0
03	1st Delayed Message Sending Count This is the number of times the 1st Delay Message is played. If set to 0, the 1st Delay Message is not played.	0~255 (time)	0
04	2nd Delayed Message Number VRS message that is used for the 2nd Delayed Message.	0~101 0 = No Message 101 = Fixed Message	0
05	2nd Delayed Message Sending Count This is the number of times the 2nd Delay Message is played. If set to 0, the 2nd Delay Message is not played.	0~255 (time)	0
06	Tone Kind at Message Interval What is heard between the Delay Messages.	0 = Ring Back Tone 1 = MOH Tone 2 = BGM Source	0
07	Disconnect Time After the End of VRS Delayed Message Time, after all 2nd Delay Messages are played, before the caller is disconnected.	0 = No Disconnect 1~64800 Seconds	60

Conditions

None

Feature Cross Reference

None

Program 22 : Incoming Call Setup

22-15 : VRS Delayed Message for Department Group

Level:
IN

Description

Use **Program 22-15 : VRS Delayed Message for Department Group** to define for each Department (Extension) Group the timers, VRS message number and tone kind for VRS Delayed Message. There are 64 available Department Groups.

Input Data

Extension Group Number	01~64
------------------------	-------

Item No.	Item	Input Data	Default
01	1st Delayed Message Start Time Time before the VRS Delay Message is played for Department Group.	0~64800 (sec)	0
02	1st Delayed Message Number VRS message that is used for the 1st Delayed Message.	0~101 0 = No Message 101 = Fixed Message	0
03	1st Delayed Message Sending Count This is the number of times the 1st Delay Message is played. If set to 0, the 1st Delay Message is not played.	0~255 (time)	0
04	2nd Delayed Message Number VRS message that is used for the 2nd Delayed Message.	0~101 0 = No Message 101 = Fixed Message	0
05	2nd Delayed Message Sending Count This is the number of times the 2nd Delay Message is played. If set to 0, the 2nd Delay Message is not played.	0~255 (time)	0
06	Tone Kind at Message Interval What is heard between the Delay Messages.	0 = Ring Back Tone 1 = MOH Tone 2 = BGM Source	0
07	Disconnect Time After the End of VRS Delayed Message Time, after all 2nd Delay Messages are played, before the caller is disconnected.	0 = No Disconnect 1~64800 (sec)	60

Conditions

None

Feature Cross Reference

- Department Group

Program 22 : Incoming Call Setup

22-16 : Private Call Refuse Target Area Setup

Level:**IN**

Description

Use **Program 22-16: Private Call Refuse Target Area Setup** to define Speed Dial group number for Private Call Refuse.

Item No.	Item	Input Data	Default
01	Speed Dial Group Number	0~64	0

Conditions

None

Feature Cross Reference

- Department Group

Program 22 : Incoming Call Setup

22-17 : Dial-In Conversion Table Area Setup for Time Pattern

Level:

IN

Description

Use **Program 22-17: Dial-In Conversion Table Area Setup for Time Pattern** to define Time Zone and Dial-In Conversion Table (Program 22-11) for Time Pattern.

Input Data

Conversion Table Number	01~100
-------------------------	--------

Item No.	Item	Input Data	Default
01	Received Dial	Up to 8 digits	No Setting
02	Start of Time	0000~2359 (Time)	0000
03	End of Time	0000~2359 (Time)	0000
04	Dial-In Conversion Table Number	0~2000	0

Conditions

None

Feature Cross Reference

None

Program 22 : Incoming Call Setup

22-18 : Private Call Assignment Setup

Level:

IN

Description

Use **Program 22-18: Private Call Assignment Setup** to define assignment and incoming ring pattern for Private Calls.

Item No.	Item	Input Data	Default
01	Transfer Mode	0 = Not defined 1 = Internal dial 2 = Incoming Ring Group	0
02	Destination Number	1 = Internal Dial (up to 24 digits) 0~9, *, #, P, R, @ 2 = Incoming Ring Group (0~100)	No Setting
03	Incoming Ring Pattern	0~9 0 = Normal pattern 1~4 = Tone pattern 5~9 = Scale pattern	0

Conditions

None

Feature Cross Reference

None

Program 22 : Incoming Call Setup

22-20 : Flexible Ringing by Caller ID Setup

Level:
IN

Description

Use **Program 22-20: Flexible Ringing by Caller ID Setup** to set flexible ringing by Caller ID per timer pattern mode.

Input Data

Trunk Port Number	01~200
-------------------	--------

Day/Night Mode	01~08
----------------	-------

Item No.	Item	Input Data	Default
01	Flexible Ringing	0 = Disable 1 = Enable	1

Conditions

None

Feature Cross Reference

None

Program 23 : Answer Features Setup

23-02 : Call Pickup Groups

Level:
IN

Program
23

Description

Use **Program 23-02 : Call Pickup Groups** to assign extensions to Call Pickup Groups. This program also lets you assign an extension Call Pickup Group priority. If two extensions in a group are ringing at the same time, Group Call Pickup intercepts the highest priority extension first.

 *There are 64 available Call Pickup Groups.*

Input Data

Extension Number	Maximum 8 digits
------------------	------------------

Item No.	Group Number	Priority	Default	Description	Related Program
01	1~64	1~999	1 – xxx	Assign extensions to Call Pickup Groups other than the extension group set up by a Program 16-02.	11-12-26 11-12-27 11-12-28 15-07-24 15-07-25 15-07-26

Conditions

None

Feature Cross Reference

- Group Call Pickup

Program 23 : Answer Features Setup

23-03 : Universal Answer/Auto Answer

Level:
IN

Description

Use **Program 23-03 : Universal Answer/Auto Answer** to assign trunk routes (set in Program 14-06) to extensions for Universal Answer. If the call ringing the paging system is in an extension assigned route, the user can dial the Universal Answer code (#0) to pick up the call.

You can also use this program to let an extension user automatically answer trunk calls that ring other extensions (not their own). When the user lifts the handset, they automatically answer the ringing calls based on Trunk Group Routing programming (defined in Program 14-06). The extension user ringing calls, however, always have priority over calls ringing other co-worker extensions. Refer to the Line Preference feature in the UNIVERGE SV8100 Features and Specifications Manual for more information.

Make one entry for each Night Service mode.

Input Data

Extension Number	Maximum eight digits
------------------	----------------------

Item No.	Day/Night Mode	Route Table Number	Default	Description	Related Program
01	1~8	0~100	0	Let an extension user automatically answer trunk calls that ring other extensions. When the user lifts the handset, they automatically answer the ringing calls based on Trunk Group Routing programming (defined in Program 14-06).	14-06

Conditions

None

Feature Cross Reference

- Line Preference
- Night Service

Program 23 : Answer Features Setup

23-04 : Ringing Line Preference for Virtual Extensions

Level:
IN

Description

Use **Program 23-04 : Ringing Line Preference for Virtual Extensions** to set the off-hook automatic response priority for calls ringing virtual extension keys on a telephone.

 *There are 256 available Virtual Extension Ports.*

Input Data

Extension Number	Maximum eight digits
------------------	----------------------

Item No.	Order	Extension Group Number	Default	Description	Related Program
01	1~4	00~64 (0 or 00=Don't Care)	00	When an extension has a virtual extension assigned to a Programmable Function Key, this program determines the priority for automatically answering the ringing calls when the handset is lifted. If 0 or 00 is selected, the user can lift the handset to answer a ringing call from any group.	16-02 20-10-08

Conditions

None

Feature Cross Reference

- Call Arrival Keys (CAR)/Secondary Incoming Extensions (SIE)/ Virtual Extensions (VE)

Program 24 : Hold/Transfer Setup

24-01 : System Options for Hold

Level:
IN

Program

24

Description

Use **Program 24-01 : System Options for Hold** to define the system options for the Hold feature.

Input Data

Item No.	Item	Input Data	Default	Related Program
01	Hold Recall Time A call on Hold recalls the extension that placed it on Hold after this time. This time works with the Hold Recall Callback Time (Item 2).	0~64800 (sec)	90	
02	Hold Recall Callback Time A trunk recalling from Hold or Park rings an extension for this time. This time works with Hold Recall Time or Park Hold Time. After this time, the system invokes the Hold recall time again. Cycling between time 01 and 02 and 06 and 07 continues until a user answers the call.	0~64800 (sec)	30	
03	Exclusive Hold Recall Time A call left on Exclusive Hold recalls the extension that placed it on Hold after this time.	0~64800 (sec)	90	
04	Exclusive Hold Recall Callback Time An Exclusive Hold Recall rings an extension for this time. If not picked up, the call goes back on System Hold.	0~64800 (sec)	30	
05	Forced Release of Held Call Depending on the setting of Program 14-01-16, the system disconnects calls on Hold longer than this time.	0~64800 (sec)	1800	14-01-16

Input Data (Continued)

Item No.	Item	Input Data	Default	Related Program
06	Park Hold Time – Normal A call left parked longer than this time recalls the extension that initially parked it.	0~64800 (sec)	90	20-11-19
07	Park Hold Time – Extended (Recall) A call left parked longer than this time recalls the extension that initially parked it.	0~64800 (sec)	300	20-11-19

Conditions

None

Feature Cross Reference

- Hold
- Park

Program 24 : Hold/Transfer Setup

24-02 : System Options for Transfer

Level:
IN

Description

Use **Program 24-02 : System Options for Transfer** to define the system options for the Transfer feature.

Input Data

Item No.	Item	Input Data	Default	Related Program
01	Busy Transfer Enable/Disable extensions to Transfer calls to busy extensions. If disabled, calls transferred to busy extensions recall immediately.	0 = Disable (No) 1 = Enable (Yes)	1	
02	MOH or Ringback on Transferred Calls Enable/Disable MOH on Transfer. If set to 0, a transferred caller hears MOH while their call rings the destination extension. If set to 1, a transferred caller hears ringback while their call rings the destination extension.	0 = Hold Tone 1 = Ring Back Tone	0	20-03-02
03	Delayed Call Forwarding Time If activated at an extension, Delayed Call Forwarding occurs after this time. This also sets the time a Transferred call waits at an extension forwarded to Voice Mail before routing to the called extension mailbox.	0~64800 (sec)	10	
04	Transfer Recall Time An unanswered transferred call recalls to the extension that initially transferred it after this time.	0~64800 (sec)	30	
05	Message Wait Ring Interval Time For single line telephones (SLTs) without message waiting lamps, this is the time between intermittent ringing. If this value is set to 0, the system rings once.	0~64800 (sec)	30	

Input Data (Continued)

Item No.	Item	Input Data	Default	Related Program
07	<p>Trunk-to-Trunk Transfer Release Warning Tone</p> <p>Time starts when a trunk begins talking with another trunk (for example: trunk-to-trunk transfer, outgoing from trunk, Tandem Trunking).</p> <p>When this time expires, a warning tone is heard. If Program 24-02-10 is set, the conversation disconnects after time expires. This time is set again when the external digit timer expires. One of the trunks used must be an analog trunk (or leased line).</p>	0~64800 (sec)	1800	14-01-25 20-28-01 20-28-02 20-28-03 24-02-10
08	Delayed Transfer Time for all Department Groups	0~64800 (sec)	10	11-11-28 11-11-29 15-07-59
09	Two B-Channel Transfer Retry Timer	0~64800 (sec)	10	10-03-16 (PRI)
10	Disconnect Trunk-to-Trunk	0~64800 (sec)	0	14-01-25 20-28-01 20-28-02 20-28-03 24-02-07
11	No Answer Step Transfer	0~64800 (sec)	10	14-01-26
12	No Answer Trunk-to-Trunk Transfer	0~64800 (sec)	0	14-01-26
13	<p>Hook Flash Sending Timer When the System Answers Automatically</p> <p>Time before sending the hook flash for Call Forward Centrex.</p>	0~64800 (sec)	2	

Conditions

None

Feature Cross Reference

- Transfer

Program 24 : Hold/Transfer Setup

24-03 : Park Group

Level:
IN

Description

Use **Program 24-03 : Park Group** to assign an extension to a Park Group. The system allows a total of 64 Park Groups. An extension user can pick up only a call parked in orbit by an extension user in their own group.

Input Data

Extension Number	Maximum eight digits
------------------	----------------------

Item No.	Park Group Number	Default	Description	Related Program
01	1~64	1	Assign an extension to a Park Group. The system allows a total of 64 Park Groups.	15-07-01

Conditions

None

Feature Cross Reference

- Park

Program 24 : Hold/Transfer Setup

24-04 : Automatic Trunk-to-Trunk Transfer Target Setup

Level:
IN

Description

Use **Program 24-04 : Automatic Trunk-to-Trunk Transfer Target Setup** to assign the Speed Dialing number bin which should be used as the destination of the Automatic Trunk-to-Trunk Transfer.

Input Data

Trunk Port Number	001~200
-------------------	---------

Item No.	Day/ Night Mode	Speed Dial Area Number	Default	Description	Related Program
01	1~8	0~1999	1999	The destination telephone number of the Trunk-to-Trunk Transfer uses the number registered into the Speed Dial. Use this program to setup the Speed Dial Bin Number.	11-10-08 13-04 24-05

Conditions

None

Feature Cross Reference

- Call Forwarding, Off-Premise

Program 24 : Hold/Transfer Setup

24-05 : Department Group Transfer Target Setup

Level:

IN

Description

Use **Program 24-05 : Department Group Transfer Target Setup** to assign the Speed Dialing bin which is used as the destination of the extension for the Extension Group.

 *There are 64 available Department Groups.*

Input Data

Extension Group Number	01~64
------------------------	-------

Item No.	Day/Night Mode	Speed Dial Area Number	Default	Description	Related Program
01	1~8	0~1999	1999	Use the Speed Dialing area to program the destination number of the transferred telephone number when a Department Group call is transferred using the Trunk-to-Trunk Forwarding feature.	11-11-27 13-04 24-04

Conditions

None

Feature Cross Reference

Transfer

Program 24 : Hold/Transfer Setup

24-06 : Fixed Call Forwarding

Level:
IN

Description

For each extension/virtual extension port, use **Program 24-06 : Fixed Call Forwarding** to assign the Fixed Call Forwarding Type (0~4) and the destination extension/virtual extension. For *extension ports*, the Fixed Call Forwarding destination can be an on- or off-premise extension or a Voice Mail extension. For *virtual extensions*, the Fixed Call Forwarding destination can be an on-premise extension or Voice Mail extension.

Input Data

Extension Number	Up to eight digits
------------------	--------------------

Fixed Call Forwarding Type	Default	Description
0 = Fixed Call Forwarding disabled 1 = Fixed Call Forwarding with both extensions ringing 2 = Fixed Call Forwarding when unanswered 3 = Fixed Call Forwarding Immediate 4 = Fixed Call Forwarding when busy or unanswered	0	Set the type of substitute call receipt and specify the extension number transferred on originated telephone.

Conditions

- Do not use Fixed Call Forwarding Type 1 (Both Ringing) with Voice Mail ports.

Feature Cross Reference

- Call Forwarding

Program 24 : Hold/Transfer Setup

24-07 : Fixed Call Forward Off-Premise

Level:

IN

Description

Use **Program 24-07 : Fixed Call Forward Off-Premise** to assign the Fixed Call Forwarding Off-Premise telephone number for each extension/virtual extension. The Off-Premise destination can have up to 24-digits. A trunk access code (e.g., 9) must be included in the number.

Fixed Call Forwarding Types:

Input Data

Extension Number	Up to eight digits
------------------	--------------------

Off-Premise Destination Number	Default
1~9, 0, #, *, P, R, @ (up to 24 digits)	No Setting

Conditions

None

Feature Cross Reference

None

Program 24 : Hold/Transfer Setup

24-08 : Call Forward for Centrex

Level:
IN

Description

Use **Program 24-08 : Call Forward for Centrex** to assign the Call Forwarding type and Call Forwarding for Centrex telephone number for each extension/virtual extension. The Off-Premise destination can have up to 24-digits.

Input Data

Extension Number	Up to eight digits
------------------	--------------------

Item No.	Item	Input Data	Default
01	Call Forwarding Type Set the Call Forwarding type: 0 = Call Forwarding disabled 1 = Call Forwarding No Answer 2 = Call Forwarding Immediate Call 3 = Call Forwarding Busy or No Answer 4 = Call Forwarding when Busy	0~4	0
02	Call Forwarding Destination for Immediate and No Answer Call Set Call Forwarding destination for Centrex for Immediate and No Answer Calls.	1~9, 0, #, *, P, R, @ (up to 24 digits)	No Setting
03	Call Forwarding Busy Destination Set Call Forwarding destination for Centrex for Busy Call.	1~9, 0, #, *, P, R, @ (up to 24 digits)	No Setting

Conditions

None

Feature Cross Reference

None

Program 24 : Hold/Transfer Setup

24-09 : Call Forward Split Settings

Level:

IN

Description

Use **Program 24-09 : Call Forward Split Settings** to assign Call Forwarding Type and the destination number for each extension/virtual extension. The destination can have up to 24 digits, using 0~9, *, #, and @. Be sure to include the trunk access code (e.g., 9) in the number if the destination is off-premise.

 **Only ISDN uses the @ symbol.**

 **Pause can be set by LK 1.**

Input Data

Extension Number	Maximum eight digits
------------------	----------------------

Item No.	Input Data	Default
01	Call Forwarding Type: 0 = Call Forwarding Off 1 = Call Forwarding with both ring 2 = Call Forwarding when no answer 3 = Call Forwarding all calls 4 = Call Forwarding busy or no answer 5 = Call Forwarding when busy	0
02	CO Call Forwarding Destination for Both Ring, All Call, No Answer: 1~9, 0, #, *, R, @ (Up to 24 digits)  <i>Only ISDN uses the @ symbol.</i>	No Setting
03	Intercom Call Forwarding Destination for Both ring, All Call, No Answer: 1~9, 0, #, *, R, @ (Up to 24 digits)	No Setting
04	CO Call Forwarding Busy Destination: 1~9, 0, #, *, R, @ (Up to 24 digits)	No Setting
05	Intercom Call Forwarding Busy Destination: 1~9, 0, #, *, R, @ (Up to 24 digits)	No Setting

Item No.	Input Data	Default
06	Call Forwarding Destination for CTX/PBX for All Call, No Answer: 0~9, #, *, R, @ (Up to 24 digits)	None
07	Call Forwarding Destination for CTX/PBX for Busy: 0~9, #, *, R, @ (Up to 24 digits)	None

Conditions

None

Feature Cross Reference

- Call Forwarding, Off-Premise

Program 25 : VRS/DISA Setup

25-01 : VRS/DISA Line Basic Data Setup

Level:
IN

Program

25

Description

Use **Program 25-01 : VRS/DISA Line Basic Data Setup** to define the basic setting of each VRS/DISA line.

Input Data

Trunk Port Number	001~200
-------------------	---------

Item No.	Item	Input Data	Default	Related Program
01	VRS/DISA Dial-In Mode	0 = Extension Number Service Code Specify (Intercom) 1 = Use Dial Conversion Table	0	22-11
02	DISA User ID	0 = Off 1 = On	1	25-08
03	VRS/DISA Transfer Alarm	0 = Normal (Off) 1 = Alarm (On)	0	

Conditions

None

Feature Cross Reference

- Direct Inward System Access (DISA)

Program 25 : VRS/DISA Setup

25-02 : DID/DISA VRS Message

Level:
IN

Description

Use **Program 25-02 : DID/DISA VRS Message** to assign the VRS message number to be used as the Automated Attendant Message for each trunk which is assigned as a VRS/DISA.

Input Data

Trunk Port Number	001~200
-------------------	---------

Item No.	Day/Night Mode	Message (Talkie) Source	Additional Data	Default
01	1~8	0 = No Message 1 = VRS 2 = ACI 3 = Department Group	1 = 01~100 (VRS Message Number) 2 = 01~04 (ACI Group Number) 3 = 01~64 (Extension Group Number)	0

Conditions

None

Feature Cross Reference

- Direct Inward System Access (DISA)

Program 25 : VRS/DISA Setup

25-03 : VRS/DISA Transfer Ring Group With Incorrect Dialing

Level:

IN

Description

Use **Program 25-03 : VRS/DISA Transfer Ring Group With Incorrect Dialing** to set what happens to a call when the DISA or Automated Attendant caller dials incorrectly or waits too long to dial. The call can either disconnect (0) or Transfer to an alternate destination (a ring group or voice mail). When setting the DISA and DID Operating Mode, make an entry for each Night Service mode.

Input Data

Trunk Port Number	001~200
-------------------	---------

Item No.	Day/Night Mode	Incoming Group Number	Default	Related Program
01	1~8	0 = Disconnect 1~100 (Incoming Ring Group) 102 (In-Skin/External Voice Mail or VM8000 InMail) 104 (Speed Dial Bin)	0	22-04

Conditions

None

Feature Cross Reference

- Direct Inward System Access (DISA)

Program 25 : VRS/DISA Setup

25-04 : VRS/DISA Transfer Ring Group With No Answer/Busy

Level:
IN

Description

Use **Program 25-04 : VRS/DISA Transfer Ring Group With No Answer/Busy** to set the operating mode of each DISA trunk. This sets what happens to the call when the DISA or Automated Attendant caller calls a busy or unanswered extension. The call can either disconnect (0) or Transfer to an alternate destination (a ring group or voice mail). When setting the DISA and DID Operating Mode, make an entry for each Night Service mode.

Input Data

Trunk Port Number	001~200
-------------------	---------

Item No.	Day/Night Mode	Incoming Group Number	Default	Related Program
01	1~8	0 = Disconnect 1~100 (Incoming Ring Group) 102 (In-Skin/External Voice Mail or VM8000 InMail) 104 (Speed Dial Bin)	0	22-04

Conditions

None

Feature Cross Reference

- Direct Inward System Access (DISA)

Program 25 : VRS/DISA Setup

25-05 : VRS/DISA Error Message Assignment

Level:

IN

Description

Use **Program 25-05 : VRS/DISA Error Message Assignment** to assign the VRS message number to be used as the Automated Attendant error message. For each VRS/DISA trunk that the VRS answers, enter the VRS message (1~100) the outside caller hears if they dial incorrectly. If you enter 0 (i.e., no error message), the call reroutes according to Program 25-03 and 25-04.

For each trunk, make a separate entry for each Night Service mode.

Input Data

Trunk Port Number	001~200
-------------------	---------

Item No.	Day/Night Mode	VRS Message Number	Default
01	1~8	0~100 0 = No Setting	0

Conditions

None

Feature Cross Reference

- Direct Inward System Access (DISA)

Program 25 : VRS/DISA Setup

25-06 : VRS/DISA One-Digit Code Attendant Setup

Level:
IN

Description

Use **Program 25-06 : VRS/DISA One-Digit Code Attendant Setup** to set up single digit dialing through the VRS. This gives VRS callers single key access to extensions, the company operator, Department Calling Groups and Voice Mail. For each VRS message set to answer outside calls (refer to Program 25-04 and 25-05), you specify:

- The digit the VRS caller dials (0~9, *, #). Keep in mind that if you assign destinations to digits, outside callers cannot dial system extensions.
- The destination reached (eight digits max.) when the caller dials the specified digit.

The destination can be an extension, a Department Calling pilot number or the Voice Mail master number. A one-digit code can be assigned for each Automated Attendant message.

Example:

Message Number=01, Destination=2, Next Message Number=0, Dial=399

In this example, when 2 is dialed by an outside caller, the system transfers the call to 399. This means that extension 200~299 cannot receive calls from VRS/DISA users during/after VRS Message 01.

Input Data

Attendant Message Number	01~100
--------------------------	--------

Received Dial	1~9, 0, *, #
---------------	--------------

Item No.	Item	Input Data	Default
01	Next Attendant Message Number	0~100 0 = No Setting 101 = Voice Mail answers 104 = Refer to 25-04 : VRS/DISA Transfer Ring Group With No Answer/Busy 105 = Dial the other extension	0
02	Destination Number	Up to eight digits	No Setting

Conditions

- Outside caller may not be able to dial individual extensions or lines if the same first digit is defined here.

Feature Cross Reference

- Direct Inward System Access (DISA)
- Voice Response System (VRS)

Program 25 : VRS/DISA Setup

25-07 : System Timers for VRS/DISA

Level:
IN

Description

Use **Program 25-07 : System Timers for VRS/DISA** to set the value for the system timers which affect DID and DISA. Refer to the following chart for a description of each option, its range and default setting.

Input Data

Item No.	Item	Input Data	Default	Related Program
01	VRS/DISA Dial Tone Time After answering a DISA trunk, the system waits this time for the caller to dial the first digit of the DISA password. If the caller fails to dial during this time, the system drops the call.	0~64800 (sec)	10	25-04
02	VRS/DISA No Answer Time A VRS/DISA caller can ring an extension for this time before the system sets the call as a Ring No Answer. After this time expires, the call follows the programmed Ring No Answer routing (set in Program 25-03 and 25-04).	0~64800 (sec)	0	25-04
03	Disconnect after VRS/DISA retransfer to IRG From DISA trunk, when the call may go to Incoming Ring Group of PRG25-03/25-04. This setting determines the time the call is ringing in the IRG.	0~64800 (sec)	60	
04	Calling Time to Automatic Answering Telephone Set Set the answering waiting time of the automatic answering extension when an incoming DID trunk call is received.	0~64800 (sec)	10	
05	Duration Time for Guidance Message by Automatic Answering Telephone Set Set the announcement time of the automatic answering extension after which an incoming DID trunk caller is disconnected.	0~64800 (sec)	10	
06	Duration Time for Guidance Message by ACI Set the announcement time by the ACI after which an incoming DID trunk caller is disconnected.	0~64800 (sec)	10	

Input Data

Item No.	Item	Input Data	Default	Related Program
07	Long Conversation Warning Tone Time Determine the time a DISA caller or any trunk-to-trunk (such as Tandem Trunking) conversation can talk before the Long Conversation tone is heard.	0~64800 (sec)	3600	14-01-25 20-28-01 20-28-02 20-28-03
08	Long Conversation Disconnect Time Determine the time the system waits before disconnecting a DISA caller or any trunk-to-trunk (such as Tandem Trunking) conversation call after the Long Conversation tone is heard.	0~64800 (sec)	10	14-01-25 20-28-01 20-28-02 20-28-03
09	DISA Internal Paging Time Enter the maximum length of an Internal Page placed by a DISA caller. If the Page continues longer than this time, the system terminates the DISA call.	0~64800 (sec)	30	
10	DISA External Paging Time Enter the maximum length of an External Page placed by a DISA caller. If the Page continues longer than this time, the system terminates the DISA call.	0~64800 (sec)	30	
11	VRS/DISA Answer Delay Time Set up the time the system waits after receiving an incoming VRS/DISA call before the system automatically answers the call.	0~64800 (sec)	0	
13	VRS/DISA Busy Tone Interval If a DISA caller dials a busy extension (and Program 25-04 = 0), the system plays busy tone for this time before disconnecting.	0~64800 (sec)	5	
14	Delayed VRS Answer Time Assign the delay time from switching from a normal incoming status to DID mode. If this time is set to 0, the call switches to DID mode immediately.	0~64800 (sec)	10	

Conditions

None

Feature Cross Reference

- Direct Inward System Access (DISA)

Program 25 : VRS/DISA Setup

25-08 : DISA User ID Setup

Level:
SA

Description

Use **Program 25-08 : DISA User ID Setup** to set the 6-digit DISA password for each user. There are 15 users each with one 6-digit password.

Input Data

DISA User Number	1~15
------------------	------

Item No.	Password	Default	Related PRG
01	Dial (Fixed – six digits) 0~9, *, #	No Setting	49-10-11

Conditions

None

Feature Cross Reference

- Direct Inward System Access (DISA)

Program 25 : VRS/DISA Setup

25-09 : Class of Service for DISA Users

Level:
IN

Description

Use **Program 25-09 : Class of Service for DISA Users** to set the DISA Class of Service for each user. When a DISA caller enters a password (defined in Program 25-08), the system identifies the user and associates the appropriate DISA Class of Service with the call. Assign the DISA Class of Service options in Program 20-14. When programming DISA Class of Service, make one entry for each Night Service mode.

Input Data

DISA User Number	1~15
------------------	------

Item No.	Day/Night Mode	Function Class	Default
01	1~8	1~15	1

Conditions

- DISA Class of Service cannot be 0.
- Program 20-06 cannot be used to assign Class of Service to DISA trunks.

Feature Cross Reference

- Direct Inward System Access (DISA)

Program 25 : VRS/DISA Setup

25-10 : Trunk Group Routing for DISA

Level:
IN

Description

Use **Program 25-10 : Trunk Group Routing for DISA** to assign the Trunk Group route chosen when a user places a DISA call to the system and dials 9. Set Trunk Group Routing in Program 14-06. Enable or disable the DISA caller ability to dial 9 in Program 20-14-02. Assign a route to each DISA Class of Service (1~15). The system assigns a DISA Class of Service to a call based on the password the DISA caller dials.

When programming, make a separate entry for each Night Service Mode.

Input Data

DISA User Number	1~15
------------------	------

Item No.	Day/Night Mode	Route Table Number	Default
01	1~8	0~100 0 = No Setting	1

Conditions

None

Feature Cross Reference

- Direct Inward System Access (DISA)

Program 25 : VRS/DISA Setup

25-11 : DISA Toll Restriction Class

Level:
IN

Description

For systems that use Toll Restriction, use **Program 25-11 : DISA Toll Restriction Class** to assign a Toll Restriction Class (1-15) to each DISA user (1~15). The system uses the Toll Restriction Class you enter in Program 21-05 and 21-06. The Toll Restriction Class assigned to a DISA call is based on the DISA Class of Service and user, which is determined by the password the caller dials.

When programming, make a separate entry for each Night Service mode.

Input Data

DISA User Number	1~15
------------------	------

Item No.	Day/Night Mode	Toll Restriction Class	Default
01	1~8	1~15	2

Conditions

- Program 21-05 cannot be used to assign Toll Restriction to DISA trunks.

Feature Cross Reference

- Direct Inward System Access (DISA)

Program 25 : VRS/DISA Setup

25-12 : Alternate Trunk Group Routing for DISA

Level:
IN

Description

Use **Program 25-12 : Alternate Trunk Group Routing for DISA** to define the trunk route selected when a DISA caller dials the Alternate Trunk Access Code. The route selected is based on the DISA caller Class of Service, which in turn is determined by the password the caller dials. When programming, make a separate entry for each Night Service Mode.

Use Program 11-09-02 to set the Alternate Trunk Access Code. Use Program 14-06 to set trunk routes.

Input Data

DISA User Number	1~15
------------------	------

Item No.	Day/Night Mode	Route Table Number	Default
01	1~8	0~100 0 = No Setting	1

Conditions

- You cannot use Program 21-15 to assign alternate trunk routing to DISA trunks.

Feature Cross Reference

- Direct Inward System Access (DISA)
- Trunk Group Routing

Program 25 : VRS/DISA Setup

25-13 : System Option for DISA

Level:
IN

Description

Use **Program 25-13 : System Option for DISA** to enter the password DISA callers must dial before the system allows them to record, listen to and or erase the VRS messages. This program also is used to define additional DISA call options.

Input Data

Item No.	Item	Input Data	Default
01	VRS Message Access Password Enter the password DISA callers must dial before the system allows them to record, listen to and/or erase the VRS messages.	1~ 9, 0, *, # (Fixed six digits)	No Setting

Conditions

None

Feature Cross Reference

- Direct Inward System Access (DISA)
- Voice Response System (VRS)

Program 25 : VRS/DISA Setup

25-15 : DISA Transfer Target Setup

Level:
IN

Description

Use **Program 25-15 : DISA Transfer Target Setup** to assign a Speed Dial number when a dial tone times-out, or when the wrong number is received and the target extension does not answer or is busy.

Input Data

Item No.	Item	Input Data	Default
01	DISA Transfer Target Area At Wrong Dial	Speed Dial bin number 0~1999	1999
02	DISA Transfer Target Area At No Answer or Busy	Speed Dial bin number 0~1999	1999

Conditions

- Related to Program 25-03-01 and Program 25-04-01.

Feature Cross Reference

- Direct Inward System Access (DISA)
- Voice Response System (VRS)

THIS PAGE INTENTIONALLY LEFT BLANK

Program 26 : ARS Service

26-01 : Automatic Route Selection Service

Level:
IN

Description

Use **Program 26-01 : Automatic Route Selection Service** to define the system options for Automatic Route Selection (ARS).

Input Data

Item No.	Item	Input Data	Default	Related Programming
01	ARS Service Enable/Disable ARS.	0 = Disable (Off) 1 = Enable (On)	0	26-02 26-03 26-04
02	Network Outgoing InterDigit ARS Time With Networking, this time replaces 20-03-04 when determining if all network protocol digits have been received. If ARS is enabled at Site B, this time can be programmed for 5 (500ms) at Site A. If ARS is disabled and Site B is using F-Route for outbound dialing, this time should be programmed for 30 (three seconds) at Site A.	0~64800 (sec) (in 0.1 second increments)	30	20-03-04
03	ARS Misdialed Number Handling If a user dials a number not programmed in ARS, this option determines if the system should route over Trunk Group 1 or play error tone.	0 = Route to Trunk Group 1 1 = Play Warning Tone to Dialer	0	21-02
06	Class of Service Match Access	0 = Disable (Off) 1 = Enable (On)	0	26-02
07	F-Route Access COS Reference	0 = F-Route 1 = ARS	0	26-02 44-05

Program

26

Conditions

None

Feature Cross Reference

- Automatic Route Selection

Program 26 : ARS Service

26-02 : Dial Analysis Table for ARS/LCR

Level:

IN

Description

Use **Program 26-02 : Dial Analysis Table for ARS/LCR** to set pre-transaction tables for selecting Automatic Route Selection (ARS).

- Service Type 1 (Route to Trunk Group Number) – The number routes to a trunk group.
- Service Type 2 (F-Route Selected) – The number is controlled by the F-Route table.

Input Data

Dial Analysis Table Number	1~400
----------------------------	-------

Item No.	Item	Input Data	Default	Related Programming
01	Dial	Dial Digits (16 digits maximum) 1~9, 0, *, #, or for wild character (Press line key 1)	No Setting	
02	ARS Service Type	0 = No Service (None) 1 = Route to Trunk Group 2 = Select F-Route Access	0	
03	Additional Data / Service Number	If Service Type 1 (in 26-02): Select Trunk Group Number (0~100, 0= No Route) If Service Type 2 (in 26-02): F-Route Time Schedule Not Used = 0~500 (F-Route Table Number). Refer to Program 44-05 : ARS/F-Route Table on page 2-481 . F-Route Time Schedule Used = 0~500 (F-Route Selection Number). Refer to Program 44-04 : ARS/F-Route Selection for Time Schedule on page 2-480 .	0	44-04 44-05
04	ARS Class of Service	0~16	0	
05	Dial Treatment for ARS	0~15	0	
06	--- Not Used ---			

Item No.	Item	Input Data	Default	Related Programming
07	Network Specified Parameter Table	0~16	0	26-12

Conditions

None

Feature Cross Reference

- Automatic Route Selection



Program 26 : ARS Service

26-03 : ARS Dial Treatments

Level:
IN

Description

Use **Program 26-03 : ARS Dial Treatments** to assign the 15 Dial Treatments for automatic ARS dialing translation. Assign Dial Treatments to Service Numbers (Trunk Groups) in Program 26-02. The ARS Dial Treatment options are:

- 3** – Delete the NPA if dialed as part of the initial call.
 *Requires at least 11 digits in the ARS table (Program 26-02-01).*
- 2** – Delete the leading digit if dialed as part of the initial call.
 *Requires at least eight digits in the ARS table (Program 26-02-01).*
- 1** – Add a leading 1 if not dialed as part of the initial call.
 *Requires at least eight digits in the ARS table (Program 26-02-01).*
- INPA** – Insert the NPA specified by NPA.
- An** – For Alternate Carrier Access (n = 1~4). The numeric digit instructs the system to insert a Transit Network Selection information element in the SETUP message and also identifies which code in Program 26-11 will be included in the information element. This function is valid only for outbound calls by ISDN trunks.
- DNN** – Outdial the NN number of digits or execute the code that follows. For example, D041234 outdials 1234. Valid entries are 0~9, #, *, Wnn (wait nn seconds) and P (pause). Each digit's code counts as a digit. So, for example, if a P was added for a pause, the entry would look like: **D05P1234**.
- Wnn** – Wait nn seconds.
- P** – Pause in analog trunk.
- R** – Redial the initially dialed number, including any modifications.
- E** – End of Dial Treatment. All Dial Treatments must end with the E code.
- X** – When ARS is enabled, X must be entered in the Dial Treatment for the system to output the extension number of the call originator to the black box for the E911 feature.

Input Data

Dial Treatment Table Number	1~15
-----------------------------	------

Item No.	Item	Input Data	Default
01	Treatment Code	24 characters maximum	No Setting

Conditions

None

Feature Cross Reference

- Automatic Route Selection

Program 26 : ARS Service

26-04 : ARS Class of Service

Level:
IN

Description

Use **Program 26-04 : ARS Class of Service** to set the ARS Class of Service for an extension. Automatic Route Selection uses ARS Class of Service when determining how to route extension calls.

Input Data

Extension Number	Up to eight digits
------------------	--------------------

Item No.	Day/Night Mode	Class	Default
01	1~8	0~16	0

Conditions

None

Feature Cross Reference

- Automatic Route Selection

Program 26 : ARS Service

26-11 : Transit Network ID Table

Level:
IN

Description

Use **Program 26-11 : Transit Network ID Table** to define Transit Network ID for Alternate carrier access, which is referred from Program 26-03.

Input Data

Transit Network ID Table	1~4
--------------------------	-----

Item No.	Item	Input Data	Default
01	Transit Network ID (Carrier ID)	0000~9999 (Fixed four digits)	No setting

Conditions

None

Feature Cross Reference

None

Program 26 : ARS Service

26-12 : Network Specific Parameter Table for ARS

Level:

IN

Description

Use **Program 26-12 : Network Specific Parameter Table for ARS** to define the Network Specific Parameter Table.

Input Data

Network Specific Parameter Table	1~16
----------------------------------	------

Item No.	Item	Input Data	Default
01	Type of Number Selection This setting is used by Program 26-02-07 and Program 44-05-11 to determine ISDN element.	0 = System Default 1 = Unknown 2 = International No. 3 = National No. 4 = Network Specific No. 5 = Subscriber No. 6 = Abbreviated No.	0
02	Numbering Plan Identification Selection This setting is used by Program 26-02-07 and Program 44-05-11 to determine ISDN element.	0 = System Default 1 = Unknown 2 = ISDN Plan 3 = Data Plan 4 = Telex Plan 5 = National Standard Plan 6 = Private Plan	0

Conditions

None

Feature Cross Reference

None

THIS PAGE INTENTIONALLY LEFT BLANK

Program 30 : DSS/DLS Console Setup

30-01 : DSS Console Operating Mode

Level:
IN

Program

30

Description

Use **Program 30-01 : DSS Console Operating Mode** to set the mode of the system DSS Consoles. The entry for this option applies to all the system DSS Consoles. The available options are:

- Regular (Business) Mode (0)
- Hotel Mode (1)
- ACD Monitor Mode (2)
- Business/ACD Mode (3)

Input Data

DSS Console Number	01~32
--------------------	-------

Item No.	DSS Operation Mode	Default
01	0 = Business Mode 1 = Hotel Mode 2 = ACD Monitor Mode 3 = Business/ACD Mode	0

Conditions

None

Feature Cross Reference

- Direct Station Selection (DSS) Console
- Hotel/Motel

Program 30 : DSS/DLS Console Setup

30-02 : DSS Console Extension Assignment

Level:
IN

Description

Use **Program 30-02 : DSS Console Extension Assignment** to identify which extensions have DSS Consoles connected.

- Up to 32 different extensions with DSS Consoles can be set up. A single extension can have up to four 60-button DSS Consoles (32 is the maximum allowed per system).

When programming, each extension/DSS Console(s) combination is called a Console Number. There are 32 Console Numbers (1~32). Console Numbers can be assigned to extensions. When entering data, the assignment for Console Number 1 is normally made first.

Input Data

60-button DSS Console Number	01~32
------------------------------	-------

Item No.	Item	Default
01	Extension Number Enter the extension number for the multiline terminal connected with the DSS console (up to eight digits).	No Setting

Conditions

None

Feature Cross Reference

- Direct Station Selection (DSS) Console

Program 30 : DSS/DLS Console Setup

30-03 : DSS Console Key Assignment

Level:
SA

Description

Use **Program 30-03 : DSS Console Key Assignment** to customize the key assignments for 60-button DSS Consoles. A DSS Console key can have any function with up to four digits (e.g., extension number or Service Code).

To prevent lamp problems when reassigning DSS Console keys, clearing an extension programmed key before reassigning it is recommended [Enter key to be cleared + 00 or *00 (If using WebPro or PC Programming, delete the key assignments and upload the change to the system before proceeding.)] Without clearing an extension key first, the DSS Console may not show the correct lamp display, although the DSS function works correctly.

If you are programming the system from the extension to which the DSS Console is connected, either by phone or using the WebPro or PC Program, you may need to unplug the DSS and plug it back in to reset the console lamping.

Input Data

Index 1

DSS Console Number	01~32
--------------------	-------

Index 2

Item No.	Key Number	Function Number	Additional Data
01	001~114	0~99 (General Functional Level) 97 = Door Box Access key (additional data: 1~8 Door Box No.) * 00 ~ * 99 (Appearance Functional Level)	Refer to Function Number List on the following pages.

Function Number List
[1] General functional level (00~99)

Function Number	Function	Additional Data	LED Indication
00	--- Not Used ---		
01	DSS/One-Touch	Extension Number or any Numbers (up to 24 digits)	Red On: Extension Busy Off: Extension Idle Rapid Blink (Red): DND or Call Forward
02	Microphone Key (ON/OFF)		Red On: Mic On Off: Mic Off
03	DND Key		Red On: DND
04	BGM (ON/OFF)		Red On: BGM On Off: BGM Off
05	Headset		Red On: Under Headset Operation
06	Transfer Key		None
07	Conference Key		Red On: Under Conference Operation
08	Incoming Call Log		Rapid Blink (Red): New Call Log Red On: Call Log Off: No Call Log
09	Day/Night Mode Switch	Mode Number (1~8)	Red On: On mode
10	Call Forward – Immediate		Slow Blink (Red): Forwarding State Rapid Blink (Red): Forwarded State
11	Call Forward – Busy		Slow Blink (Red): Forwarding State Rapid Blink (Red): Forwarded State
12	Call Forward – No Answer		Slow Blink (Red): Forwarding State Rapid Blink (Red): Forwarded State
13	Call Forward – Busy/No Answer		Slow Blink (Red): Forwarding State Rapid Blink (Red): Forwarded State
14	Call Forward – Both Ring		Slow Blink (Red): Forwarding State Rapid Blink (Red): Forwarded State
15	Follow Me		Slow Blink (Red): Forwarding State Rapid Blink (Red): Forwarded State
18	Text Message Setup	Message Numbers (01~20)	Red On: Feature active by Function Key
19	External Group Paging	External Paging Number (1~8)	Red On: Active

Function Number List (Continued)
[1] General functional level (00~99)

Function Number	Function	Additional Data	LED Indication
20	External All Call Paging		Red On: Active
21	Internal Group Paging	Internal Paging Number (01~64)	Red On: Active
22	Internal All Call Paging		None
23	Meet-Me Answer to Internal Paging		None
24	Call Pickup		None
25	Call Pickup for Another Group		None
26	Call Pickup for Specified Group	Call Pickup Group Number	None
27	Speed Dial – System/ Private	Speed Dial Number (Speed/Private)	None
28	Speed Dial – Group	Speed Dial Number (Group)	None
29	Repeat Redial		Rapid Blink (Red): Under a Repeat Dial
30	Saved Number Redial		None
31	Memo Dial		None
32	Meet – Me Conference		None
33	Override (Off-Hook Signaling)		None
34	Barge-In		None
35	Camp On		Red On: Under Camp-On or Reservation
36	Department Step Call		None
37	DND/FWD Override Call		None
38	Message Waiting		None

Function Number List (Continued)
[1] General functional level (00~99)

Function Number	Function	Additional Data	LED Indication
39	Room Monitoring		Rapid Blink (Red): Under Monitored Slow Blink (Red): Under Monitoring With Room Monitor there are two parties in the monitor, one being monitored and one who is monitoring. The same key is used on both phones, but the COS says if the key is set to be either a monitored or monitoring party.
40	Handset Transmission Cutoff		Red On: Transmission cut-off
41	Secretary Buzzer	Extension Number	Red On: Transmission Side Rapid Blink (Red): Receiver Side
42	Boss – Secretary Call Pickup	Extension Number	Red On: Boss – Secretary Mode
43	Series Call		None
44	Common Hold		None
45	Exclusive Hold		None
46	Department Group Log Out		Red On: Logged Out
47	--- Not Used ---		
48	--- Not Used ---		
49	Call Redirect	Extension Number or Voice Mail Number	None
50	Account Code		None
51	General Purpose Relay	Relay No (0, 1~8)	Red On: Relay On
52	Automatic Answer with Delay Message Setup	Incoming Group Number	Red On: Under Setting
53	Automatic Answer with Delay Message Starting		Red On: Active
54	External Call Forward by Door Box		Red On: Active
55	Extension Name Edit		None
56	General Purpose LED Operation	001~100: (Red)	001~100: Rapid Blink (Red) 101~200: Rapid Blink (Green) 201~300: Red On, Green Rapid Blink

Function Number List (Continued)
[1] General functional level (00~99)

Function Number	Function	Additional Data	LED Indication
57	General Purpose LED Indication		001~100: Rapid Blink (Red) 101~200: Rapid Blink (Green) 201~300: Red On, Green Rapid Blink
58	Department Incoming Call – Immediate	Extension Group Number (01~64)	
59	Department Incoming Call – Delay	Extension Group Number (01~64)	
60	Department Incoming Call – DND	Extension Group Number (01~64)	
61	--- Not Used ---		
63	Outgoing Call Without Caller ID (ISDN)		Red On: Active
64	--- Not Used ---		
65	--- Not Used ---		
66	CTI		Red On: CTI active
67	--- Not Used ---		
68	--- Not Used ---		
69	--- Not Used ---		
70	--- Not Used ---		
71	--- Not Used ---		
72	Keypad Facility Key		
73	Keypad Hold Key		
74	Keypad Retrieve Key		
75	Keypad Conference Key		
76	--- Not Used ---		
77	Voice Mail (In-Skin)	Extension Number or Pilot Number	Red On: Access to Voice Mail Rapid Blink (Green): New Message
78	Conversation Recording	0 = Conversation recording 1 = Delete, Re-recording 2 = Delete	Rapid Blink (Red): Recording
79	Automated Attendant (In-Skin)	Extension Number or Pilot Number	Red On: Set Up for All Calls Slow Blink (Red): Set Up for Busy/No Answer Calls

Function Number List (Continued)
[1] General functional level (00~99)

Function Number	Function	Additional Data	LED Indication
80	Tandem Ringing	0 = Cancel 1 = Set Extension Number to Tandem Ring	Red On: Active
81	Automatic Transfer to Transfer Key	Trunk Line Number 001~200	
82	<i>D^{term}</i> IP Call Log		
83	Conversation Recording Function	0 = Pause 1 = Re-record 2 = Address 3 = Erase 4 = Urgent Page	
92	Wake Up Call Indication		Green On: Wake Up Call Indication Mode On Off: Wake Up Call Indication Mode Off
93	Room Status Indication		Green On: Active Room Status Off: Room Status Indication Mode Off
94	Call Attendant		
95	Page Switching		Red On: DSS Page 1 Green On: DSS Page 2
97	Door Box Access Key	Door Box number (1~8)	
99	Alternate Answer Key		

Function Number List
[2] Appearance Function Level (*00 - *99) (Service Code 752)

Function Number	Function	Additional Data	LED Indication
*00	--- Not Used ---		
*01	Trunk Key	Trunk Number (001~200)	
*02	--- Not Used ---		
*03	--- Not Used ---		

Function Number List (Continued)
[2] Appearance Function Level (*00 - *99) (Service Code 752)

*04	Park Key	Park Number (01~64)	
*05	--- Not Used ---		
*06	Trunk Access Via Networking	Network System Number (01~50)	
*07	Station Park Hold None		
*08	--- Not Used ---		
*10	--- Not Used ---		
*11	--- Not Used ---		
*12	--- Not Used ---		
*13	--- Not Used ---		
*14	--- Not Used ---		
*15	--- Not Used ---		
*16	--- Not Used ---		
*17	--- Not Used ---		
*18	--- Not Used ---		
*19	--- Not Used ---		

Default

- The DSS keys 01~60 of all DSS consoles = DSS/One-Touch key 101~160.
- The DSS keys 61~114 of all DSS consoles = None

Conditions

None

Feature Cross Reference

- Direct Station Selection (DSS) Console

Program 30 : DSS/DLS Console Setup

30-04 : DSS Console Alternate Answer

Level:
SA

Description

Use **Program 30-04 : DSS Console Alternate Answer** to assign the alternate DSS console station in case off-duty mode is set (by pressing the **ALT** key on the DSS console).

Index 1

DSS Console Number	01~32
--------------------	-------

Index 2

Item No.	Item Name	Input Data	Default
01	DSS Console Alternate Answer	Alternate DSS No. 01~32	0 = No Setting

Conditions

- Related extension is assigned in PRG30-02. Alternate answer key (**ALT** key) is assigned at PRG30-03.

Feature Cross Reference

None

Program 30 : DSS/DLS Console Setup

30-05 : DSS Console Lamp Table

Level:
IN

Description

Use **Program 30-05 : DSS Console Lamp Table** to define the LED patterns for functions on the DSS consoles.

Input Data

Item No.	Item	Lamp Pattern Data	Default
02	Busy Extension	0~7	7 (On)
03	DND Extension	0~7	3 (RW)
04	ACD Agent Busy	0~7	7 (On)
05	Out of Schedule (ACD DSS)	0~7	0 (Off)
06	ACD Agent Log Out (ACD DSS)	0~7	5 (IL)
07	ACD Agent Log In (ACD DSS)	0~7	4 (IR)
08	ACD Agent Emergency (ACD DSS)	0~7	6 (IW)
09	Hotel Status Code 1 (Hotel DSS)	0~7	7 (On)
10	Hotel Status Code 2 (Hotel DSS)	0~7	1 (FL)
11	Hotel Status Code 3 (Hotel DSS)	0~7	2 (WK)
12	Hotel Status Code 4 (Hotel DSS)	0~7	3 (RW)
13	Hotel Status Code 5 (Hotel DSS)	0~7	5 (IL)
14	Hotel Status Code 6 (Hotel DSS)	0~7	3 (RW)
15	Hotel Status Code 7 (Hotel DSS)	0~7	6 (IW)
16	Hotel Status Code 8 (Hotel DSS)	0~7	4 (IR)
17	Hotel Status Code 9 (Hotel DSS)	0~7	3 (RW)
18	Hotel Status Code 0 (Hotel DSS)	0~7	0 (Off)
19	Hotel Status Code * (Hotel DSS)	0~7	4 (IR)
20	Hotel Status Code # (Hotel DSS)	0~7	5 (IL)
21	VM Message Indication	0~7	3 (RW)

Table 2-9 LED Patterns for DSS Console

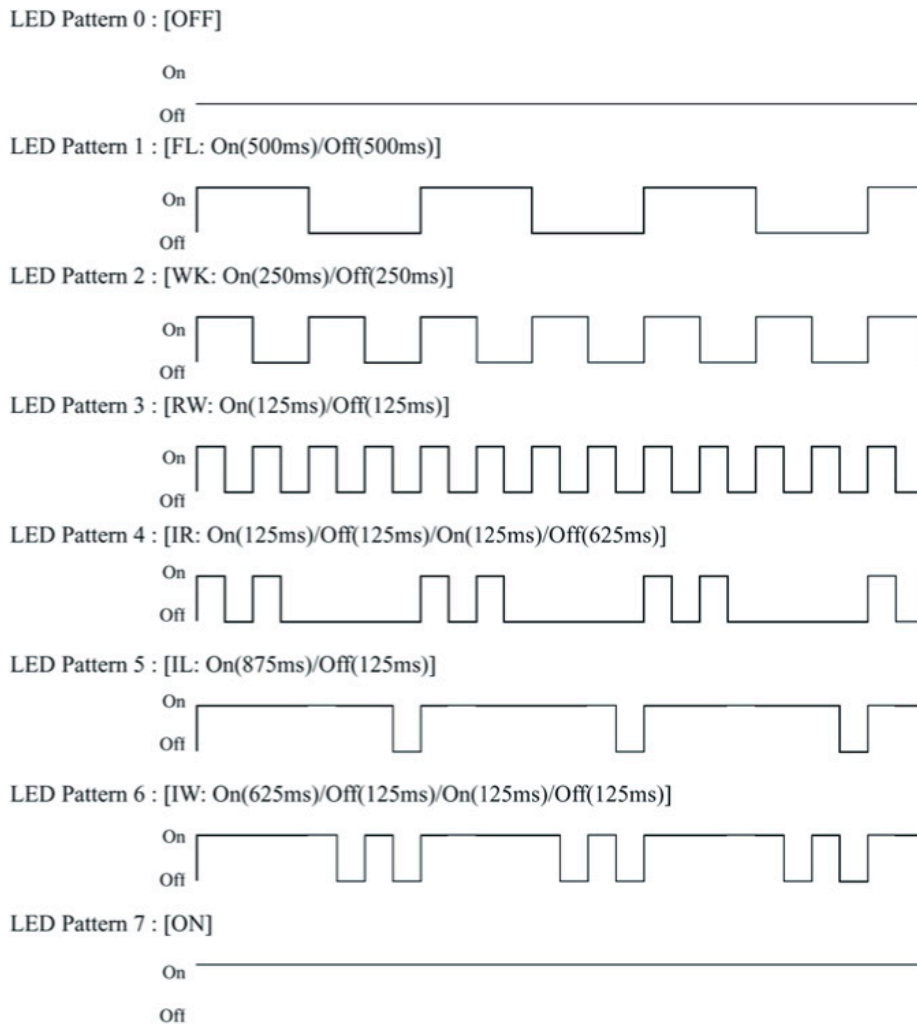

Conditions

None

Feature Cross Reference

- Direct Station Selection (DSS) Console

Program 30 : DSS/DLS Console Setup

30-10 : DSS Console IP Terminal Setup

Level:
SA

Description

Use **Program 30-10 : DSS Console IP Terminal Setup** to set the MAC address for a particular IP DSS Console. This must be done before the console can be associated to the attendant phone. The system supports up to 32 IP DSS Consoles.

Index 1

DSS Console Number	01~32
--------------------	-------

Input Data

Item No.	Function Name	Input Data	Default
01	MAC Address	00-00-00-00-00-00~FF-FF-FF-FF-FF-FF	00-00-00-00-00-00

Conditions

- This is a Read-Only command.

Feature Cross Reference

None

THIS PAGE INTENTIONALLY LEFT BLANK

Program 31 : Paging Setup

31-01 : System Options for Internal/External Paging

Level:
IN

Program
31

Description

Use **Program 31-01 : System Options for Internal/External Paging** to define the system options for Internal/External Paging.

The system shows the name you program on the telephone display. Use the following chart when entering and editing text. When using the keypad digits, press the key once for the first character, twice for the second character, etc. For example, to enter C, press 2 three times. Press 2 six times to display the lower case letter.

Key for Entering Names	
When entering names in the procedures below, refer to this chart. Names can have up to 12 digits.	
Use this keypad digit . . .	When you want to . . .
1	Enter characters: 1 @ [¥] ^ _ ` { } → ← Á À Â Ã Ç É Ê Ì Ó
2	Enter characters: A-C, a-c, 2.
3	Enter characters: D-F, d-f, 3.
4	Enter characters: G-I, g-i, 4.
5	Enter characters: J-L, j-l, 5.
6	Enter characters: M-O, m-o, 6.
7	Enter characters: P-S, p-s, 7.
8	Enter characters: T-V, t-v, 8.
9	Enter characters: W-Z, w-z, 9.
0	Enter characters: 0 ! “ # \$ % & ’ () ô õ ú ä ö ü α ε θ

Key for Entering Names (Continued)	
When entering names in the procedures below, refer to this chart. Names can have up to 12 digits.	
Use this keypad digit . . .	When you want to . . .
*	Enter characters: * + , - . / : ; < = > ? π Σ σ Ω \square ϕ £
#	# = Accepts an entry (only required if two letters on the same key are needed - ex: TOM). Pressing # again = Space. (In system programming mode, use the right arrow soft key instead to accept and/or add a space.)
Conf	Clear the character entry one character at a time.
Hold	Clear all the entries from the point of the flashing cursor and to the right.

Input Data

Item No.	Item	Input Data	Default	Related Program
01	All Call Paging Zone Name Assign a name to each All Call Internal Paging zone. The name shows on the display of the telephone making the announcement.	Up to 12 Characters	Group All	11-12-19 31-02-02
02	Page Announcement Duration Set the maximum time for Page announcements. (Affects External Paging only)	0~64800 (sec)	1200	
04	Privacy Release Time Once the user initiates a Meet-Me Conference or Voice Call Conference, the system waits this time for the Paged party to join the call.	0~64800 (sec)	90	

Conditions

None

Feature Cross Reference

- Paging, External
- Paging, Internal

Program 31 : Paging Setup

31-02 : Internal Paging Group Assignment

Level:
IN

Description

Use **Program 31-02 : Internal Paging Group Assignment** to assign extensions to Internal Paging Groups (i.e., Page Zones). The setting in this program also determines if the Internal Page Group can receive Internal All Call Paging. The system can have up to 64 paging groups. An extension can be in only one Internal Paging Group.

Input Data

Extension Number	Maximum eight digits
------------------	----------------------

Item No.	Item	Input Data	Default
01	Internal Paging Group Number Assign extensions to Internal Paging Groups (i.e., Page Zones). The system allows up to 64 Internal Paging Groups. An extension can be in only one Internal Paging Group.	0~64 (0 = No Setting)	0 for IP Station 1 for TDM Station
02	Internal All Call Paging Receiving Allow/Prevent All Call Internal Paging for each extension. If allowed, extension can place and receive All Call Internal Paging announcements. If prevented, extensions can make only (not receive) All Call Internal Paging announcements. If combined, Paging zones should be restricted as well, change the internal page zone group in Program 31-07-01 to 0.	0 = Off 1 = On	0

Conditions

None

Feature Cross Reference

- Paging, Internal

Program 31 : Paging Setup

31-03 : Internal Paging Group Settings

Level:
IN

Description

Use **Program 31-03 : Internal Paging Group Settings** to assign names to Internal Paging Groups (i.e., Page Zones) and to define the splash tone for Internal Paging.

The system shows the names you program on the telephone display. Use the following chart when entering and editing text. When using the keypad digits, press the key once for the first character, twice for the second character, etc. For example, to enter a C, press 2 three times. Press 2 six times to display the lower case letter.

Key for Entering Names	
When entering names in the procedures below, refer to this chart. Names can have up to 12 digits.	
Use this keypad digit . . .	When you want to . . .
1	Enter characters: 1 @ [¥] ^ _ ` { } → ← Á À Â Ã Ç É Ê Ì Ó
2	Enter characters: A-C, a-c, 2.
3	Enter characters: D-F, d-f, 3.
4	Enter characters: G-I, g-i, 4.
5	Enter characters: J-L, j-l, 5.
6	Enter characters: M-O, m-o, 6.
7	Enter characters: P-S, p-s, 7.
8	Enter characters: T-V, t-v, 8.
9	Enter characters: W-Z, w-z, 9.
0	Enter characters: 0 ! “ # \$ % & ' () ô õ ú ä ö ü α ε θ
*	Enter characters: * + , - . / : ; < = > ? π Σ σ Ω □ ç £

Key for Entering Names	
When entering names in the procedures below, refer to this chart. Names can have up to 12 digits.	
Use this keypad digit . . .	When you want to . . .
#	# = Accepts an entry (only required if two letters on the same key are needed - ex: TOM). Pressing # again = Space. (In system programming mode, use the right arrow soft key instead to accept and/or add a space.)
Conf	Clear the character entry one character at a time.
Hold	Clear all the entries from the point of the flashing cursor and to the right.

Input Data

Internal Paging Group Number	01~64
------------------------------	-------

Item No.	Item	Input Data	Default
01	Internal Paging Group Name Assign name to Internal Paging Groups (i.e., Page Zones). The system shows the name you program on the telephone display.	Up to 12 Characters	Refer to default table.

Default

Item 01 : Internal Paging Group Name

Extension Paging Group	Name
01	Group 1
02	Group 2
:	:
64	Group 64

Conditions

None

Feature Cross Reference

- Paging, Internal

Program 31 : Paging Setup

31-04 : External Paging Zone Group

Level:
IN

Description

Use **Program 31-04 : External Paging Zone Group** to assign each External Paging zone to an External Paging group. Users call the External Paging group when broadcasting announcements to the external zone. When programming, the zones on the PGD(2)-U10 ADP are numbers 1~8. On the UNIVERGE SV8100 system, the CD-CP00-US zone is number 9.

To simplify programming and troubleshooting, always make the External Paging Zone Group the same number as the External Paging zone (i.e., 1 = 1, 2 = 2, etc.).

Input Data

External Speaker Number	1~9
-------------------------	-----

Item No.	Paging Group Number	Default
01	0~8 (0 = No Setting)	Speaker 1 [PGD(2)-U10 ADP] = 1 (Group 1) Speaker 2 [PGD(2)-U10 ADP] = 2 (Group 2) Speaker 3 [PGD(2)-U10 ADP] = 3 (Group 3) Speaker 4 [PGD(2)-U10 ADP] = 4 (Group 4) Speaker 5 [PGD(2)-U10 ADP] = 5 (Group 5) Speaker 6 [PGD(2)-U10 ADP] = 6 (Group 6) Speaker 7 [PGD(2)-U10 ADP] = 7 (Group 7) Speaker 8 [PGD(2)-U10 ADP] = 8 (Group 8) Speaker 9 (CD-CP00-US) = 1 (Group 1)

Conditions

None

Feature Cross Reference

- Paging, External

Program 31 : Paging Setup

31-05 : Universal Night Answer/Ring Over Page

Level:
IN

Description

Use **Program 31-05 : Universal Night Answer/Ring Over Page** to assign Universal Night Answer ringing to each External Paging zone. For each trunk port, make a separate entry for each External Paging zone. When programming, the zones on the PGD(2)-U10 ADP are numbers 1~8. The CD-CP00-US zone is number 9. For UNA ringing, make a separate entry for each Night Service mode.

Input Data

Trunk Port Number	1~200
-------------------	-------

External Speaker Number	1~9
-------------------------	-----

Item No.	Day/Night Mode	Input Data	Default
01	1~8	0 = No Ringing (No) 1 = Ringing (Yes)	0

Conditions

None

Feature Cross Reference

- Night Service
- Paging, External

Program 31 : Paging Setup

31-06 : External Speaker Control

Level:

IN

Description

Use **Program 31-06 : External Speaker Control** to define the settings for the external speaker using an amplifier.

Input Data

External Speaker Number	1~9
-------------------------	-----

Item No.	Item	Input Data	Default
01	Broadcast Splash Tone Before Paging (Paging Start Tone) Enable/Disable splash tone before Paging over an external zone. If enabled, the system broadcasts a splash tone before the External Paging announcement.	0 = No Tone (None) 1 = Splash Tone 2 = Chime Tone	2
02	Broadcast Splash Tone After Paging (Paging End Time) Enable/Disable splash tone after Paging over an external zone. If enabled, the system broadcasts a splash tone at the end of an External Paging announcement.	0 = No Tone (None) 1 = Splash Tone 2 = Chime Tone	2
03	Speech Path Determine if the external speaker is used for talkback (As this option is not available with the CD-CP00-US external page zone, speaker 9 should be left at 1).	0 = Both Way (Duplex) 1 = One Way (PGD(2)-U10 ADP → SPK) (Simplex)	1
04	CODEC Transmit Gain Setup	1~63 (-15.5 ~ +15.5dB)	32
05	CODEC Receive Gain Setup	1~63 (-15.5 ~ +15.5dB)	32

Conditions

None

Feature Cross Reference

- Paging, External

Program 31 : Paging Setup

31-07 : Combined Paging Assignments

Level:

IN

Description

Use **Program 31-07 : Combined Paging Assignments** to assign an External Paging Group (0~8) to an Internal Paging Zone (0~64) for Combined Paging. When an extension user makes a Combined Page, they simultaneously broadcast into both the External and Internal Zone.

Use Program 31-04-01 to assign an External Paging Zone (1~9) to an External Page Group (1~8).

Input Data

External Paging Group Number	0~8 (0 = All External Paging)
------------------------------	-------------------------------

Item No.	Internal Paging Group Number	Default
01	0~64 (0 = All Internal Paging)	1

Conditions

None

Feature Cross Reference

- Paging, External
- Paging, Internal

Program 31 : Paging Setup

31-08 : BGM on External Paging

Level:
IN

Description

Use **Program 31-08 : BGM on External Paging** to set the Background Music option for each External Paging zone. If enabled, the system plays Background Music over the zone when it is idle.

When programming, the zones on the PGD(2)-U10 ADP are numbers 1~8. The CD-CP00-US zone is number 9.

Input Data

External Speaker Number	1~9
-------------------------	-----

Item No.	Item	Item	Input Data	Default
01	BGM	Enable/Disable the External Paging zone you select from broadcasting Background Music when it is idle.	0 = Disable (No) 1 = Enable (Yes)	0

Conditions

None

Feature Cross Reference

- Background Music
- Paging, External

Program 32 : Door Box and Sensor Setup

32-01 : Door Box Timers Setup

Level:
IN

Program

32

Description

Use **Program 32-01 : Door Box Timers Setup** to assign the timers used for the Door Box.

 *The Door Box feature is called Door Phone when programming via WebPro and using a multiline terminal.*

Input Data

Item No.	Item	Input Data	Default
01	Door Box Answer Time A multiline terminal user must answer Door Box chimes during this time.	0~64800 (sec)	30
02	Door Lock Cancel Time When a single line (2500 type) telephone user hook flashes or a multiline terminal user presses the Recall key while talking to a Door Box, the strike stays open for this time.	0~64800 (sec)	10
03	Off-Premise Call Forward by Door Box Disconnect Timer Define the conversation period for an Off-Premise Call Forward by Door Box call. When this timer expires, the caller hears busy tone for three seconds (fixed time), and the call is then disconnected.	0~64800 (sec)	60

Conditions

None

Feature Cross Reference

- Door Box

Program 32 : Door Box and Sensor Setup

32-02 : Door Box Ring Assignment

Level:
SA

Description

Use **Program 32-02 : Door Box Ring Assignment** to assign the extension which rings when a caller presses the associated Door Box call button.

 *The Door Box feature is called Door Phone when programming via WebPro and using a multiline terminal.*

Input Data

Door Box Number	1~8
-----------------	-----

Day/Night Mode	1~8
----------------	-----

Item No.	Door Box Ring Group Number	Extension Number	Default
01	01~32	Maximum eight digits	No Setting

Conditions

None

Feature Cross Reference

- Door Box

Program 32 : Door Box and Sensor Setup

32-03 : Door Box Basic Setup

Level:
IN

Description

Use **Program 32-03 : Door Box Basic Setup** to select the chime pattern and gain level for each Door Box. There are six distinctive chime patterns. The chime tones are defined in [80-01 : Service Tone Setup on page 2-591](#).

 *The Door Box feature is called Door Phone when programming via WebPro and using a multiline terminal.*

Input Data

Door Box Number	1~8
-----------------	-----

Item No.	Item	Input Data	Default
01	Chime Pattern	0 = None 1 = Door Box Ring 1 2 = Door Box Ring 2 3 = Door Box Ring 3 4 = Door Box Ring 4 5 = Door Box Ring 5 6 = Door Box Ring 6	Door Box 1 = 1 Door Box 2 = 2 Door Box 3 = 3 Door Box 4 = 4 Door Box 5 = 5 Door Box 6 = 6 Door Box 7 = 1 Door Box 8 = 1
02	CODEC Transmit Gain Setup (PGD(2)-U10 ADP to Door Box)	1~63 (-15.5dB ~ +15.5dB)	32
03	CODEC Receive Gain Setup (Door Box to PGD(2)-U10 ADP)	1~63 (-15.5dB ~ +15.5dB)	32

Conditions

None

Feature Cross Reference

- Door Box

Program 32 : Door Box and Sensor Setup

32-04 : Door Box Name Setup

Level:
IN

Description

Use **Program 32-04 : Door Box Name Setup** to define the name of each Door Box.

 *The Door Box feature is called Door Phone when programming via WebPro and using a multiline terminal.*

Input Data

Door Box Number	1~8
-----------------	-----

Item No.	Item	Input Data	Default
01	Door Box Name	Up to 12 characters	Door Box Name 1 = DOOR- 1 Door Box Name 2 = DOOR- 2 Door Box Name 3 = DOOR- 3 Door Box Name 4 = DOOR- 4 Door Box Name 5 = DOOR- 5 Door Box Name 6 = DOOR- 6 Door Box Name 7 = DOOR- 7 Door Box Name 8 = DOOR- 8

Conditions

None

Feature Cross Reference

- Door Box

Program 33 : CTA and ACI Setup

33-01 : ACI Port Type Setup

Level:
IN

Description

Use **Program 33-01 : ACI Port Type Setup** to set the function of each software port on an Analog Communications Interface. Each ACI software port can have only one function (input, output or none).

Input Data

ACI Port Number	01~96
-----------------	-------

Item No.	ACI Type	Default
01	0 = None 1 = MOH/BGM (Input) 2 = External Audio Port (Input/Output)	2

Conditions

None

Feature Cross Reference

- Analog Communications Interface (ACI)

Program

33

Program 33 : CTA and ACI Setup

33-02 : ACI Department Calling Group

Level:
IN

Description

Use **Program 33-02 : ACI Department Calling Group** to assign ACI ports to Department Groups. An ACI port can be in only one group.

Also use this program to set the ACI port priority. When a call comes into the ACI Department Group, it connects to the ACI port in order of its priority. A higher priority port (e.g., 1) receives calls before a lower priority port (e.g., 6). There are 96 ACI ports and 16 ACI Department Groups available.

Input Data

ACI Port Number	01~96
-----------------	-------

Item No.	Group Number	Priority
01	01~16	1~96

Default

ACI Port	Group	Priority
01	1	1
02	1	2
:	:	:
96	1	96

Conditions

None

Feature Cross Reference

- Analog Communications Interface (ACI)

Program 34 : Tie Line Setup

34-01 : E&M Tie Line Basic Setup

Level:
IN

Description

Use **Program 34-01 : E&M Tie Line Basic Setup** to define the basic settings for each E&M Tie line.

Input Data

Trunk Port Number	001~200
-------------------	---------

Item No.	Item	Input Data	Default	Description	Related Program
01	DID/E&M Start Signaling	0 = 2 nd Dial Tone 1 = Wink 2 = Immediate 3 = Delay	1	Set the start signaling mode for DID and Tie trunks. DID and Tie trunks can use either immediate start or wink start signaling.	22-02
02	Receive Dial Type for E&M Tie Line	0 = DP 1 = DTMF 2 = MF	1		10-09
03	E&M Dial-In Mode	0 = Specify Extension Number (Intercom) 1 = Use Conversion Table (NTT)	0	Determine if the incoming Tie Line call should be directed as an intercom call or if it should follow the DID Translation Table in Program 22-11.	22-11
04	E&M Line Dial Tone	0 = Disable (No) 1 = Enable (Yes)	1	Enter 1 if the Tie Line should send dial tone to the calling system after the call is set up. Enter 0 if the Tie Line should not send dial tone.	
05	System Toll Restriction	0 = System 1 = Each extension	0	Determine if an incoming Tie Line call should be subject to Toll Restriction.	21-05

Program

34

Conditions

None

Feature Cross Reference

- Tie Lines

Program 34 : Tie Line Setup

34-02 : E&M Tie Line Class of Service

Level:
IN

Description

Use **Program 34-02 : E&M Tie Line Class of Service** to assign a Class of Service to a Tie line (there are 15 Tie line Classes of Service). The Class of Service options are defined in Program 20-14. For each Tie line, make a separate entry for each Night Service mode.

Input Data

Trunk Port Number	1~200
-------------------	-------

Item No.	Day/Night Mode	Class	Default	Related Program
01	1~8	1~15	1	20-14

Conditions

- Program 20-06 cannot be used to assign Class of Service to Tie lines.

Feature Cross Reference

- Tie Lines

Program 34 : Tie Line Setup

34-03 : Trunk Group Routing for E&M Tie Lines

Level:
IN

Description

Use **Program 34-03 : Trunk Group Routing for E&M Tie Lines** to assign the trunk group route (1~8 or 1~100) chosen when a user seizes a Tie Line and dials 9. (Set Trunk Group Routing in Program 14-07.) If the system has Automatic Route Selection, dialing 9 accesses ARS. Make a separate entry for each Tie Line – for each Night Service Mode.

Input Data

Trunk Port Number	001~200
-------------------	---------

Item No.	Day/Night Mode	Route Table Number	Default
01	1~8	0~100 0 = No Setting	1

Conditions

None

Feature Cross Reference

- Tie Lines

Program 34 : Tie Line Setup

34-04 : E&M Tie Line Toll Restriction Class

Level:
IN

Description

Use **Program 34-04 : E&M Tie Line Toll Restriction Class** to enter a Toll Restriction Class for each Tie Line. There are 15 Toll Restriction Classes which are defined in Programs 21-05 and 21-06. For each Tie Line, you make a separate Toll Restriction Class entry for each Night Service mode.

Input Data

Trunk Port Number	001~200
-------------------	---------

Item No.	Day/Night Mode	Toll Restriction Class	Default	Related Program
01	1~8	1~15	2	21-05 14-01-08

Conditions

- Program 20-06 cannot be used to assign Toll Restriction to Tie Lines.

Feature Cross Reference

- Tie Lines

Program 34 : Tie Line Setup

34-05 : Tie Line Outgoing Call Restriction

Level:
IN

Description

Use **Program 34-05 : Tie Line Outgoing Call Restriction** to build a restriction matrix for outgoing trunk calls placed from an inbound trunk (e.g., dialed from a Tie Line). For each inbound trunk group, enable or disable access to each CO trunk group.

Input Data

Incoming Trunk Group Number	001~100
-----------------------------	---------

Outgoing Trunk Group Number	Input Data	Default
1~100	0 = Enable (Y-Tandem) 1 = Disable (N-Tandem)	0

Conditions

None

Feature Cross Reference

- Tie Lines

Program 34 : Tie Line Setup

34-06 : Add/Delete Digit for E&M Tie Line

Level:
IN

Description

Use **Program 34-06 : Add/Delete Digit for E&M Tie Line** to set digits that the system should add or delete for Tie Lines.

- Delete Digit**
Some Tie Line networks pass the location number and extension number to the remote side. This program allows the system to ignore such numbers for a call.

If individual extension users do not want to receive an incoming call, they could delete all digits including the extension number.
- Add Digit**
If a Tie Line network requires additional digits to reroute the call to a location, the digits for the location can be added to the received digits.

Input Data

Incoming Trunk Group Number	001~100
-----------------------------	---------

Item No.	Item	Input Data	Default
01	Delete Digit	0~255 (255 = delete all digits)	0
02	Additional Dial Digits	Up to four digits (0~9, *, #)	No Setting

Conditions

None

Feature Cross Reference

- Tie Lines

Program 34 : Tie Line Setup

34-07 : E&M Tie Line Timer

Level:
IN

Description

Use **Program 34-07 : E&M Tie Line Timer** to define the system service tone timers.

Input Data

Item No.	Item	Input Data	Default
01	First Digit Pause (E&M Immediate Start)	0~64800	3
02	First Digit Pause (E&M Wink Start)	0~64800	0
03	First Digit Pause (LD Trunk)	0~64800	3
04	LD Trunk Guard Time	0~64800	0
05	Trunk Answer Detect Timer for E&M	0~64800	30

Conditions

- If PRG 34-07-05 is left at default (30) the transferred call recalls to the station that performed the transfer when not answered.

Feature Cross Reference

- Tie Lines

Program 34 : Tie Line Setup

34-08 : Toll Restriction Data for E&M Tie Lines

Level:

IN

Description

Use **Program 34-08 : Toll Restriction Data for E&M Tie Lines** to define the toll restriction data for E&M Tie Lines. This data should be defined if Tie Line Toll Restriction is enabled in Program 21-05-13.

Input Data

Class of Service	01~15
------------------	-------

Item No.	Table No.	Dial Data	Default	Related Program
01	01~20	Up to 10 Digits (0~9, *, #)	No Setting	21-05-13

Conditions

None

Feature Cross Reference

- Tie Lines

Program 34 : Tie Line Setup

34-09 : ANI/DNIS Service Options

Level:
IN

Description

Use **Program 34-09 : ANI/DNIS Service Options** to define the ANI//DNIS service option setup for E&M Class of Service.

Input Data

Class of Service	01~15
------------------	-------

Item No.	Name	Input Data	Default	Related Program
			COS 2~15	
01	Receive Format Specify the format of the ANI/DNIS data received from the telco. Make sure your entry is compatible with the service the telco provides. The character * indicates a delimiter. <i>If PRG34-01-02 is selected to 2 (MF), this PRG works only as 4 = *ANI*DNIS*.</i>	0 = Address 1 = *ANI* 2 = *DNIS* 3 = *ANI*Address* 4 = *ANI*DNIS* 5 = *DNIS*ANI* (* = Delimiter Code)	0	34-01-02 34-09-02
02	Delimiter Dial Code Define the character Telco uses as a delimiter (see entries 1~5 in Item 1 above). Valid entries are 0~9, #, and *.	1~9, 0, #, *	*	34-09-01
03	Route Setup of Receive Dial Specify the source of the data the system uses to route incoming ANI/DNIS calls. If option 2 is selected, refer to Program 34-09-04.	0 = Fixed Route (Item 08) (No Routing) 1 = Routes on Received DNIS or Address Data 2 = Routes on Received ANI Data	0	22-09-01 22-11-01 34-09-04 34-09-08

Item No.	Name	Input Data	Default	Related Program
			COS 2~15	
04	<p>Route Table Setup of Target Dial</p> <p>Set how the system uses the route data (gathered in Item 3) to route incoming ANI/DNIS calls.</p> <p>If option 2 is selected, and the call is to be routed using the DID table (1), up to 8 digits can be matched. The number of expected digits set in Program 22-09-01 must match the ANI digits defined in Program 22-11-01. For example, if an ANI/DNIS number received was *2035551234*3001* and Program 22-09-01=4, the entry in 22-11-01 must be 1234 with the defined target extension.</p> <p>If the call is to be routed using the SPD table (0), up to 24 digits can be matched. Define the range of the SPD table to be used in Program 34-09-06. The data is compared to the entries in Program 13-04-01 and then routed according to Program 13-04-03.</p>	<p>0 = SPD Table (Program 13-03)</p> <p>1 = DID Table (Program 22-11)</p>	0	<p>13-04-01</p> <p>13-04-03</p> <p>22-09-01</p> <p>22-11</p> <p>34-09-05</p> <p>34-09-06</p>
05	<p>ANI/DNIS Display as Target Dial Name</p> <p>Set whether or not ANI data should appear on telephone displays as part of Caller ID display.</p>	<p>0 = Display Off</p> <p>1 = Display On</p>	0	<p>13-04</p> <p>20-09-02</p> <p>22-11-03</p> <p>23-09-04</p>
06	<p>Routing SPD Table Setup</p> <p>Define which part of the SPD Table set up in Program 13-04 the system uses for ANI/DNIS Caller ID look-ups and ANI/DNIS routing.</p> <p>This is required if Items 04 and 05 above are 1 (Caller ID on). When you specify a starting and end address, the system uses the part of the table for look-ups.</p> <p>When you specify a starting address and length, the system uses that part of the table for routing. If the incoming ANI/DNIS number data matches the Number entry in the table, the system routes according to the associated Name data. That data can be an extension, Department Group pilot number, the voice mail master number or a trunk ring group.</p>	<p>Start = 0, 100~1900</p> <p>End = 0, 99~1999</p>	<p>Start = 0</p> <p>End = 0</p>	13-04
07	<p>Routing on ANI/DNIS Error</p> <p>Determine how the system handles an ANI/DNIS call if a data error is detected in the incoming data string.</p>	<p>0 = Play Busy Tone to Caller</p> <p>1 = Route Caller to Ring Group Specified in Program 25-03 (Transfer)</p>	0	25-03

Item No.	Name	Input Data	Default	Related Program
			COS 2~15	
08	Routing When Destination Busy or No Answer Determine how the system handles an ANI/DNIS call if destination is busy or does not answer.	0 = Play Busy or Ringback Tone to Caller (Busy/NoAns) 1 = Route Caller to Ring Group Specified in Program 25-04 (Transfer)	0	25-04
09	Calling Number Address Length When Item 01 = 0 (ANI/DNIS receive format is the address). Specify the address length.	1~8 digits	7	34-09-01

Conditions

None

Feature Cross Reference

- T1 Trunking (with ANI/DNIS Compatibility)
- Tie Lines

Program 34 : Tie Line Setup

34-10 : Digits Delete for T1 ANI Assignment

Level:

IN

Description

Use **Program 34-10 : Digits Delete for T1 ANI Assignment** to delete the Information Digits received from the Network on Feature Group D Trunks.

Input Data

Incoming Trunk Group No.	001~100
--------------------------	---------

Item No.	Item	Input Data	Default	Description
01	Delete Digits for T1 ANI Define the number of digits to delete from the information element received from Telco.	0~9 digits	2	Assign the number of information digits to delete from the element received from the Network.

Conditions

None

Feature Cross Reference

- T1 Trunking (with ANI/DNIS Ability)

Example:

Example of ANI information KP009727517645STKP7100ST.

00	Information digits
9727517645	ANI information
7100	DNIS Digits

THIS PAGE INTENTIONALLY LEFT BLANK

Program 35 : SMDR Account Code Setup

35-01 : SMDR Options

Level:
IN

Program

35

Description

Use **Program 35-01 : SMDR Options** to set the SMDR (Station Message Detail Recording) options for each of the eight SMDR ports. Refer to the following chart for a description of each option, its range and default setting.

Input Data

SMDR Port Number	1~8
------------------	-----

Item No.	Item	Input Data	Default
01	Output Port Type Specify the type of connection used for SMDR. The baud rate for the COM port should be set in Program 10-21-02 or 15-02-19.	0 = None 3 = LAN 4 = CTA/CTU	0
02	Output Destination Number Specify the SMDR printer output extension (CTA/CTU extension number).	Up to 8 digits	No Setting
03	Header Language Specify the language in which the SMDR header should be printed.	0 = English 1 = German 2 = French 3 = Italian 4 = Spanish	0
04	Omit Digits The number of digits entered in this option do not print on the SMDR report. For example, if the entry is 10, the first 10 digits a user dials do not appear on the SMDR report.	0~24 (0 = Not applied)	0
05	Minimum Digits Outgoing calls must be at least this number of digits for inclusion in the SMDR report.	0~24 (0 = Not applied)	0

Item No.	Item	Input Data	Default
06	Minimum Call Duration The duration of the call must be at least this time to be included on the SMDR report.	0~65535 (sec) (0 = All)	0
07	Minimum Ring Time (For Incoming Calls) A call must ring for at least this time to be included on the SMDR report.	0~65535 (sec) (0 = All)	0
08	Format Selection	0 = NA Type (North America) 1 = G/J Type (Overseas/ Japan)	0

Conditions

None

Feature Cross Reference

- Station Message Detail Recording

Program 35 : SMDR Account Code Setup

35-02 : SMDR Output Options

Level:
IN

Description

Use **Program 35-02 : SMDR Output Options** to set the SMDR (Station Message Detail Recording) output options for each of the eight SMDR ports. Refer to the following chart for a description of each option, its range and default setting.

Input Data

SMDR Port Number	1~8
------------------	-----

Item No.	Item	Input Data	Default
01	Toll Restricted Call SMDR can include or exclude calls blocked by Toll Restriction.	0 = Not Displayed 1 = Displayed	1
02	PBX Calls When the system is behind a PBX, SMDR can include all calls (1), or just calls dialed using the PBX trunk access code (0).	0 = Not Displayed 1 = Displayed	1
03	Trunk Number or Name Select whether the system should display the trunk number or the name on SMDR reports. <i>If this option is set to 1, Program 35-02-14 must be set to 0.</i>	0 = Name 1 = Number	1
04	Summary (Daily) Set to 1 to have the SMDR report provide a daily summary (at midnight every night).	0 = Not Displayed 1 = Displayed	1
05	Summary (Weekly) Set to 1 to have the SMDR report provide a weekly summary (every Saturday at midnight).	0 = Not Displayed 1 = Displayed	1
06	Summary (Monthly) Set to 1 to have the SMDR report provide a monthly summary (at midnight on the last day of the month).	0 = Not Displayed 1 = Displayed	1
07	Toll Charge Cost Set to 1 to have the SMDR report include toll charges.	0 = Not Displayed 1 = Displayed	1

Item No.	Item	Input Data	Default
08	Incoming Call Enable this option (1) to have the SMDR report include incoming calls. If you disable this option (0), incoming calls do not print.	0 = Not Displayed 1 = Displayed	1
09	Extension Number or Name Set to 1 to have the SMDR report include extension numbers. Set to 0 to have the SMDR report include extension names.	0 = Name 1 = Number	1
10	All Lines Busy (ALB) Output Determine if the All Lines Busy (ALB) indication should be displayed.	0 = Not Displayed 1 = Displayed	0
11	Walking Toll Restriction Table Number	0 = Not Output 1 = Output	1
12	DID Table Name Output Determine if the DID table name should be displayed.	0 = Not Displayed 1 = Displayed	0
13	CLI Output When DID to Trunk Determine if the CLI output should be displayed for DID.	0 = Not Displayed 1 = Displayed	0
14	Date Determine whether or not the date should be displayed on SMDR reports. <i>This option must be set to 0 if the trunk name is set to be displayed in Program 35-02-03.</i>	0 = Not Displayed 1 = Displayed	0
15	CLI/DID Number Switching Determine if the CLI or DID Number Switching should be displayed.	0 = CLI (CLIP) 1 = DID Calling Number 2 = CID Name	0
16	Trunk Name or Received Dialed Number Determine how the SMDR should print incoming calls on ANI/DNIS or DID trunks. If set to 1, ANI/DNIS trunks can print DNIS digits. If set to 0 trunk names are printed instead.	0 = Trunk Port Name 1 = Received Dialed Number	0
17	Print Account Code or Caller Name of Incoming Call Determine if SMDR should print Account Code or Caller Name of Incoming Call.	0 = ACC 1 = CNAME	0
18	Print Mode for Caller Name of Incoming Call Determine how SMDR should print Caller Name of Incoming Call.	0 = Normal 1 = Line Feed	0
21	--- Not Used ---		

Conditions

None

Feature Cross Reference

- Station Message Detail Recording

Program 35 : SMDR Account Code Setup

35-03 : SMDR Port Assignment for Trunk Group

Level:
IN

Description

Use **Program 35-03 : SMDR Port Assignment for Trunk Group** to assign the SMDR port for each trunk group. For each Trunk Group, select the SMDR port where the incoming SMDR information should be sent.

Input Data

Trunk Group Number	1~100
--------------------	-------

Item No.	SMDR Port No.	Default
01	1~8	1

Conditions

None

Feature Cross Reference

- Station Message Detail Recording
- Trunk Group Routing

Program 35 : SMDR Account Code Setup

35-04 : SMDR Port Assignment for Department Groups

Level:

IN

Description

Use **Program 35-04 : SMDR Port Assignment for Department Groups** to assign the SMDR port for each Department Group. For each Department Group, select the SMDR port where the outgoing SMDR information should be sent.

 *There are 64 available Department Groups.*

Input Data

Department Group Number	01~64
-------------------------	-------

Item No.	SMDR Port No.	Default
01	1~8	1

Conditions

None

Feature Cross Reference

- Station Message Detail Recording

Program 35 : SMDR Account Code Setup

35-05 : Account Code Setup

Level:
IN

Description

Use **Program 35-05 : Account Code Setup** to set various Account Code options for an extension Class of Service. Assign a Class of Service to extensions in Program 20-06.

Input Data

Class of Service Number	01~15
-------------------------	-------

Item No.	Item	Input Data	Default
01	Account Code Mode Select the Account Code Mode (0~3).	0 = Account Codes Disabled (None) 1 = Account Codes optional 2 = Account Codes Required but not verified (No verify) 3 = Account Codes Required and Verified (Verify)	0
02	Forced Account Code Toll Call Setup Enable Account Codes for all calls or just toll calls (for mode 2 or 3 in Item 01 above).	0 = Account Codes for toll and local calls All) 1 = Account Codes just for toll calls (STD)	0
03	Account Codes for Incoming Calls Allow users to enter Account Codes for incoming calls. If disabled, any code entered dials out on the connected trunk.	0 = Account Codes for incoming calls disabled (No) 1 = Account Codes for incoming calls enabled (Yes)	0
04	Hiding Account Codes Hide or show the Account codes on a telephone display.	0 = Account Codes displayed 1 = Account Codes not displayed	0

Conditions

None

Feature Cross Reference

- Account Codes

Program 35 : SMDR Account Code Setup

35-06 : Verified Account Code Table

Level:

IN

Description

Use **Program 35-06 : Verified Account Code Table** to enter Account Codes into the Verified Account Code list. You can enter up to 2000 codes with 3~6 digits, using the characters 0~9 or #. Use the LK1 to enter a wild card. For example, the entry @234 means the user can enter 0234-9234.

Input Data

Verified Account Code Bin Number	1~2000
----------------------------------	--------

Item No.	Verified Account Code	Default
01	1~9, 0, #, @ (@ = Wild card) (Up to 16 digits)	No Setting

Conditions

None

Feature Cross Reference

- Account Codes - Forced/Verified/Unverified

Program 40 : Voice Recording System

40-01 : Voice Mail Basic Setup

Level:
IN

Description

Use Program 40-01 : Voice Mail Basic Setup to define the basic operation of Voice Mail.

Input Data

Item No.	Item	Input Data	Default	Description
01	--- Not Used ---			
02	--- Not Used ---			
03	--- Not Used ---			
04	--- Not Used ---			
05	--- Not Used ---			
06	--- Not Used ---			
07	--- Not Used ---			
10	--- Not Used ---			

Conditions

None

Feature Cross Reference

- Voice Mail Integration (Analog)

Program

40

Program 40 : Voice Recording System

40-02 : Mailbox Setup

Level:
SA

Description

Use **Program 40-02 : Mailbox Setup** to define the mailbox of the Voice Mail.

There are a maximum of 500 mailboxes. Use this program to set the box number and password linked to the extension number (or pilot number) for each mailbox.

Input Data

Message Box Number	01~500
--------------------	--------

Item No.	Item	Input Data	Default	Description
01	--- Not Used ---			
02	--- Not Used ---			

Conditions

None

Feature Cross Reference

- Voice Mail Integration (Analog)

Program 40 : Voice Recording System

40-03 : Message Recording Setup

Level:
IN

Description

Use **Program 40-03 : Message Recording Setup** to define the auto-answering operation of the Voice Mail.

Input Data

Item No.	Item	Input Data	Default
01	--- Not Used ---		
02	--- Not Used ---		
03	--- Not Used ---		

Conditions

None

Feature Cross Reference

- Voice Mail Integration (Analog)

Program 40 : Voice Recording System

40-04 : Live Recording Setup

Level:
IN

Description

Use **Program 40-04 : Live Recording Setup** to define the conversation recording operation of the Voice Mail.

Input Data

Item No.	Item	Input Data	Default	Description
01	--- Not Used ---			
02	--- Not Used ---			
03	--- Not Used ---			
04	--- Not Used ---			

Conditions

None

Feature Cross Reference

- Voice Mail Integration (Analog)

Program 40 : Voice Recording System

40-05 : Call Information Setup

Level:
IN

Description

Use **Program 40-05 : Call Information Setup** to define the incoming notice of the Voice Mail.

Input Data

Item No.	Item	Input Data	Default
01	--- Not Used ---		
02	--- Not Used ---		
03	--- Not Used ---		
04	--- Not Used ---		
05	--- Not Used ---		
06	--- Not Used ---		
07	--- Not Used ---		

Conditions

None

Feature Cross Reference

- Voice Mail Integration (Analog)

Program 40 : Voice Recording System

40-06 : Voice Mail Automated Attendant Data Setup

Level:
IN

Description

Use **Program 40-06 : Voice Mail Automated Attendant Data Setup** to define the outside lines to use the Automated Attendant recording operation of the Voice Mail.

Input Data

Trunk Port Number	1~200
Day/Night Mode	1~8

Item No.	Item	Input Data	Default
01	--- Not Used ---		
02	--- Not Used ---		
03	--- Not Used ---		

Conditions

None

Feature Cross Reference

- Voice Mail Integration (Analog)

Program 40 : Voice Recording System

40-07 : Voice Prompt Language Assignment for VRS

Level:

IN

Description

Use **Program 40-07 : Voice Prompt Language Assignment for VRS** to specify the language to be used for the VRS prompts.

Input Data

Item No.	Item	Input Data	Default
01	Voice Prompt Language Assignment for VRS	01 = US English 02 = UK English 03 = Australian English 04 = French Canadian 05 = Dutch 06 = Mexican Spanish 07 = Latin American Spanish 08 = Italian 09 = German 10 = Madrid Spanish 11 = Norwegian 12 = Parisian French 13 = Brazilian Portuguese 14 = Japanese 15 = Mandarin Chinese 16 = Korean 17 = Iberian Portuguese 18 = Greek 19 = Danish 20 = Swedish 21 = Thai 22 = Mandarin Chinese (Taiwan) 23 = Flemish	1

Conditions

None

Feature Cross Reference

- Voice Mail Integration (Analog)

Program 40 : Voice Recording System

40-08 : Voice Prompt Language Assignment for Mailboxes

Level:

IN

Description

Use **Program 40-08 : Voice Prompt Language Assignment for Mailboxes** to select the language to be used for the mailboxes.

Input Data

Mailbox Number	001~500
----------------	---------

Item No.	Item	Input Data	Default
01	--- Not Used ---		

Conditions

None

Feature Cross Reference

- Voice Mail Integration (Analog)

Program 40 : Voice Recording System

40-09 : Voice Mail Multiple Address Group Setup

Level:
IN

Description

Use **Program 40-09 : Voice Mail Multiple Address Group Setup** to define the broadcast group of a Voice Mail mailbox.

Input Data

Multiple Address Group Number	1~10
-------------------------------	------

Item No.	Destination Box Number	Box Number	Default
01	--- Not Used ---		

Conditions

None

Feature Cross Reference

- Voice Mail Integration (Analog)

Program 40 : Voice Recording System

40-10 : Voice Announcement Service Option

Level:
IN

Description

In **Program 40-10 : Voice Announcement Service Option** define the system options for the Voice Announcement feature.

Input Data

Item No.	Item	Input Data	Default
01	VRS Fixed Message Enable (1)/Disable (0) the system ability to play the fixed VRS messages (such as You have a message).	0 = Not Used 1 = Use	0
02	General Message Number Assign the VRS message number to use for the General Message.	0~100 0 = No General Message Service	0
03	VRS No Answer Destination Assign the transferred Ring Group when the VRS is unanswered after Call Forwarding with Personal Greeting Message.	0~100 (Incoming Ring Group Number)	0 (No Setting)
04	VRS No Answer Time If an extension has Personal Greeting enabled and all VRS ports are busy, a DIL or DISA call to the extension waits this time for a VRS port to become free.	0~64800 (sec)	0
05	Park and Page Repeat Timer (VRS Msg Resend) If a Park and Page is not picked up during this time, the Paging announcement repeats.	0~64800 (sec)	0
06	Set VRS Message for Private Call Refuse (VRS Msg Private Call) This item assigns the VRS Message number to be used as Private Call Refuse. When Fixed message is set, VRS message guidance is: "Your call cannot go through."	0~101 0 = No message 101 = Fixed message	0

Input Data

Item No.	Item	Input Data	Default
07	Set VRS Message for Caller ID Refuse (VRS Msg CID) Assign the VRS Message number to be used as Caller ID Refuse. When Fixed Message is set, VRS message guidance is: "Your call cannot go through."	0~101(0 = No message 101 = Fixed message	0
08	Call Attendant Busy Message	0~100 0 = No message	0
09	Call Attendant No Answer Message	0~100 0 = No message	0

Conditions

None

Feature Cross Reference

- Voice Response System (VRS)

Program 40 : Voice Recording System

40-11 : Preamble Message Assignment

Level:

IN

Description

In **Program 40-11 : Preamble Message Assignment** to assign the VRS message number to be used as the Preamble Message for each trunk. When the extension user answers the incoming call, the assigned VRS message is sent to the outside caller.

Input Data

Trunk Port Number	1~200
-------------------	-------

Item No.	Day/Night Mode	VRS Message Number	Default
01	1~8	0~100 0 = No Service	0

Conditions

None

Feature Cross Reference

- Voice Response System (VRS)

THIS PAGE INTENTIONALLY LEFT BLANK

Program 41 : ACD Setup

41-01 : System Options for ACD

Level:
IN

Program

41

Description

In Program 41-01 : System Options for ACD define the system options for the ACD feature.

Input Data

Item No.	Item	Input Data	Default
01	System Supervisory Extension	Up to eight digits (0~9, *, #)	No Setting
02	Login ID Code Digit	0~20 0 = No Login ID	0
03	ACD MIS Connection Ports	0 = None 3 = LAN (CD-CP00-US)	0
04	ACD-MIS Command Notification when a BT Message is returned	0 = Notifies 1 = No notification	0

Conditions

None

Feature Cross Reference

- Automatic Call Distribution (ACD)

Program 41 : ACD Setup

41-02 : ACD Group and Agent Assignments

Level:
SA

Description

In **Program 41-02 : ACD Group and Agent Assignments**, for each ACD extension number, assign an ACD Group (1~64). An ACD Group number is assigned to each Work Period number (1~8).

The assigned extension works as an ACD agent extension in the following cases:

- The trunk belonging to an ACD group receives an incoming call while an ACD agent is logged in.
- An extension transfers a call to an ACD group using the ACD group pilot number.
- An incoming call is received with a DID/DISA number which is assigned as an ACD pilot number.

Input Data

Extension Number	Up to eight digits
------------------	--------------------

Item No.	ACD Work Period Mode Number	ACD Group No.	Default
01	1~8	0~64 0 = No setting	0

Conditions

None

Feature Cross Reference

- Automatic Call Distribution (ACD)

Program 41 : ACD Setup

41-03 : Incoming Ring Group Assignment for ACD Group

Level:

SA

Description

In **Program 41-03 : Incoming Ring Group Assignment for ACD Group**, for each incoming trunk group set up in Program 22-05, designate which ACD Group (1~64) the trunks should ring for each of the eight Work Periods. Also use this program to assign an Incoming Trunk Ring Group as priority or normal. Use Program 41-06 to set up the Work Schedules and Work Periods for trunks. Use Program 41-07 to assign the Work Schedules to the days of the week.

Input Data

Incoming Ring Group Number	1~100
----------------------------	-------

ACD Work Period Mode Number	1~8
-----------------------------	-----

Item No.	Item	Input Data	Default
01	ACD Group Number	0~64 0 = No setting	0
02	Night Announcement Service	0 = No 1 = Yes	0
03	Priority Data Determine whether or not an incoming call to a trunk ring group should follow a priority assignment.	0, 1~7 0 = No Priority 1 = Highest Priority 7 = Lowest Priority	0

Conditions

None

Feature Cross Reference

- Automatic Call Distribution (ACD)
- Ring Groups

Program 41 : ACD Setup

41-04 : ACD Group Supervisor

Level:
SA

Description

For each ACD Group (1~64), use **Program 41-04 : ACD Group Supervisor** to assign the group supervisor extension and operating mode. Operating modes are:

- 0 = Supervisor extension does not receive ACD Group calls.
- 1 = Supervisor extension receives ACD Group overflow calls only.
- 2 = Supervisor extension receives ACD Group calls just like all other agents.

An ACD Group can have only one supervisor. In addition, an extension can be a supervisor for only one ACD Group.

Input Data

ACD Group No.	01~64
---------------	-------

Item No.	Item	Input Data	Default
01	Group Supervisor Extension	Extension Number (Up to eight digits)	No Setting
02	Operation Type	0 = Do not receive ACD incoming calls (No) 1 = Receive ACD incoming calls for overflow (Busy) 2 = Receive ACD incoming calls all the time (Yes)	0

Conditions

- If you assign an extension as a ACD Group Supervisor in this program, you cannot program the same extension as a System Supervisor in Program 41-01-01.

Feature Cross Reference

- Automatic Call Distribution (ACD)

Program 41 : ACD Setup

41-05 : ACD Agent Work Schedules

Level:
SA

Description

Use **Program 41-05 : ACD Agent Work Schedules** to set up the Work Schedules for ACD Agents and Groups. For each ACD Work Schedule (1~4), designate the start and stop times for each of the eight Work Periods. After you set up the schedules in this program, assign them to days of the week in Program 41-07. (This is the same program used by the Trunk Work Schedules.)

ACD extensions can log in only during their work period. ACD extensions receive the following calls when they are logged in.

- ACD Call on a Trunk
When the incoming ring group is assigned in the operating time (Program 41-03 and 41-06).
- ACD Pilot Number Call
Any time – if ACD extensions are available.

Input Data

ACD Work Schedule Time Pattern	1~4
--------------------------------	-----

Item No.	Work Period Mode Number	Start Time	End Time	Default
01	1~8	0000~2359	0000~2359	(Start) 0000 (End) 0000

Conditions

None

Feature Cross Reference

- Automatic Call Distribution (ACD)

Program 41 : ACD Setup

41-06 : Trunk Work Schedules

Level:
SA

Description

Use **Program 41-06 : Trunk Work Schedules** to set up the Work Schedules for trunks. For each Work Schedule (1~4), designate the start and stop times for each of the eight Work Periods. After you set up the schedules, assign them to days of the week in Program 41-07. (This is the same program used by the ACD Agent Work Schedules.)

Input Data

ACD Work Schedule Time Pattern Number	1~4
---------------------------------------	-----

Item No.	Work Period Mode Number	Start Time	End Time	Default
01	1~8	0000~2359	0000~2359	(Start) 0000 (End) 0000

Conditions

None

Feature Cross Reference

- Automatic Call Distribution (ACD)

Program 41 : ACD Setup

41-07 : ACD Weekly Schedule Setup

Level:
SA

Description

Use **Program 41-07 : ACD Weekly Schedule Setup** to assign the four Work Schedules (1~4) to days of the week. The assignments you make in this program apply to both the ACD Agent Work Schedules (Program 41-05) and the Trunk Work Schedules (Program 41-06).

Input Data

Item No.	Day Number	Time Pattern	Default
01	1 = Sunday	0~4 0 = No ACD	0
	2 = Monday	0~4 0 = No ACD	0
	3 = Tuesday	0~4 0 = No ACD	0
	4 = Wednesday	0~4 0 = No ACD	0
	5 = Thursday	0~4 0 = No ACD	0
	6 = Friday	0~4 0 = No ACD	0
	7 = Saturday	0~4 0 = No ACD	0

Conditions

None

Feature Cross Reference

- Automatic Call Distribution (ACD)

Program 41 : ACD Setup

41-08 : ACD Overflow Options

Level:
SA

Description

For each ACD Group (1~64), use **Program 41-08 : ACD Overflow Options** to assign the overflow mode (0~9), destination and announcement message types. Delay Announcement functions are not available for ACD pilot number calls. Each ACD Group can have unique overflow options. The table below outlines the entry options.

Input Data

ACD Group No.	01~64
---------------	-------

Item No.	Item	Input Data	Default
01	Overflow Operation Mode	0 = No Overflow (None) 1 = Overflow with No Announcement 2 = No Overflow with First Announcement Only 3 = No Overflow with First & Second Announcements 4 = Overflow with First Announcement Only 5 = Overflow with First & Second Announcement 6 = --- Not Used --- 7 = --- Not Used --- 8 = No Overflow with Second Announcement Only 9 = Overflow with Second Announcement Only	0
02	ACD Overflow Destination	0 = No Setting 1~64 = ACD Group 65 = Overflow Table (Program 41-09) 66 = Voice Mail Integration 67 = System Speed (Program 41-08-05) 68 = Incoming Ring Group (Program 41-08-06)	0
03	Delay Announcement Source Type	0 = ACI 1 = VRS 2 = VM8000 InMail	0
04	ACD Overflow Transfer Time	0~64800 (sec)	30
05	System Speed Dial Bin	0~1999 (Used when 41-08-02 is set to 67)	1999
06	Incoming Ring Group when Overflow	1~100 (Used when 41-08-02 is set to 68)	1

Conditions

None

Feature Cross Reference

- Automatic Call Distribution (ACD)

Program 41 : ACD Setup

41-09 : ACD Overflow Table Setting

Level:

SA

Description

Use **Program 41-09 : ACD Overflow Table Setting** to define the ACD group to which a call is transferred when overflow occurs.

Input Data

ACD Group No.	01~64
---------------	-------

Item No.	Priority Order Number	Transfer ACD Group Number With Overflow	Default
01	1~7	0~65 0 = No Setting 65 = In-Skin Voice Mail Integration	0

Conditions

None

Feature Cross Reference

- Automatic Call Distribution (ACD)

Program 41 : ACD Setup

41-10 : ACI Delay Announcement

Level:
SA

Description

Use Program **41-10 : ACI Delay Announcement** to define the ACI port number to be used for the delay announcement.

This program is activated when the delay announcement source and options are assigned as ACI in Program 41-08-03.

Input Data

ACD Group No	01~64
--------------	-------

Item No.	Item	Input Data	Default
01	1st Delay Announcement ACI Port Number	0~96 0 = No Setting	0
02	2nd Delay Announcement ACI Port Number	0~96 0 = No Setting	0
03	1st Delay Announcement Connection Timer Set the time before the 1st Delay Announcement is played.	0~64800 (sec)	4
04	2nd Delay Announcement Connection Timer Set the time the 1st Delay Announcement plays before the 2nd Delay Announcement starts to play.	0~64800 (sec)	60
05	2nd Delay Announcement Sending Duration Set the time the 2nd Delay Announcement plays. After this time expires, the call disconnects. To keep the call in queue, set this time to 0.	0~64800 (sec)	0

Conditions

None

Feature Cross Reference

- Automatic Call Distribution (ACD)

Program 41 : ACD Setup

41-11 : VRS Delay Announcement

Level:
SA

Description

Use **Program 41-11 : VRS Delay Announcement** to assign the VRS message number to use as the message source for the 1st and 2nd Delay Announcement Messages. Refer to Program 41-08 for more on setting up the ACD overflow options.

This program is activated when the delay announcement source and options are assigned as VRS in Program 41-08-03.

Input Data

ACD Group No.	01~64
---------------	-------

Item No.	Item	Input Data	Default
01	Delay Message Start Timer Input the time before the 1st Delay Message Starts.	0~64800 (sec)	0
02	1st Delay Message Number Input the VRS Message to be played as the 1st Delay Message.	0~101 0 = No Message 101 = Fixed Message	0
03	1st Delay Message Sending Count Input the number of times the 1st Delay Message is sent. If set to 0, the message is not played.	0~255	0
04	2nd Delay Message Number Input the VRS Message to be played as the 2nd Delay Message.	0~101 0 = No Message 101 = Fixed Message	0
05	2nd Waiting Message Sending Count Input the number of times the 2nd Delay Message is sent. If set to 0, the message is not played.	0~255	0
06	Tone Kind at Message Interval Input what is heard between the Delay messages.	0 = Ring Back Tone 1 = MOH Tone 2 = BGM Source	0
07	ACD Forced Disconnect Time after the 2nd Delay Message Set the time, after the last 2nd Delay Message is played, before the call is disconnected.	0~64800 (sec) (0 = No Disconnect)	60

Item No.	Item	Input Data	Default
08	Queue Depth Announcement Input when the Queue Depth Announcement is played.	0 = Disable 1 = After 1st (1st) 2 = After 2nd (2nd) 3 = After 1st and 2nd (1st and 2nd)	0

Conditions

None

Feature Cross Reference

- Automatic Call Distribution (ACD)

Program 41 : ACD Setup

41-12 : Night Announcement Setup

Level:
SA

Description

Use **Program 41-12 : Night Announcement Setup** to define the night announce voice resource and sending time for each ACD group. Night announcement availability depends on the setting in Program 41-03-02. The night announcement function is not available for ACD pilot number calls.

Input Data

ACD Group Number	01~64
------------------	-------

Item No.	Item	Input Data	Default
01	Night Announcement Source Type	0 = ACI 1 = VRS	0
02	Night Announcement ACI Port Number Only used when PRG 41-12-01 is set to 0.	0~96 0 = No Setting	0
03	ACD Night Announce Sending Time Only used when PRG 41-12-01 is set to 0.	0~64800 (sec)	30

Conditions

- The Night Announcement function is not available for ACD pilot number call.

Feature Cross Reference

- Automatic Call Distribution (ACD)

Program 41 : ACD Setup

41-13 : VRS Message Number for Night Announcement

Level:

SA

Description

Use **Program 41-13 : VRS Message Number for Night Announcement** to define the VRS message number to use as the night announcement. This program is activated when the night announcement source is assigned as VRS in Program 41-12-01.

Input Data

ACD Group No.	01~64
---------------	-------

Item No.	Item	Input Data	Default
01	VRS Message Number Input the VRS Message to use for the Night Announcement.	0~100 0 = No Message	0
02	Tone Kind at Message Interval Input what is heard between the Night Announcements.	0 = Ring Back Tone 1 = MOH Tone 2 = BGM Source	0

Conditions

None

Feature Cross Reference

- Automatic Call Distribution (ACD)

Program 41 : ACD Setup

41-14 : ACD Options Setup

Level:
SA

Description

Use **Program 41-14 : ACD Options Setup** to set various options for ACD Groups. When you set an option for an ACD Group, the setting is in force (if applicable) for all agents in the group. The chart below shows each of the ACD options, the entries available, and the default entry.

Input Data

ACD Group No	01~64
--------------	-------

Item No.	Item	Input Data	Default
01	Emergency Call Operation Mode The supervisor must be logged in and have an Emergency Key programmed for this feature. By pressing the key once, the supervisor monitors the call – pressing twice barges in on the call.	0 = Call to system supervisory extension when group supervisory extension is busy. 1 = No calls to system supervisory extension when group supervisory extension is busy.	0
02	Automatic Wrap Up Mode Enable/Disable Automatic Wrap Up mode.	0 = After wrap up the mode key is pressed. (Manual) 1 = After call is finished automatically. (Auto)	0
03	ACD Priority for Overflow Calls Determine whether the ACD group should use its own priority assignment or follow the priority assigned in Program 41-03-03.	0 = Own group priority 1 = Priority order by Program 41-03-03	0
04	Automatic Answer at Headset Enable/Disable Automatic Answer for agents using headsets.	0 = Off 1 = On	0
06	Call Queuing after 2nd Announcement Determine whether the caller should hear the 2nd Delay Announcement and then be taken out of queue (1), or placed back into queue (0).	0 = Enable (Yes) 1 = Disable (No)	0

Item No.	Item	Input Data	Default
07	Automatic Off Duty for SLT Enable/Disable Automatic Off Duty (rest) mode for agents with SLT.	0 = No change to Off Duty mode 1 = Change to Off Duty mode automatically (Skip)	0
08	ACD Off Duty Mode Enable/Disable the ability to receive internal calls when in Off Duty Mode.	0 = Cannot receive internal call 1 = Can receive internal call	0
09	Automatic Wrap Up End Time Input the time the agent is in Wrap mode when Wrap key is pressed, or automatically put into Wrap mode.	0~64800 (sec)	0
10	ACD No Answer Skip Time Set the time a call to the ACD Group rings an idle extension before routing to the next agent.	0~64800 (sec)	10
12	Start Headset Ear Piece Ringing (for SLT)	0~64800 (sec)	0
13	1st Data – ACD Queue 1-Digit Assignment 2nd Data – Destination Number Type 3rd Data – Destination Number	1st Data – Up to one Digit (0, 1~9, #, *) 2nd Data – 0 = None 1 = Extension or Voice Mail 2 = Incoming Ring Group 3 = Speed Dial Areas 4 = ACD Group 3rd Data – Up to eight digits (0, 1~9, #, *)	Blank 0 Blank
14	DTMF Detection Assignment during Delay Announcement Set whether the DTMF Detection for Dial Out occurs during or after the message is played.	0 = Does not detect during message 1 = Detect during message	1
15	DTMF Detect Time after Delay Announcement Message Set the time for DTMF Detection after the Delay Announcement Message.	0~64800 (sec)	0

Conditions

None

Feature Cross Reference

- Automatic Call Distribution (ACD)

Program 41 : ACD Setup

41-15 : ACD Queue Alarm Information

Level:
SA

Description

Use **Program 41-15 : ACD Queue Alarm Information** to assign the options for Audible Indication for Log Out/Off Duty mode for each ACD group.

These program settings provide an alarm to the agents, but no Queue Status Display is indicated. **Do not use these programs** if the alarm options are defined in Program 41-20-01 through 41-20-05.

Feature	Available in Program 41-15	Available in Program 41-20
Queue Status Display	---	Yes
Queue Status Display Time	---	Yes
Alarm	Yes	Yes
Alarm Send Time	Program 41-15-02 determines the length/interval of the alarm.	Yes
Interval Time of Queue Status Display		Yes
Class of Service	---	Yes
Timing of Alarm and Display Queue Status	Alarm triggered after the number of calls in Program 41-15-01 is exceeded.	Alarm triggered after the number of calls in Program 41-20-01 is exceeded. Then follows Program 41-20-03 time for displaying status.

Input Data

ACD Group No.	01~64
---------------	-------

Item No.	Item	Input Data	Default
01	Number of Calls in ACD Queue to Activate Alarm Information	0~200 0 = No Alarm	0
02	Interval Time of Alarm Information Input the alarm sound time.	0~64800 (sec)	0

Conditions

None

Feature Cross Reference

- Automatic Call Distribution (ACD)

Program 41 : ACD Setup

41-16 : ACD Threshold Overflow

Level:
SA

Description

Use **Program 41-16 : ACD Threshold Overflow** to define the value of the ACD threshold call overflow and the mode for each ACD group.

Input Data

ACD Group No.	01~64
---------------	-------

Item No.	Item	Input Data	Default
01	Number of Calls in Queue Define the maximum number of calls allowed in the ACD queue before overflow occurs.	0~200 0 = No Limitation	0
02	Operation Mode for ACD Queue Define how the system should handle calls when the number of calls in queue exceeds the threshold.	0 = The last waiting call is transferred 1 = The longest waiting call is transferred 2 = Send Busy Tone	0

Conditions

None

Feature Cross Reference

- Automatic Call Distribution (ACD)

Program 41 : ACD Setup

41-17 : ACD Login Mode Setup

Level:
SA

Description

Use **Program 41-17 : ACD Login Mode Setup** to define the ACD login mode for each extension. If the AIC Login Mode is enabled, set the AIC Login and AIC Logout service codes for the AIC members in Program 11-13-08 and 11-13-09.

Input Data

Extension Number	Up to eight digits
------------------	--------------------

Item No.	Login Mode	Default
01	0 = Normal Login Mode 1 = AIC Login Mode	0

Conditions

- If set to **1**, note that a supervisor cannot log in/out an AIC member as they are not normal ACD agents.

Feature Cross Reference

- Automatic Call Distribution (ACD)

Program 41 : ACD Setup

41-18 : ACD Agent Identity Code Setup

Level:
SA

Description

Use Program 41-18 : ACD Agent Identity Code Setup to define the ACD Agent Identity Code Table.

Input Data

AIC Table No.	001~512
---------------	---------

Item No.	Item	Input Data	Default
01	ACD Agent Identity Code	Up to four digits	No Setting
02	Default ACD Group Number	0~64 0 = No Setting	0
03	ACD Group Number in Mode 1	0~64 0 = No Setting	0
04	ACD Group Number in Mode 2	0~64 0 = No Setting	0
05	ACD Group Number in Mode 3	0~64 0 = No Setting	0
06	ACD Group Number in Mode 4	0~64 0 = No Setting	0
07	ACD Group Number in Mode 5	0~64 0 = No Setting	0
08	ACD Group Number in Mode 6	0~64 0 = No Setting	0
09	ACD Group Number in Mode 7	0~64 0 = No Setting	0
10	ACD Group Number in Mode 8	0~64 0 = No Setting	0

Conditions

None

Feature Cross Reference

None

Program 41 : ACD Setup

41-19 : ACD Voice Mail Delay Announcement

Level:
SA

Description

Use **Program 41-19 : ACD Voice Mail Delay Announcement** to assign VM8000 InMail Master Mailboxes (PRG 47-03) as ACD Delay Announcement Mailboxes.

Input Data

ACD Group Number	1 ~ 64
------------------	--------

Item No.	Item	Input Data	Default
01	Delay Message Start Timer Determine the time the system waits before playing the Delay Message.	0 ~ 64800 (sec)	0
02	Mailbox Number for 1st Announcement Message Assign the Voice Mail ACD Announcement Mailbox as the message source for the 1st Announcement Message.	Dial (up to eight digits)	No Setting
03	1st Delay Message Sending Count Determine the 1st Delay Message Sending Count. This entry must be set to 1 or higher for the message to play.	0 = No message is played. 1 ~ 255	0
04	Mailbox Number for 2nd Announcement Message Assign the Voice Mail ACD Announcement Mailboxes as the message source for the 2nd Announcement Message.	Dial (up to eight digits)	No Setting
05	2nd Delay Message Sending Count Determine the 2nd Delay Message Sending Count. This entry must be set to 1 or higher for the message to play.	0 = No message is played. 1 ~ 255	0
06	Wait Tone Type at Message Interval Determine what the caller hears between the messages.	0 = Ring Back Tone 1 = Music On Hold Tone 2 = Background Music Source	0
07	ACD Forced Disconnect Time after 2nd Announcement Assign the time the system should wait after the end of the ACD Delay Message before disconnecting.	0 ~ 64800 (sec)	0

Item No.	Item	Input Data	Default
08	Delay Message Interval Time Set the time for the interval between the Delay Messages.	0 ~ 64800 (sec)	20

Conditions

None

Feature Cross Reference

None

Program 41 : ACD Setup

41-20 : ACD Queue Display Settings

Level:
SA

Description

Use **Program 41-20 : ACD Queue Display Settings** to assign the options for the ACD Queue Status Display feature. This program allows the Queue Status Display, and causes an alarm to sound, when the parameters in this program are met.

Program 41-15 can also provide a queue alarm to the agents. The options in Program 41-20 should not be used if 41-15 is set.

Feature	Available in Program 41-15	Available in Program 41-20
Queue Status Display	---	Yes
Queue Status Display Time	---	Yes
Alarm	Yes	Yes
Alarm Send Time	Program 41-15-02 determines the length/interval of the alarm.	Yes
Interval Time of Queue Status Display		Yes
Class of Service	---	Yes
Timing of Alarm and Display Queue Status	Alarm triggered after the number of calls in Program 41-15-01 is exceeded.	Alarm triggered after the number of calls in Program 41-20-01 is exceeded. Then follows Program 41-20-03 time for displaying status.

Input Data

ACD Group No.	01~64
---------------	-------

Item No.	Item	Input Data	Default
01	Number of Calls in Queue Set the number of calls that can accumulate in the ACD queue before the Queue Status Display (and optional queue alarm) occurs.	0 = No Display, 1~200	0
02	Queue Status Display Time Set the time the Queue Status display remains on the telephone display.	0~64800 (sec)	5 (sec)
03	Queue Status Display Interval Set the time that refreshes the Queue Status Alarm time in queue display and causes the optional queue alarm to occur on phones active on a call, logged out, or in wrap-up.	0~64800 (sec)	60 (sec)
04	ACD Call Waiting Alarm Enable/Disable the queue alarm.	0 = Disable (Off) 1 = Enable (On)	0
05	ACD Call Waiting Alarm Hold Time Set the time the Call Waiting Alarm should sound.	0~64800 (sec)	0

Conditions

None

Feature Cross Reference

- Automatic Call Distribution (ACD)

THIS PAGE INTENTIONALLY LEFT BLANK

Program 42 : Hotel Setup

42-01 : System Options for Hotel/Motel

Level:
IN

Program

42

Description

Use **Program 42-01 : System Options for Hotel/Motel** to assign the system options for Hotel/Motel Service.

Input Data

Item No.	Item	Input Data	Default
01	Answering Message Mode for Wake Up Call (Hotel Mode)	0 = MOH (Hold Time) 1 = VRS Message 2 = VRS Message + Time	0
02	Wake Up Call Message Assignment VRS Message for Wake Up Calls. You must make an entry for this program if you have selected 1 or 2 in Item 01 above.	0~100 0 = No Setting	0
03	Wake Up Call No Answer	0 = No Transfer 1 = Transfer to the Operator	0
04	Setup Message Mode for Wake Up Call (Hotel Mode)	0 = Confirmation Tone 1 = VRS Message 2 = VRS Message + Time	0
05	Wake Up Call Message Assignment	0~100 0 = No Setting	0

Conditions

None

Feature Cross Reference

- Hotel/Motel

Program 42 : Hotel Setup

42-02 : Hotel/Motel Telephone Setup

Level:
IN

Description

Use **Program 42-02 : Hotel/Motel Telephone Setup** to define the basic operation of the Hotel/Motel extensions.

Input Data

Extension Number	Up to eight digits
------------------	--------------------

Item No.	Item	Input Data	Default
01	Hotel Mode If you want an extension to operate in the Hotel/Motel mode, enter 1. If you want the telephone to operate in the business mode, enter 0.	0 = Normal 1 = Hotel	0
02	Toll Restriction Class When Check In Assign an extension Toll Restriction Class when it is checked in. The system has 15 Toll Restriction Classes (1~15). The entry you make in this option affects the telephone in all Night Service modes. (Refer to Programs 21-05 and 21-06 to set up the Toll Restriction dialing options.) When the extension is checked out, it uses the Toll Restriction Class set in Program 21-04.	1~15	1

Conditions

None

Feature Cross Reference

- Hotel/Motel

Program 42 : Hotel Setup

42-03 : Class of Service Options (Hotel/Motel)

Level:
IN

Description

Use **Program 42-03 : Class of Service Options (Hotel/Motel)** to set the Hotel/Motel Class of Service (COS) options. Assign Class of Service to extensions in Program 42-02 : Hotel/Motel Telephone Setup. There are 15 Classes of Service. Refer to the following chart for a description of each COS option, its range and default setting. For additional Class of Service options, refer to Programs 20-06 ~ 20-14.

Input Data

Class of Service Number	01~15
-------------------------	-------

Item No.	Item	Input Data	Default	
			Class 01	Class 02~15
01	Check-In Operation	0 = Off 1 = On	0	0
02	Check-Out Operation	0 = Off 1 = On	0	0
03	Room Status Output	0 = Off 1 = On	0	0
04	DND Setting for Other Extension	0 = Off 1 = On	0	0
05	Wake up Call Setting for Other Extension	0 = Off 1 = On	0	0
06	Room Status Change for Other Extension	0 = Off 1 = On	0	0
07	Restriction Class Changing for Other Extension	0 = Off 1 = On	0	0
08	Room to Room Call Restriction	0 = Off 1 = On	0	0
09	DND Setting for Own Extension	0 = Off 1 = On	0	0

Item No.	Item	Input Data	Default	
			Class 01	Class 02~15
10	Wake Up Call Setting for Own Extension	0 = Off 1 = On	0	0
11	Change Room Status for Own Extension	0 = Off 1 = On	0	0
12	SLT Room Monitor Enable (1)/Disable (0) a single line telephone ability to use Room Monitor.	0 = Off 1 = On	0	0
13	PMS Restriction Level	0 = Off 1 = On	0	0

Conditions

None

Feature Cross Reference

- Class of Service
- Hotel/Motel

Program 42 : Hotel Setup

42-04 : Hotel Mode One-Digit Service Codes

Level:
IN

Description

Use **Program 42-04 : Hotel Mode One-Digit Service Codes** to set up the Hotel Mode one-digit service codes which are assigned in 42-02-01. For each Department Calling Group (1~64), you enter the destination for each single digit code (1~9, 0, *, #). The destination can be any code with up to four digits, such as an extension number or access code.

Input Data

Department (Extension) Group Number	01~64
-------------------------------------	-------

Item No.	Received Dial	Destination Number	Default
01	1~9,0,*,#	Up to eight digits	No Setting

Conditions

- The one-digit service codes you assign in this program wait until the interdigit time expires before executing.

Feature Cross Reference

- Hotel/Motel

Program 42 : Hotel Setup

42-05 : Hotel Room Status Printer

Level:
IN

Description

Use **Program 42-05 : Hotel Room Status Printer** to set the CTA port to output the Hotel Data (Check-Out sheet, Room Status, etc.) and the output options for the Hotel/Motel feature.

Input Data

Item No.	Item	Input Data	Default
01	Output Port Type	0 = No Setting 1 = CTA 3 = LAN	0
02	Output Destination Number	Up to eight digits (Extension number which CTA/CTU is equipped)	No Setting
03	Wake Up Call No Answer Data	0 = Not Output 1 = Output	0
04	Check-Out Sheet	0 = Not Output 1 = Output	0

Conditions

- Room Status Reports output via a CTA or CTU adapter require a DTH terminal and a compatible external device.
- Room Status Reports can be output via LAN port , or when using DTH terminals, a CTA or CTU adapter and a compatible external device.

Feature Cross Reference

- Hotel/Motel

Program 42 : Hotel Setup

42-06 : PMS Service Setting

Level:

IN

Description

Use **Program 42-06 : PMS Service Setting** to set the PMS integration settings when using PMS-U10 and PMS feature.

Input Data

Item No.	Item	Input Data	Default
01	PMS Port Number	0~65535	5129
02	3:00 AM Auto Room Scan Set maid required status for all checked-in rooms At 3:00 AM.	0 = Off 1 = On	0
03	CheckIn Message Type	0 = Off 1 = On	0
04	CheckOut Auto Status Change	0 = Off 1 = On	0
05	AREYUTHERE/LINETEST Send Timing	1~128 (sec)	10
06	AREYUTHERE/LINETEST Send Count	0~20 (times)	3

Conditions

None

Feature Cross Reference

- Hotel/Motel

Program 42 : Hotel Setup

42-07 : PMS Restriction Level Conversion Table

Level:
IN

Description

Use **Program 42-07 : PMS Restriction Level Conversion Table** to change the default Toll Restriction class on check in for a room (PRG 42-02-02).

Input Data

Restriction Level	0~3
-------------------	-----

Item No.	Item	Input Data	Default
01	PMS Restriction Level Conversion Table	1~15	Level 0 = 10 Level 1 = 11 Level 2 = 12 Level 3 = 13

Conditions

None

Feature Cross Reference

- Hotel/Motel

Program 44 : ARS/F-Route Setup

44-01 : System Options for ARS/F-Route

Level:
IN

Program

44

Description

Use **Program 44-01 : System Options for ARS/F-Route** to define the system options for the ARS/F-Route feature.

Input Data

Item No.	Item	Input Data	Default
01	ARS/F-Route Time Schedule If this option is set to 0 , the F-Route table selected is determined only by the digits dialed without any relation to the day or time of the call. If this option is set to 1 , the system first refers to Program 44-10. If there is a match, the pattern defined in that program is used. If not, the F-Route pattern in Program 44-09 and time setting in 44-08 are used.	0 = Not Used 1 = Used	0

Conditions

None

Feature Cross Reference

- Automatic Route Selection (ARS)
- Uniform Numbering Network

Program 44 : ARS/F-Route Setup

44-02 : Dial Analysis Table for ARS/F-Route Access

Level:

IN

Description

Use **Program 44-02 : Dial Analysis Table for ARS/F-Route Access** to set the Pre-Transaction Table for selecting ARS/F-Route.

Input Data

Dial Analysis Table Number	1~120
----------------------------	-------

Item No.	Item	Input Data	Default
01	<p>Dial</p> <p>Set the number of digits to be analyzed by the system for ARS routing.</p>	Up to eight digits (Use line key 1 for a Don't Care digit, @)	No Setting
02	<p>Service Type</p> <ul style="list-style-type: none"> ○ Service Type 1 (Extension Number) The number goes to an extension after deleting the front digit(s). <i>Additional Data</i> Assign the digit(s) to be deleted on top of the number for extension number usage. At least one digit must be deleted. ○ Service Type 2 (ARS/F-Route) The number is controlled by ARS/F-Route table. <i>Additional Data:</i> If the ARS/F-Route Time Schedule is not used, assign the ARS/F-Route table number for Program 44-05. If the ARS/F-Route Time Schedule is used, assign the ARS/F-Route selection number for Program 44-04. ○ Service Type 3 (Dial Extension Analyze Table) The total length of the number exceeds more than 8 digits. <i>Additional Data:</i> Assign the Dial Extension Analysis Table number to be used in Program 44-03. 	0 = No setting (None) 1 = Extension Call (Own) 2 = ARS/F-Route Table (F-Route) 3 = Dial Extension Analyze Table (Option)	0

Item No.	Item	Input Data	Default
03	<p>Additional Data</p> <p>For the Service Type selected in 44-02-02, enter the additional data required.</p> <ul style="list-style-type: none"> ○ 1: Delete Digit = 0~255 (255 = Delete All Digits) ○ 2: [Program 44-01 : 0] ARS/F-Route Table Number = 0~500 (0 = No Setting) Refer to Program 44-05. [Program 44-01 : 1] ARS/F-Route Select Table Number = 0~500 (0 = No Setting) Refer to Program 44-04. ○ 3: Dial Extension Analyze Table Number = 0~4 (0 = No Setting) Refer to Program 44-03. 	<p>1 = Delete Digit = 0~255 (255 : Delete All Digits)</p> <p>2 = 0~500 (0 = No Setting)</p> <p>3 = Dial Extension Analyze Table Number = 0~4 (0 = No Setting)</p>	0
04	<p>Dial Tone Simulation</p> <p>Enable to send dial tone to the calling party after the routing is determined. This may be required if the central office at the destination does not send dial tone.</p>	<p>0 = Off</p> <p>1 = On</p>	0

Conditions

None

Feature Cross Reference

- Automatic Route Selection (ARS)

Program 44 : ARS/F-Route Setup

44-03 : Dial Analysis Extension Table

Level:
IN

Description

When Program 44-02-02 is set to type 3, use **Program 44-03 : Dial Analysis Extension Table** to set the dial extension analysis table. These tables are used when the analyzed digits must be more than eight digits. If the received digits do not match the digits set in tables 1~250, table number 252 is used to refer to the next Extension Table Area (1~4) to be searched. If the received digits are not identified in tables 1~250, the F-Route selection table number defined in table 251 is used.

Input Data

Extension Table Area Number	1~4
Dial Analysis Table Number	1~252

Dial Analysis Table Number : 1~250

Item No.	Item	Input Data	Default
01	Dial	Up to 24 digits Digits = 1~9, 0, *, #, @ (Press Line Key 1 for wild character @)	No Setting
02	ARS/F-Route Select Table Number	0~500 (ARS/F-Route Table Number) With Program 44-01 set to 0, Program 44-05 is checked. With Program 44-01 set to 1, Program 44-04 is checked.	0

Dial Analysis Table Number : 251

Item No.	Item	Input Data	Default
03	ARS/F-Route Select Table Number	0~500 (ARS/F-Route Table Number) With Program 44-01 set to 0, Program 44-05 is checked. With Program 44-01 set to 1, Program 44-04 is checked.	0

Dial Analysis Table Number : 252

Item No.	Item	Input Data	Default
04	Next Table Area Number	0~4	0

Conditions

None

Feature Cross Reference

- Automatic Route Selection (ARS)

Program 44 : ARS/F-Route Setup

44-04 : ARS/F-Route Selection for Time Schedule

Level:
IN

Description

Use **Program 44-04 : ARS/F-Route Selection for Time Schedule** to assign each ARS/F-Route Selection number to an ARS/F-Route table number for each ARS/F-Route time mode. There are eight time modes for ARS/F-Route Access.

Input Data

ARS/F-Route Selection Number	1~500
------------------------------	-------

Item No.	ARS/F-Route Time Mode	ARS/F-Route Table Number	Default
01	1~8	0~500	0

Conditions

None

Feature Cross Reference

- Automatic Route Selection (ARS)

Program 44 : ARS/F-Route Setup

44-05 : ARS/F-Route Table

Level:
IN

Description

Use **Program 44-05 : ARS/F-Route Table** to set the ARS/F-Route table. There are four kinds of order. If the higher priority trunk groups are busy, the next order group is used. If a lower priority route is selected, the caller may be notified with a beep tone.

Input Data

ARS/F-Route Table Number	1~500
--------------------------	-------

Priority Number	1~4
-----------------	-----

Item No.	Item	Input Data	Default
01	Trunk Group Number Select the trunk group number to use for the outgoing ARS call.	0~100, 255 0 = No Setting 255 = Extension Call	0
02	Delete Digits Enter the number of digits to be deleted from the dialed number.	0~255 (255 = Delete All)	0
03	Additional Dial Number Table Enter the table number (defined in Program 44-06) for additional digits to be dialed.	0~1000	0
04	Beep Tone Select whether or not a beep is heard if a lower priority trunk group is used to dial out.	0 = Off 1 = On	0
05	Gain Table Number for Internal Calls Select the gain table number to use for the internal call (defined in Program 44-07).	0~500 0 = No Setting	0
06	Gain Table Number for Tandem Connections Select the gain table number to use for the tandem call (defined in Program 44-07).	0~500 0 = No Setting	0
07	ARS Class of Service Select the ARS Class of Service to use for the table. An extension ARS COS is determined in Program 26-04-01.	0~16	0

Item No.	Item	Input Data	Default
08	Dial Treatment Select the Dial Treatment to use for the table. If a Dial Treatment is selected, Programs 44-05-02 and 44-05-03 are ignored and the Dial Treatment defined in Program 26-03-01 is used instead.	0~15	0
09	Maximum Digit Input the maximum number of digits to send when using the F-Route.	0~24	0
10	CCIS over IP Destination Point Code Input the Destination Point Code to send when using this F-Route.	0~16367	0
11	Network Specified Parameter Table Enter a table number from Program 26-12.	0~16	0

Conditions

None

Feature Cross Reference

- Automatic Route Selection (ARS)

Program 44 : ARS/F-Route Setup

44-06 : Additional Dial Table

Level:

IN

Description

Use **Program 44-06 : Additional Dial Table** to set the additional dial table to add prior to the dialed ARS/F-Route number. The Additional Dial Table used is determined in Program 44-05-03.

Input Data

Additional Dial Table Number	1~1000
------------------------------	--------

Item No.	Additional Dial	Default
01	Up to 24 digits Enter: 1~9, 0, *, #, Pause (press LK 1 to enter a pause)	No Setting

Conditions

None

Feature Cross Reference

- Automatic Route Selection (ARS)

Program 44 : ARS/F-Route Setup

44-07 : Gain Table for ARS/F-Route Access

Level:
IN

Description

Use **Program 44-07 : Gain Table for ARS/F-Route Access** to set the gain/PAD table. If an extension dials ARS/F-Route number:

- The Extension Dial Gain Table, assigned in Program 44-05, is activated.
- The Extension Dial Gain Table follows Outgoing transmit and Outgoing receive settings.

If the incoming call is transferred to another line using ARS/F-Route:

- The Tandem Gain Table, assigned in Program 44-05, is activated.
- The Tandem Gain Table follows the Incoming transmit and Incoming receive settings for incoming line, and Outgoing transmit and Outgoing receive settings for the outgoing line.

 **For ARS/F-Route calls, the CODEC gains defined in Program 14-01-02 and 14-01-03 are not activated.**

Input Data

Gain Table Number	1~500
-------------------	-------

Item No.	Item	Input Data	Default
01	Incoming Transmit	1~63 (-15.5 ~ +15.5dB)	32 (0dB)
02	Incoming Receive	1~63 (-15.5 ~ +15.5dB)	32 (0dB)
03	Outgoing Transmit	1~63 (-15.5 ~ +15.5dB)	32 (0dB)
04	Outgoing Receive	1~63 (-15.5 ~ +15.5dB)	32 (0dB)

Conditions

None

Feature Cross Reference

- Automatic Route Selection (ARS)

Program 44 : ARS/F-Route Setup

44-08 : Time Schedule for ARS/F-Route

Level:
IN

Description

Use **Program 44-08 : Time Schedule for ARS/F-Route** to define the daily pattern of the ARS/F-Route feature. ARS/F-Route has 10 time patterns. These patterns are used in Program 44-09 and 44-10. The daily pattern consists of 20 time settings.

Input Data

Schedule Pattern Number	01~10
-------------------------	-------

Item No.	Time Number	Start Time	End Time	Mode
01	01~20	0000~2359	0000~2359	1~8

Default

All Schedule Patterns : 0:00 – 0:00, Mode 1

Example:

Pattern 1

0:00	8:00	18:00	22:00	0:00
Mode 3	Mode 1	Mode 2	Mode 3	

Time Number 01 : 00:00 – 08:00 Mode 3
 Time Number 02 : 08:00 – 18:00 Mode 1
 Time Number 03 : 18:00 – 22:00 Mode 2
 Time Number 04 : 22:00 – 00:00 Mode 3

Pattern 2

0:00	0:00
Mode 2	

Time Number 01 : 0:00 – 0:00 Mode 2

Conditions

None

Feature Cross Reference

- Automatic Route Selection (ARS)

Program 44 : ARS/F-Route Setup

44-09 : Weekly Schedule for ARS/F-Route

Level:
IN

Description

Use **Program 44-09 : Weekly Schedule for ARS/F-Route** to define a weekly schedule for using ARS/F-Route. The pattern number is defined in Program 44-08-01.

Input Data

Item No.	Day Number	Schedule Pattern Number	Default
01	1 = Sunday	1~10	Pattern 1
	2 = Monday	1~10	Pattern 1
	3 = Tuesday	1~10	Pattern 1
	4 = Wednesday	1~10	Pattern 1
	5 = Thursday	1~10	Pattern 1
	6 = Friday	1~10	Pattern 1
	7 = Saturday	1~10	Pattern 1

Conditions

None

Feature Cross Reference

- Automatic Route Selection (ARS)

Program 44 : ARS/F-Route Setup

44-10 : Holiday Schedule for ARS/F-Route

Level:
IN

Description

Use **Program 44-10 : Holiday Schedule for ARS/F-Route** to define a yearly schedule for ARS/F-Route. This schedule is used for setting special days such as national holidays. The pattern number is defined in Program 44-08-01.

Input Data

Item No.	Date	Schedule Pattern Number	Default
01	0101~1231	0~10 0 = No Setting	0

Conditions

None

Feature Cross Reference

- Automatic Route Selection (ARS)

THIS PAGE INTENTIONALLY LEFT BLANK

Program 45 : Voice Mail Integration

45-01 : Voice Mail Integration Options

Level:
IN

Program

45

Description

Use **Program 45-01 : Voice Mail Integration Options** to customize certain voice mail integration options.

Input Data

Item No.	Item	Input Data	Default
01	Voice Mail Department Group Number Assign Extension (Department) Group number as the voice mail group.	0~64 0 = No Voice Mail	0
02	Voice Mail Master Name Enter the Voice Mail Master Name.	Up to 12 Characters	VOICE MAIL
03	Voice Mail Call Screening Enable/Disable the ability to process the Call Screening commands (1+ extension number) sent from the Voice Mail. You should normally enable this option to allow for Voice Mail Call Screening. Disable this option if your system has been modified so that extensions begin with the digit 1 (e.g., 101, 102, etc.).	0 = Off 1 = On	0
04	Park and Page Enable/Disable the system ability to process the Voice Mail Park and Page (*) commands. You should normally enable this option.	0 = Off 1 = On	1
05	Message Wait Enable/Disable the system ability to process the Voice Mail Message Wait (#) commands. You should normally enable this option. If enabled, be sure that the programmed Message Notification strings don't contain the code for trunk access.	0 = Off 1 = On	1
06	Record Alert Tone Interval Time Set the time between Voice Mail Conversation Record alerts.	0~64800 (sec)	30

Input Data (Continued)

Item No.	Item	Input Data	Default
07	Centralized Voice Mail Pilot Number Assign this number the same as the extension number or pilot number.	Dial (up to eight digits)	No Setting
08	Centralized Voice Mail Department Group Number Assign which Extension (Department) Group Number is used as the Centralized Voice Mail group.	0~64	0
09	Centralized Voice Mail Master Name Assign the Centralized Voice Mail Master Name.	Up to 12 characters	"C.V.M."
10	New NSL Protocol support	0 = Off 1 = On	0
11	Prefix for Call Screening	Dial (One digit)	1
12	Prefix for Park and Page	Dial (One digit)	*
13	Prefix for Message Wait	Dial (One digit)	#
14	CCIS Centralized Voice Mail Number Assign the pilot number to Centralized Voice Mail over CCIS Link. This is assigned only in the remote switches.	Dial (up to eight digits)	No Setting
15	Analog Voice Mail Protocol Selection Assign whether fixed codes or the codes used in PRG 45-04 are used for analog voice mail protocol.	0: Fixed 1: Program	0
16	Voice Mail Fax Digit Add Assignment Assign up to four digits in front of the station number sent to the SLT port when a call is forwarded.	Up to four digits	None
17	Reply Mailbox Number Select whether or not to include the mailbox number in the analog voice mail protocol.	0: No 1: Yes	1
18	Trunk Number Mapping Assign the digits of trunk number mapping.	2~3	2

Conditions

None

Feature Cross Reference

- Voice Mail Integration (Analog)

Program 45 : Voice Mail Integration

45-02 : NSL Option Setup

Level:
IN

Description

Use **Program 45-02 : NSL Option Setup** to setup the NSL options for Voice Mail integration.

Input Data

Item No.	Item	Input Data	Default
01	Send DTMF tone or 6KD message	0 = Send DTMF tone to SLT-VM port 1 = Send 6KD message to Serial port	1
03	Send 51A Message	0 = Off 1 = On	1

Conditions

None

Feature Cross Reference

None

Program 45 : Voice Mail Integration

45-04 : Voice Mail Digit Add Assignment

Level:
IN

Description

Use **Program 45-04 : Voice Mail Digit Add Assignment** to define the digits to add.

Input Data

Item No.	Item	Input Data	Default
01	Remote Logon (Internal)	Up to four digits	None
02	Direct Logon	Up to four digits	None
03	Transfer Message	Up to four digits	None
04	Forward-All	Up to four digits	None
05	Forward-Busy	Up to four digits	None
06	Forward RNA	Up to four digits	None
07	Remote Logon	Up to four digits	None
08	Conversation Recording	Up to four digits	None
09	Clear Down String	Up to four digits	None

Conditions

None

Feature Cross Reference

None

Program 45 : Voice Mail Integration

45-05 : Voice Mail Send Protocol Signal Without Additional Digits

Level:
IN

Description

Use **Program 45-05 : Voice Mail Send Protocol Signal Without Additional Digits** to send trunk number and/or station number information if integrating to Voice Mail when PRG 45-04-XX is left blank and 45-01-15 is set to Program.

Input Data

Item No.	Item	Input Data	Default
01	Remote Log-On Internal	0 = Off 1 = On	0
02	Direct Log-On	0 = Off 1 = On	0
03	Transfer Message/QVM	0 = Off 1 = On	0
04	Forward-All	0 = Off 1 = On	0
05	Forward-Busy	0 = Off 1 = On	0
06	Forward RNA	0 = Off 1 = On	0
07	Remote Log-On	0 = Off 1 = On	0
08	Conversation Recording	0 = Off 1 = On	0
09	Clear Down String	0 = Off 1 = On	0

Conditions

None

Feature Cross Reference

None

Program 47 : In-Mail

47-01 : SV8100 InMail System Options

Level:
IN

Description

Use **Program 47-01 : SV8100 InMail System Options** to set up the SV8100 InMail system-wide options.

Input Data

Item No.	Item	Input Data	Default
02	<p>SV8100 InMail Master Name (MasterName)</p> <p>The CD-CP00-US must be reset for a change to this program to take effect.</p> <p>Modify the name for all UNIVERGE SV8100 VM8000 InMail ports. The system briefly displays this name when a display multiline terminal user calls a Voice Mail port (either by pressing Message, their voice mail key, or by dialing the master number). You should always end the name with the ## characters. The system substitutes the port number for the last #. Using the default name InMail ##, for example, the telephone display shows VM8000 InMail #1 when calling port 1.</p>	Up to 12 characters	InMail ## (The system substitutes the port number for the # when calling the port).

Program

47

Input Data

Item No.	Item	Input Data	Default
03	<p>Subscriber Message Length (Subs Msg Length) Set the maximum length of recorded messages for:</p> <ul style="list-style-type: none"> <input type="radio"/> Subscriber Mailbox users dialing RS to record and send a message. <input type="radio"/> Extension users leaving a message in a Subscriber Mailbox. <input type="radio"/> Outside Automated Attendant callers accessing a mailbox via a GOTO command and then dialing RS to record and send a message. <input type="radio"/> Subscriber Mailbox Greetings. <input type="radio"/> Announcement Messages. <input type="radio"/> Call Routing Mailbox Instruction Menus. <p> <i>The length of a Conversation Record is 10 times the Subscriber Message Length. Since the Conversation Record time cannot exceed 4095 seconds, any setting in Subscriber Message Length larger than 409 has no effect on the length of recorded conversations.</i></p>	1~4095 (sec)	120
04	<p>Non-Subscriber Message Length (Mbox Msg Length) Set the maximum length of recorded messages for:</p> <ul style="list-style-type: none"> <input type="radio"/> Automated Attendant callers leaving a message or Quick Message in a Subscriber Mailbox. <input type="radio"/> Outside callers transferred by an extension user to a Subscriber Mailbox. 	1~4095 (sec)	120

Input Data

Item No.	Item	Input Data	Default
05	<p>Message Backup/Go Ahead Time (Msg Bkup/Adv Time)</p> <p>Set the backup/go ahead time. This time sets how far SV8100 InMail backs up when a user dials B while listening to a message. This interval also sets how far SV8100 InMail jumps ahead when a user dials G while listening to a message.</p>	1~60 (sec)	5
07	<p>Digital Pager Callback Number (Pager CBack)</p> <p>Set the <i>Digital Pager Callback Number</i> portion of the Message Notification callout number for a digital pager. This is the portion of the callout number that is appended to the pager service telephone number. Normally, this option should be X*M#, where:</p> <ul style="list-style-type: none"> ○ X is the number of the extension that generated the notification. ○ * is a visual delimiter (to make the pager display easier to read). ○ M is the number of new messages in the extension mailbox. ○ # is the digit normally used by the pager service for positive disconnect. 	<p>Digits (12 maximum, using 0~9, # and *)</p> <p>M (Number of messages – entered by pressing LK1)</p> <p>X (Extension number – entered by pressing LK2)</p> <p>SV8100 InMail automatically replaces the X command with the number of the extension that initially received the message.</p>	X*M#

Input Data

Item No.	Item	Input Data	Default
08	<p>Delay in Dialing Digital Pager Callback Number</p> <p>(Pager Dial Delay)</p> <p>Set the delay that occurs just before SV8100 InMail dials the Digital Pager Callback Number portion of the Message Notification callout number for a digital pager. Set this delay so the pager service has enough time to connect to the digital pager before sending the callback number. Your pager service may be able to help you determine the best value for this option. When placing a digital pager notification, the system:</p> <p>Seizes the trunk specified.</p> <p>Dials the user-entered notification number (in Message + OP + N).</p> <p>Waits the 47-01-08: Delay in Dialing Digital Pager Callback Number interval.</p> <p>Dials the number entered in 47-01-07: Digital Pager Callback Number.</p> <p>The system assumes that the notification number completes dialing approximately 4 seconds after trunk seizure. This means that, by default, the Digital Pager Callback Number is dialed into the pager service about 13 seconds after trunk seizure.</p>	0~99 (sec)	30

Input Data

Item No.	Item	Input Data	Default
09	<p>Wait Between Digital Pager Callout Attempts (Notify Pager Intvl)</p> <p>Set the minimum time between unacknowledged or unanswered digital pager Message Notification callouts. (A subscriber acknowledges a digital pager notification by logging onto their mailbox.) After this time expires, SV8100 InMail tries the callout again (for up to the number of times set in 47-01-14: Number of Callout Attempts).</p> <p>If the system dials the callout number and the pager service is busy, it retries the number in one minute.</p>	1~255 (min)	15
10	<p>Wait Between Non-Pager Callout Attempts (Notify N-Pgr Intvl)</p> <p>Set the minimum time between non-pager Message Notification callouts in which the destination answers, says Hello, dials 1 to acknowledge and then enters the wrong security code.</p>	1~255 (min)	20
11	<p>Wait Between Busy Non-Pager Callout Attempts (Notify Busy Intvl)</p> <p>Set the time SV8100 InMail waits after it dials a busy non-pager callout destination, before retrying the callout number.</p>	1~255 (min)	15

Input Data

Item No.	Item	Input Data	Default
12	<p>Wait Between RNA Non-Pager Callout Attempts (Notify RNA Intvl)</p> <p>Set the time SV8100 InMail waits, after it dials an unanswered non-pager callout destination, before retrying the callout number.</p> <p>There are 3 types of unanswered non-pager callouts:</p> <ul style="list-style-type: none"> ○ If the callout rings the destination longer than the 47-01-13: Wait for Answer Non-Pager Callout Attempts option. ○ If the destination answers, says Hello (or the system detects answer supervision) and then hangs up without dialing 1 to log onto their mailbox. This typically happens if someone unfamiliar with notification answers the callout, or if the callout is picked up by an answering machine. ○ If the destination answers and then hangs up without saying Hello. This typically happens if someone unfamiliar with the notification answers the callout (like the above example), or if the call is picked up by an answering machine with insufficient outgoing message volume. 	1~255 (min)	30
13	<p>Wait for Answer Non-Pager Callout Attempts (Notify RNA Rings)</p> <p>If a non-pager callout rings the destination longer than this number of rings, SV8100 InMail marks the call as unanswered (Ring No Answer) and hangs up.</p>	1~99 (rings)	5

Input Data

Item No.	Item	Input Data	Default
14	<p>Number of Callout Attempts (Notify Call Atmpt)</p> <p>Set how many attempts SV8100 InMail retries an incomplete Message Notification callout. This total includes unacknowledged callouts, callouts to a busy destination, and callouts to an unanswered destination. This option applies to pager and non-pager callouts.</p>	1~99 (attempts)	5
15	<p>Send Pager Callout Until Acknowledged (Retry Until Ack)</p> <p>When this option is set to 1, SV8100 InMail continues to retry a digital pager Message Notification callout until the notification is acknowledged. If this option is disabled (0), SV8100 InMail retries a digital pager Message Notification the number of times specified in 47-01-14 Number of Callout Attempts. This option does not apply to Message Notification callouts to telephone numbers.</p> <p>A digital pager notification is considered acknowledged when the recipient logs onto the mailbox.</p>	0 = No (Disabled) 1 = Yes (Enabled)	0
16	<p>Name Format</p> <p>Specify if names are displayed in First Last format or Last First.</p>	0 = 1st Last 1 = Last 1st	0

Input Data

Item No.	Item	Input Data	Default
17	<p>InMail Port</p> <p>Specify the port number of the first InMail Port.</p> <p>With software version v1.11 or higher the following rules apply when programming VM8000.</p> <p>InMail ports in program 47-01-17 on a system that has the basic 64 port license:</p> <p>When a PZ-ME50-US is NOT mounted to CD-CP00-US:</p> <p>The first port of VM800 InMail must be assigned to port 57 or lower.</p> <p>The number of licensed VM8000 InMail ports do not take away from the 64 port license.</p> <p>There can still be a combination of 64 trunks, TDM phones and IP phones.</p> <p>When a PZ-ME50-US is mounted to CD-CP00-US:</p> <p>The first port of VM8000 InMail can be assigned above port 64.</p>	<p>0~497</p> <p>The first port of InMail must start with one of the following ports: 1, 5, 9, 12, 16,237, 241, 245, 249 and uses the first port assigned + next three consecutive ports.</p>	0
18	Play PAD Control	1~63 (-15dBm~ +15dBm)	32
19	Record PAD Control (for Networking)	1~63 (-15dBm~ +15dBm)	32

Conditions

- When changing 47-01-01 or 47-01-02, a system reset is required for the new setting to take affect.

Feature Cross Reference

None

Program 47 : In-Mail

47-02 : SV8100 InMail Station Mailbox Options

Level:
IN

Description

Use **47-02 : SV8100 InMail Station Mailbox Options** to set up a station/extension mailbox. Station mailboxes are automatically assigned as Subscriber Mailboxes. Normally, SV8100 InMail Station Mailbox numbers 1~26 should correspond to extensions 101~126.

 **Station Mailboxes are one of three mailbox categories: Station, Routing, or Master. You can also set up Master Mailboxes as Subscriber Mailboxes.**

Input Data

Station Mailbox Number	1~512
------------------------	-------

Input Data

Item No.	Item	Input Data	Default
01	<p>Mailbox Type</p> <p>Enable/Disable the mailbox. An extension mailbox is not accessible when it is disabled (even though its stored messages and configuration are retained in memory.) If disabled, a user pressing Message initiates a remote logon and is asked to enter their mailbox number. A voice prompt then announces: <i>"That mailbox does not exist."</i></p> <p>To make programming easier, consider associating a mailbox number with a station port. For example, mailbox 1 could correspond to port 1, which in turn corresponds to extension 101.</p>	0 = None 1 = Personal 2 = Group	1
02	<p>Mailbox Number</p> <p>Select the extension number associated with the mailbox you are programming. Normally, mailbox 1 should use Mailbox Number 101, mailbox 2 should use Mailbox Number 102, etc.</p> <p>To make programming easier, consider associating a mailbox number with a station port. For example, mailbox 1 could correspond to port 1, which in turn corresponds to extension 101.</p>	Digits (8 maximum, using 0~9)	Mailbox 1 = 101 Mailboxes 2~64 = 102~164 Mailboxes 65~512 = No entry

Input Data

Item No.	Item	Input Data	Default
03	<p>Number of Messages</p> <p>Set the maximum number of messages that can be left in the Subscriber Mailbox. If a caller tries to leave a message after this limit is reached, they hear: "That mailbox is full." SV8100 InMail then hangs up.</p>	<p>0~99 messages</p> <p>To conserve storage space, enter 0 for all unused mailboxes.</p>	<p>99 for mailbox 1</p> <p>20 for all other mailboxes</p>
04	<p>Message Playback Order</p> <p>Set the Subscriber Mailbox message playback order. When a subscriber listens to their messages, SV8100 InMail can play the oldest messages first , or the newest messages first.</p>	<p>0 = FIFO (first-in/first-out, or oldest messages first).</p> <p>1 = LIFO (last-in/first-out, or newest messages first)</p>	0
05	<p>Auto Erase/Save of Messages</p> <p>Determine what happens when a Subscriber Mailbox user completely listens to a new message and then exits the mailbox without either saving (SA) or erasing (E) the message. Depending on the setting of this option, SV8100 InMail either automatically saves or erases the message. If the mailbox user hangs up before listening to the <i>entire</i> new message, SV8100 InMail retains the message as a new message.</p>	<p>0 = Erase</p> <p>After the subscriber listens to the entire new message and hangs up, SV8100 InMail erases the message.</p> <p>1 = Save</p> <p>After the subscriber listens to the entire new message and hangs up, SV8100 InMail saves the message.</p>	1
06	<p>Message Retention</p> <p>Determine how long a Subscriber Mailbox retains held and saved messages. If a message is left in a Subscriber Mailbox longer than this interval, SV8100 InMail deletes it.</p>	<p>1~99 Days</p> <p>0 = Indefinite</p>	0

Input Data

Item No.	Item	Input Data	Default
07	<p>Recording Conversation Beep (Rec Conv Beep)</p> <p>Enable/Disable the Conversation Record beep. If enabled, all parties on a call hear the voice prompt "Recording", followed by a single beep when the extension user initiates Conversation Record. If disabled, the voice prompt and beep do not occur. When you disable the Conversation Record beep, the following voice prompts do not occur while SV8100 InMail records the conversation:</p> <p><i>Recording</i> (followed by a beep)</p> <p><i>That mailbox is full</i> (if the mailbox message storage capacity is reached)</p> <p><i>You have reached the recording limit</i> (if the recorded message is too long)</p> <p>The UNIVERGE SV8100 telephone system software provides an additional Conversation Record beep. This beep repeats according to the setting of Program 45-01-06: Voice Mail Integration Options: Record Alert Tone Interval Time (0~64800 seconds). To disable the UNIVERGE SV8100 telephone system Conversation Record beep, enter 0 for this option.</p>	<p>0 = No (Disable) 1 = Yes (Enable)</p>	1
08	<p>Message Waiting Lamp (Update MW Lamp)</p> <p>Enable/Disable Message Waiting lamps at the extension associated with the Subscriber mailbox. For Subscriber Mailboxes, enable this option. For Guest Mailboxes, disable this option.</p>	<p>0 = No (Disable) 1 = Yes (Enable)</p>	1
09	<p>Auto Attendant Direct to Voice Mail (Auto-ATT DND)</p> <p>Enable/Disable Auto Attendant Do Not Disturb. When a subscriber enables Auto Attendant Do Not Disturb, an Automated Attendant caller routes directly to the mailbox, hears the greeting, and is asked to leave a message. A subscriber also can enable Auto Attendant Do Not Disturb while recording their mailbox greeting.</p>	<p>0 = No (Disable) 1 = Yes (Enable)</p>	0
10	<p>Forced Unscreened Transfer (Forced UTRF)</p> <p>Enable/Disable Automated Attendant Forced Unscreened Transfer for the Subscriber Mailbox. If enabled, each Screened Transfer (TRF) to the extension is converted to an Unscreened Transfer (UTRF). If disabled, Screened Transfers from the Automated Attendant occur normally.</p>	<p>0 = No (Disable) 1 = Yes (Enable)</p>	0

Input Data

Item No.	Item	Input Data	Default
11	<p>Auto Time Stamp</p> <p>Enable/Disable Auto Time Stamp for the Subscriber Mailbox. If enabled, after the subscriber listens to a message SV8100 InMail announces the time and date the message was left. Auto Time Stamp also announces the message sender (if known).</p> <p>A subscriber also can enable Auto Time Stamp from their mailbox.</p>	<p>0 = No (Disable)</p> <p>1 = Yes (Enable)</p>	0
12	<p>System Administrator</p> <p>Designate the Subscriber Mailbox as a System Administrator. This allows the subscriber to use the SA options after logging onto their mailbox.</p>	<p>0 = No (Disable)</p> <p>1 = Yes (Enable)</p>	<p>Mailbox 1 (101)=1</p> <p>Other mailboxes=0</p>
13	<p>Dialing Option</p> <p>Provide additional dialing options for Next Call Routing Mailbox calls (see <i>Next Call Routing Mailbox</i> below). If enabled, a caller who accesses the Subscriber Mailbox to leave a message can dial any option in the Next Call Routing Mailbox Dial Action Table. If disabled, the caller can dial only 0 (to use the Next Call Routing Mailbox 0 action).</p>	<p>0 = No (Disable)</p> <p>1 = Yes (Enable)</p>	0
14	<p>Next Call Routing Mailbox (Next CR Mbox)</p> <p>Assign a Next Call Routing Mailbox to the Subscriber Mailbox. This provides callers with additional dialing options while listening to a Subscriber Mailbox recorded or default greeting. The digits the caller can dial depends on the setting of the Next Call Routing Mailbox and Alternate Next Call Routing Mailbox options.</p>	<p>Call Routing Mailbox Number (1~3 digits, 01~032)</p> <p>No entry (Entered by pressing CLEAR)</p>	<p>1 (Call Routing Mailbox 01)</p> <p>By default, Call Routing Mailbox numbers are 01~08.</p>
15	<p>Directory List Number</p>	<p>0 = None</p> <p>1~8 = List Number</p> <p>* = All</p>	0
16	<p>Voice Prompt Language</p>	<p>Refer to Table 2-10 47-02-16 Default Table</p>	1
17	<p>Enable Paging</p>	<p>0 = No (Disable)</p> <p>1 = Yes (Enable)</p>	0
18	<p>Paging Option</p>	<p>0 = RNA</p> <p>1 = Immediately</p>	0
19	<p>Telephone User Interface Type</p>	<p>0 = Numeric</p> <p>1 = Mnemonic</p>	0
20	<p>Enable E-mail Notification (Not supported in V2500 or lower)</p>	<p>0 = No</p> <p>1 = Yes</p>	0

Input Data

Item No.	Item	Input Data	Default
21	E-mail Address (Not supported in V2500 or lower)	Up to 48 characters	No Setting
22	Include Message as Attachment (Not supported in V2500 or lower)	0 = No 1 = Yes	0

Table 2-10 47-02-16 Default Table

Item	Name	Input Data
47-02-16	Voice Prompt Language	01 = US English
		02 = UK English
		03 = Australian English
		04 = French Canadian
		05 = Dutch
		06 = Mexican Spanish
		07 = Latin American Spanish
		08 = Italian
		09 = German
		10 = Madrid Spanish
		11 = Norwegian
		12 = Parisian French
		13 = Brazilian Portuguese
		14 = Japanese
		15 = Mandarin Chinese
		16 = Korean
		17 = Iberian Portuguese
		18 = Greek
		19 = Danish
		20 = Swedish
		21 = Thai
		22 = Mandarin Chinese (Taiwan)
		23 = Flemish

Conditions

None

Feature Cross Reference

None

Program 47 : In-Mail

47-03 : SV8100 InMail Group Mailbox Options

Level:

IN

Description

Use **47-03 : SV8100 InMail Group Mailbox Options** to set up the 32 Group Mailboxes (01~32). A Group Mailbox is used for Department Group overflow and can be a Subscriber or Call Routing.

Input Data

Group Mailbox Number	1~32
----------------------	------

Item No.	Item	Input Data	Default
02	Mailbox Number (Mailbox Number) The Group Mailbox Number is the same as the Department Group master (pilot) number. Select the Department Group master (pilot) number associated with the Group Mailbox you are programming.	Digits (eight maximum, using 0~9) No Setting (entered by pressing Hold)	No Setting
03	Mailbox Type (Mailbox Type) Set the Group Mailbox type.	0 = None 1 = Subscriber 2 = Routing	1

Conditions

None

Feature Cross Reference

None

Program 47 : In-Mail

47-06 : Group Mailbox Subscriber Options

Level:
IN

Description

Use **47-06 : Group Mailbox Subscriber Options** to set up a Master Mailbox assigned as a Subscriber Mailbox in 47-03-03: Master Mailbox Type.

Input Data

Item No.	Item	Input Data	Default
01	<p>Number of Messages</p> <p>Set the maximum number of messages that can be left in the Subscriber Mailbox. If a caller tries to leave a message after this limit is reached, they hear, "That mailbox is full." VM8000 InMail then hangs up.</p>	<p>0~99 messages</p> <p>To conserve storage space, enter 0 for all unused mailboxes.</p>	20
02	<p>Message Playback Order</p> <p>Set the Subscriber Mailbox message playback order. When a subscriber listens to their messages, VM8000 InMail can play the oldest messages first, or the newest messages first.</p>	<p>0 = FIFO (first-in/first-out, or oldest messages first).</p> <p>1 = LIFO (last-in/first-out, or newest messages first).</p>	0
03	<p>Auto Erase/Save of Messages</p> <p>Determine what happens when a Subscriber Mailbox user completely listens to a new message and then exits the mailbox without either saving (SA) or erasing (E) the message. Depending on the setting of this option, VM8000 InMail either automatically saves or erases the message. If the mailbox user hangs up before listening to the <i>entire</i> new message, VM8000 InMail retains the message as a new message.</p>	<p>0 = Erase</p> <p>After the subscriber listens to the entire new message and hangs up, SV8100 InMail erases the message.</p> <p>1 = Save</p> <p>After the subscriber listens to the entire new message and hangs up, SV8100 InMail saves the message.</p>	1
04	<p>Message Retention</p> <p>Determine how long a Subscriber Mailbox retains held and saved messages. If a message is left in a Subscriber Mailbox longer than this interval, VM8000 InMail deletes it.</p>	<p>1~90 days</p> <p>0 (Indefinite)</p>	0

Input Data

Item No.	Item	Input Data	Default
05	<p>Recording Conversation Beep (Rec Conv Beep)</p> <p>Enable/Disable the Conversation Record beep. If enabled, all parties on a call hear the voice prompt "Recording", followed by a single beep when the extension user initiates Conversation Record. If disabled, the voice prompt and beep do not occur. When you disable the Conversation Record beep, the following voice prompts do not occur while SV8100 InMail records the conversation:</p> <p><i>Recording (followed by a beep)</i></p> <p><i>That mailbox is full (if the mailbox message storage capacity is reached)</i></p> <p><i>You have reached the recording limit (if the recorded message is too long)</i></p> <p>The UNIVERGE SV8100 telephone system software provides an additional Conversation Record beep. This beep repeats according to the setting of Program 45-01-06: Voice Mail Integration Options: Record Alert Tone Interval Time (0~64800 seconds). To disable the UNIVERGE SV8100 telephone system Conversation Record beep, enter 0 for this option.</p>	<p>0 = No (Disable) 1 = Yes (Enable)</p>	1
06	<p>Message Waiting Lamp (Update MW Lamp)</p> <p>Enable/Disable Message Waiting light at the extension associated with the Subscriber mailbox. For Subscriber Mailboxes, enable this option. For Guest Mailboxes, disable this option.</p>	<p>0 = No (Disable) 1 = Yes (Enable)</p>	1
07	<p>Auto Attendant Direct to VoiceMail</p> <p>Enable/Disable Auto Attendant Direct to VM. When a subscriber enables Auto Attendant Direct to VM, an Automated Attendant caller routes directly to the mailbox, hears the greeting, and is asked to leave a message. A subscriber also can enable Auto Attendant Direct to VM while recording their mailbox greeting.</p>	<p>0 = No (Disable) 1 = Yes (Enable)</p>	0
08	<p>Forced Unscreened Transfer (Forced UTRF)</p> <p>Enable/Disable Automated Attendant Forced Unscreened Transfer for the Subscriber Mailbox. If enabled, each Screened Transfer (TRF) to the extension is converted to an Unscreened Transfer (UTRF). If disabled, Screened Transfers from the Automated Attendant occur normally.</p>	<p>0 = No (Disable) 1 = Yes (Enable)</p>	0

Input Data

Item No.	Item	Input Data	Default
09	<p>Auto Time Stamp</p> <p>Enable/Disable Auto Time Stamp for the Subscriber Mailbox. If enabled, after the subscriber listens to a message SV8100 InMail announces the time and date the message was left. Auto Time Stamp also announces the message sender (if known).</p> <p>A subscriber also can enable Auto Time Stamp from their mailbox.</p>	<p>0 = No (Disable)</p> <p>1 = Yes (Enable)</p>	0
10	<p>System Administrator</p> <p>(System Admin)</p> <p>Designate the Subscriber Mailbox as a System Administrator. This allows the subscriber to use the options after logging onto their mailbox.</p>	<p>0 = No (Disable)</p> <p>1 = Yes (Enable)</p>	0
11	<p>Dialing Option</p> <p>Provide additional dialing options for Next Call Routing Mailbox calls (see <i>Next Call Routing Mailbox</i> below). If enabled, a caller who accesses the Subscriber Mailbox to leave a message can dial any option in the Next Call Routing Mailbox Dial Action Table. If disabled, the caller can dial only 0 (to use the Next Call Routing Mailbox 0 action).</p>	<p>0 = No (Disable)</p> <p>1 = Yes (Enable)</p>	0
12	<p>Next Call Routing Mailbox</p> <p>(Next CR Mbox)</p> <p>Assign a Next Call Routing Mailbox to the Subscriber Mailbox. This provides callers with additional dialing options while listening to a Subscriber Mailbox recorded or default greeting. The digits the caller can dial depends on the setting of the Next Call Routing Mailbox and Alternate Next Call Routing Mailbox options.</p>	<p>Call Routing Mailbox Number (0~32)</p> <p>No entry (entered by pressing CLEAR)</p>	<p>1</p> <p>(Call Routing Mailbox 01)</p> <p>By default, Call Routing Mailbox numbers are 01=16.</p>
13	<p>Directory List Number</p> <p>Specify the Directory List number to which the Group Mailbox belongs.</p>	<p>0 = None</p> <p>1~8 = List Number</p> <p>* = All</p>	0
14	<p>Voice Prompt Language</p>	<p>Refer to Table 2-11 47-06-14 Default Table.</p>	1
15	<p>Enable Paging</p>	<p>0 = No</p> <p>1 = Yes</p>	0
16	<p>Paging Option</p>	<p>0 = RNA</p> <p>1 = Immediate</p>	0
17	<p>Telephone User Interface</p>	<p>0 = Numeric interface</p> <p>1 = Mnemonic interface</p>	0
18	<p>Enable E-mail Notification</p> <p>(not supported in V2500 or lower)</p>	<p>0 = No</p> <p>1 = Yes</p>	0

Input Data

Item No.	Item	Input Data	Default
19	E-mail Address (not supported in V2500 or lower)	Up to 48 characters.	No setting
20	Include Message as Attachment (not supported in V2500 or lower)	0 = No 1 = Yes	0

Table 2-11 47-06-14 Default Table

Item	Name	Input Data
47-06-14	Voice Prompt Language	01 = US English
		02 = UK English
		03 = Australian English
		04 = French Canadian
		05 = Dutch
		06 = Mexican Spanish
		07 = Latin American Spanish
		08 = Italian
		09 = German
		10 = Madrid Spanish
		11 = Norwegian
		12 = Parisian French
		13 = Brazilian Portuguese
		14 = Japanese
		15 = Mandarin Chinese
		16 = Korean
		17 = Iberian Portuguese
		18 = Greek
		19 = Danish
		20 = Swedish
		21 = Thai
		22 = Mandarin Chinese (Taiwan)
		23 = Flemish

Conditions

None

Feature Cross Reference

None

Program 47 : In-Mail

47-07 : SV8100 InMail Routing Mailbox Options

Level:

IN

Description

Use **47-07 : SV8100 InMail Routing Mailbox Options** to set up the 32 Routing Mailboxes. Routing Mailboxes can be either Announcement or Call Routing Mailboxes.

Input Data

Routing Mailbox Number	1~32
------------------------	------

Item No.	Item	Input Data	Default
02	Routing Mailbox Type (Mailbox Type) Set the Routing Mailbox type.	0 = None 1 = Call Routing 2 = Announcement 3 = Directory 4 = Distribution	Mailboxes 01~08 = 1 (Call Routing) Mailboxes 09~32 = 2 (Announcement)
03	Prompt Language	Refer to Table 2-12 47-07-03 Default Table	1
04	Telephone User Interface	0 = Numeric interface 1 = Mnemonic interface 2 = Octel (future)	0

Table 2-12 47-07-03 Default Table

Item	Name	Input Data
47-07-03	Voice Prompt Language	01 = US English
		02 = UK English
		03 = Australian English
		04 = French Canadian
		05 = Dutch
		06 = Mexican Spanish
		07 = Latin American Spanish
		08 = Italian
		09 = German
		10 = Madrid Spanish
		11 = Norwegian
		12 = Parisian French
		13 = Brazilian Portuguese
		14 = Japanese
		15 = Mandarin Chinese
		16 = Korean
		17 = Iberian Portuguese
		18 = Greek
		19 = Danish
		20 = Swedish
		21 = Thai
		22 = Mandarin Chinese (Taiwan)
		23 = Flemish

Conditions

None

Feature Cross Reference

None

Program 47 : In-Mail

47-08 : Call Routing Mailbox Options

Level:

IN

Description

Use **47-08 : Call Routing Mailbox Options** to set the options for mailboxes assigned as Call Routing Mailboxes in 47-07-02: Routing Mailbox Type.

Input Data

Routing Mailbox Number	1~32
------------------------	------

Item No.	Item	Input Data	Default
01	<p>Dial Action Table</p> <p>Assign the Dial Action Table to the Call Routing Mailbox. The Dial Action Table defines the dialing options for the call Routing Mailbox.</p>	1~16 (Dial Action Table 1~16)	1 (Dial Action Table 1)
02	<p>Screened Transfer Timeout</p> <p>(Scrn Trf Timeout)</p> <p>Set the time a Screened Transfer (TRF) from the Automated Attendant rings an unanswered extension before recalling.</p> <p>This option has a similar function as Customize: Mailbox Options: Call Routing: [Call Handling] Options: Delay Rings Before Redirect Transfer in SV8100 InMail.</p>	0~255 (sec) Entering 0 causes immediate recall.	15
03	<p>Time Limit for Dialing Commands</p> <p>(Dialing Timeout)</p> <p>Determine the time SV8100 InMail waits for an Automated Attendant caller to dial before routing the call to the Timeout destination.</p> <p><i>Be sure your Dial Action Tables have a Timeout action programmed.</i></p> <p>If the caller waits too long to dial:</p> <p><i>When the associated Dial Action Table has a Timeout action programmed, the caller routes to that destination.</i></p> <p><i>When the associated Dial Action Table does not have a Timeout action programmed, the Instruction Menu repeats three times and then SV8100 InMail hangs up.</i></p>	0~99 (sec) Entering 0 causes the Automated Attendant to immediately route callers to the Timeout destination programmed in the active Dial Action Table.	5

Item No.	Item	Input Data	Default
04	Fax Detection Enable/Disable Fax Detection for the Call Routing Mailbox. In enabled, the SV8100 InMail Automated Attendant (when using this Call Routing Mailbox) detects incoming fax CNG tone. The fax call then routes to the company fax machine according to the setting of 47-01-06 : <i>Fax Extension</i> . If disabled, the Automated Attendant does not detect incoming fax calls.	0 = No (Disable) 1 = Yes (Enable)	0
05	Fax Extension	Up to eight digits	No entry

Conditions

None

Feature Cross Reference

None

Program 47 : In-Mail

47-09 : Announcement Mailbox Options

Level:

IN

Description

Use **47-09 : Announcement Mailbox Options** to set the options for mailboxes assigned as Announcement Mailboxes in 47-07-02 : Routing Mailbox Type.

Input Data

Routing Mailbox Number	1~32
------------------------	------

Item No.	Item	Input Data	Default
01	<p>Next Call Routing Mailbox (Next CR Mbox)</p> <p>If you set up an Announcement Mailbox to answer Automated Attendant calls, provide additional routing options to the Automated Attendant callers. This option interacts with <i>Repeat Count</i> and <i>Hang Up After</i> below.</p> <p>For more detail on this interaction, refer to Direct Announcement Mailbox Routing and Routed Announcement Mailbox Routing in the SV8100 InMail System Guide.</p>	<p>Call Routing Mailbox Number (1~32)</p> <p>0 = Undefined</p>	0
02	<p>Repeat Count</p> <p>Enter the number of times you want the Announcement Mailbox message to repeat to callers. After an Announcement Mailbox caller initially listens to the message, it repeats the number of times specified in this option. This option interacts with <i>Next Call Routing Mailbox</i> and <i>Hang Up After</i> when providing routing options.</p> <p>For more detail on this interaction, refer to Direct Announcement Mailbox Routing and Routed Announcement Mailbox Routing in the SV8100 InMail System Guide.</p>	<p>0 (No Repeats)</p> <p>1~10 (Announcement repeats 1~10 times)</p>	0

Item No.	Item	Input Data	Default
03	Hang Up After (HangUp) Along with <i>Next Call Routing Mailbox</i> and <i>Repeat Count</i> above, provide additional routing options to Automated Attendant callers. For more detail on this interaction, refer to Direct Announcement Mailbox Routing and Routed Announcement Mailbox Routing in the SV8100 InMail System Guide.	0 = None 1 = Goodbye 2 = Silent	0

Conditions

None

Feature Cross Reference

None

Program 47 : In-Mail

47-10 : SV8100 InMail Trunk Options

Level:
IN

Description

Use **47-10 : SV8100 InMail Trunk Options** to assign SV8100 InMail options for each trunk. Currently, only 47-10-01: Answer Table Assignment is available.

Input Data

Trunk Port Number	1~200
-------------------	-------

Item No.	Item	Input Data	Default
01	Answer Table Assignment (Answer Table) Assign an SV8100 InMail Answer Table to each Direct Inward Line (DIL) the Automated Attendant should answer. The Automated Attendant follows the routing specified by the selected Answer Table.	Answer Table (1~8)	1
02	Record PAD Control	1~63 (-15dBm~ +15dBm)	32
03	Voice Prompt Language	Refer to Table 2-13 47-10-03 Default Table	1
04	Telephone User Interface	0 = Numeric interface 1 = Mnemonic interface 2 = Octel (future)	0

Table 2-13 47-10-03 Default Table

Item	Name	Input Data
47-10-03	Voice Prompt Language	01 = US English
		02 = UK English
		03 = Australian English
		04 = French Canadian
		05 = Dutch
		06 = Mexican Spanish
		07 = Latin American Spanish
		08 = Italian
		09 = German
		10 = Madrid Spanish
		11 = Norwegian
		12 = Parisian French
		13 = Brazilian Portuguese
		14 = Japanese
		15 = Mandarin Chinese
		16 = Korean
		17 = Iberian Portuguese
		18 = Greek
		19 = Danish
		20 = Swedish
		21 = Thai
		22 = Mandarin Chinese (Taiwan)
		23 = Flemish

Conditions

None

Feature Cross Reference

None

Program 47 : In-Mail

47-11 : VM8000 InMail Answer Table Options

Level:

IN

Description

Use **47-11 : VM8000 InMail Answer Table Options** to set options for the Answer Tables. VM8000 InMail provides eight Answer Tables (1~8). To set up the schedules for each Answer Table, go to **47-12 : SV8100 InMail Answer Table Schedule**.

Input Data

Answer Table Number	1~8
---------------------	-----

Input Data

Item No.	Item	Input Data	Default
01	Answer Schedule Override (Schedule Override) Enable/Disable Answer Schedule Override for the selected Answer Table. If enabled (and you make an entry for <i>Override Mailbox</i> below), the active Answer Table routes calls to the Override Mailbox.	0 = No (Disable) 1 = Yes (Enable)	0

Input Data

Item No.	Item	Input Data	Default
02	<p>Override Mailbox Category (Override MB Ctg)</p> <p>Specify the category of the mailbox where Automated Attendant calls should route when you enable Answer Schedule Override. SV8100 InMail mailbox categories are Subscriber Mailbox, Master Mailbox, and Routing Mailbox.</p> <p>SV8100 InMail handles the routing according to the type of mailbox (Subscriber, Call Routing, or Announcement) within the specified category:</p> <ul style="list-style-type: none"> ○ <i>If the Override Mailbox is a Subscriber Mailbox, the outside caller hears the mailbox greeting (if recorded) and can leave a message.</i> ○ <i>If the Override Mailbox is an Announcement Mailbox, the outside caller hears the recorded announcement. Depending on how the Announcement Mailbox is programmed, SV8100 InMail then hangs up, reroutes the call, or provides additional dialing options.</i> ○ <i>If the Override Mailbox is a Call Routing Mailbox, the outside caller hears the instruction menu and can dial any option allowed by the associated Dial Action Table.</i> <p> <i>If any of the Input Data values are entered, the terminal displays the Override Mailbox Number selection (below).</i></p>	<p>0 (Undefined)</p> <p>1 (Subscriber Mailbox – STA)</p> <p>2 (Group Mailbox)</p> <p>3 (Routing Mailbox)</p>	0
	<p>Override Mailbox Number (Override MB Num)</p> <p>Specify the mailbox where Automated Attendant calls should route when you enable Answer Schedule Override. The mailbox number you select in this option should match the mailbox category specified in 47-11-02: Override Mailbox Category above.</p>	<p>Digits (three maximum, using 0~9)</p>	No Entry

Input Data

Item No.	Item	Input Data	Default
03	<p>Default Mailbox Category (Default MB Ctg)</p> <p>Specify the category of mailbox used as the Default Mailbox. SV8100 InMail mailbox categories are Subscriber Mailbox, Master Mailbox, and Routing Mailbox. SV8100 InMail uses the Default Mailbox when an Answer Schedule is not in effect.</p> <p>SV8100 InMail handles the routing according to the type of mailbox (Subscriber, Call Routing, or Announcement) within the specified category:</p> <ul style="list-style-type: none"> ○ <i>If the Default Mailbox is a Subscriber Mailbox, the outside caller hears the mailbox greeting (if recorded) and can leave a message.</i> ○ <i>If the Default Mailbox is an Announcement Mailbox, the outside caller hears the recorded announcement. Depending on how the Announcement Mailbox is programmed, SV8100 InMail then hangs up, reroutes the call, or provides additional dialing options.</i> ○ <i>If the Default Mailbox is a Call Routing Mailbox, the outside caller hears the instruction menu and can dial any option allowed by the associated Dial Action Table.</i> <p> <i>If any of the Input Data values are entered, the terminal displays the Override Mailbox Number selection (below).</i></p>	<p>0 = Undefined)</p> <p>1 = Subscriber Mailbox (STA)</p> <p>2 = Group Mailbox</p> <p>3 = Routing Mailbox</p>	<p>Answer Table 1 = 3</p> <p>Answer Table 2~8 = 0</p>
	<p>Default Mailbox Number (Default MB Num)</p> <p>Set the Answer Table Default Mailbox number. SV8100 InMail uses the Default Mailbox when an Answer Schedule is not in effect. By default, this occurs at all times <i>other than</i> Monday through Friday from 8:30 AM to 5:00 PM.</p>	<p>Digits (Three maximum, using 0~9)</p>	<p>Answer Table 1 = 1</p> <p>Answer Table 2~8 = No Entry</p>
04	<p>Next Answer Table</p> <p>When 10 Answer Schedules in an Answer Table are not sufficient, link two Answer Tables together. SV8100 InMail treats the two linked tables as a single 20 entry Answer Table.</p>	<p>Answer Table (1~8)</p> <p>0 = Undefined</p>	<p>0</p>

Conditions

None

Feature Cross Reference

None

Program 47 : In-Mail

47-12 : VM8000 InMail Answer Schedules

Level:
IN

Description

Use **47-12 : VM8000 InMail Answer Schedules** to set up the SV8100 InMail Automated Attendant Answer Schedules. There are eight Answer Tables, with up to 10 Answer Schedules in each Answer Table.

Input Data

Item No.	Item	Input Data	Default
01	<p>Schedule Type (Entryxx Schedule Type) Assign a Schedule Type to the selected Answer Schedule. The Schedule Type determines how the Answer Schedule answers calls. The schedule can be one of the following types:</p> <ul style="list-style-type: none"> ○ 1. Day of the Week A Type 1 Answer Schedule runs on a specific day of the week. For this type of schedule, you select: <ul style="list-style-type: none"> ✓ The day of the week the schedule should run: ✓ The schedule start time. ✓ The schedule end time. ✓ The Call Routing or Announcement Mailbox used to answer calls. ○ 2. Range of Days A Type 2 Answer Schedule runs for a range of days. For this type of schedule, you select: <ul style="list-style-type: none"> ✓ The day of the week the schedule should start. ✓ The day of the week the schedule should stop. ✓ The time on the start day the schedule should start. ✓ The time on the stop day the schedule should stop. ✓ The Call Routing or Announcement Mailbox used to answer the calls. <p><i>(continued on next page)</i></p>	<p>0 = Undefined 1 = Day of the Week 2 = Range of Days 3 = Date</p>	<p>Answer Table 1/ Schedule 1 = 2 All other schedules = 0</p>

Input Data (Continued)

Item No.	Item	Input Data	Default
01	<p><i>(continued from previous page)</i></p> <ul style="list-style-type: none"> ○ 3. Date A type 3 Answer Schedule runs only on a specific day of the year. For this type of schedule, you select: <ul style="list-style-type: none"> ✓ The specific date the schedule should run. ✓ On the selected date, the time the schedule should start. ✓ On the selected date, the time the schedule should stop. ✓ The Call Routing or Announcement Mailbox used to answer the calls. 	<p>0 = Undefined 1 = Day of the Week 2 = Range of Days 3 = Date</p>	<p>Answer Table 1/ Schedule 1 = 2 All Other Schedules = 0</p>
02	<p>Answering Mailbox Category (Entryxx MB Ctg) Specify the category of mailbox to which Automated Attendant calls should route when the schedule is in effect. SV8100 InMail mailbox categories are Subscriber Mailbox, Master Mailbox, or Routing Mailbox. SV8100 InMail handles the routing according to the exact type of Subscriber, Master, or Routing Mailbox specified. If the Answering Mailbox is a Subscriber Mailbox, the outside caller hears the mailbox greeting (if recorded) and can leave a message. If the Answering Mailbox is an Announcement Mailbox, the outside caller hears the recorded announcement. Depending on how the Announcement Mailbox is programmed, SV8100 InMail then hangs up, reroutes the call, or provides additional dialing options. If the Answering Mailbox is a Call Routing Mailbox, the outside caller hears the instruction menu and can dial any option allowed by the associated Dial Action Table.</p> <p>Answering Mailbox Number (Entryxx MB Num) Set the number of the Answering Mailbox the Automated Attendant uses when the selected schedule is in effect. This mailbox is defined in 47-12-02: Answering Mailbox Category.</p>	<p>0 = Undefined 1 = Subscriber Mailbox - STA 2 = Group Mailbox 3 = Routing Mailbox</p> <p>Digits (three maximum, using 0~9)</p>	<p>3</p> <p>Answer Table 1/ Schedule 1 = 1 All Other Answer Schedules = No Entry</p>
03	<p>Day of the Week (Entryxx Day) For Day of the Week (Type 1) Answer Schedules, select the day of the week the Answer Schedule should be active.</p>	<p>1 = Sunday 2 = Monday 3 = Tuesday 4 = Wednesday 5 = Thursday 6 = Friday 7 = Saturday</p>	<p>1</p>

Input Data (Continued)

Item No.	Item	Input Data	Default
04	Start Day (Entryxx Start Day) For Range of Days (Type 2) Answer Schedules, select the day of the week the Answer Schedule should start.	1 = Sunday 2 = Monday 3 = Tuesday 4 = Wednesday 5 = Thursday 6 = Friday 7 = Saturday	1 Answer Table 1/ Schedule 1 = 2 All Other Schedules = 1
05	End Day (Entryxx End Day) For Range of Days (Type 2) Answer Schedules, select the day of the week the Answer Schedule should end.	1 = Sunday 2 = Monday 3 = Tuesday 4 = Wednesday 5 = Thursday 6 = Friday 7 = Saturday	Answer Table 1/ Schedule 1 = 6 All Other Answer Schedules = 1
06	Date (Entryxx Date) For Date (Type 3) Answer Schedules, select the date the Answer Schedule should be active.	MMDD For example: 0101 = January 1 1231 = December 31 0000 = No date set	0000
07	Schedule Start Time (Entryxx Start Time) Specify the time the Answer Schedule should start. It applies to Day of the Week (Type 1), Range of Days (Type 2), and Date (Type 3) schedules. (To make a schedule run continuously, make the same entry for 47-12-07: Schedule Start Time and 47-12-08: Schedule End Time.)	HHMM (24-hour clock) For example: 0130 = 1:30AM 1700 = 5:00PM	Answer Table 1/ Schedule 1 = 0830 (8:30AM) All other schedules are 0000.
08	Schedule End Time (Entryxx End Time) Specify the time the Answer Schedule should end. It applies to Day of the Week (Type 1), Range of Days (Type 2), and Date (Type 3) schedules. (To make a schedule run continuously, make the same entry for 47-12-07: Schedule Start Time and 47-12-08: Schedule End Time.)	HHMM (24-hour clock) For example: 0130 = 1:30AM 1700 = 5:00PM 0000 = Undefined	Answer Table 1/ Schedule 1 = 1700 All Other Schedules = 0000

Example

Type 1 (Day of the Week) Answer Schedule Options

Type 1 (Day of Week) Example

In this example, Answer Table 1 routes calls as follows:

- Schedule 1 uses Routing Mailbox 2 and runs Sunday from 8:30AM to 5:00PM.
- Schedule 2 uses Subscriber Mailbox 3 and runs Wednesday from 10:30AM to 5:00PM.
- Schedule 3 uses Routing Mailbox 4 and runs Tuesday from 9:00AM to 10:00AM.
- At all other times, routing is handled by the Default Mailbox specified in 47-11-03: Default Mailbox Category and 47-11-03: Default Mailbox Number.

When setting up Answer Tables with multiple types, build the Answer Schedules in the following order:

- Range of Days
- Day of Week
- Date

Type 1 (Day of Week) Example
Answer Table 1

Answer Schedule 1 Answer Schedule 1 is a Day of Week schedule that runs Sunday from 8:30AM to 5:00PM.	
	47-12-01: Entry01 Schedule Type = 1
	47-12-02: Entry01 MB Ctg = 3 47-12-02: Entry01 MB Num = 2
	47-12-03: Entry01 Day = 1
	47-12-04: Entry01 Start Day = 1 (Entry does not matter)
	47-12-05: Entry01 End Day = 1 (Entry does not matter)
	47-12-06: Entry01 Date (MMDD) = 0000 (Entry does not matter)
	47-12-07: Entry01 Start Time = 0830 (8:30AM)
	47-12-08: Entry01 End Time = 1700 (5:00PM)
Answer Schedule 2 Answer Schedule 2 is a Day of Week schedule that runs Wednesday from 10:30AM to 5:00PM.	
	47-12-01: Entry01 Schedule Type = 1
	47-12-02: Entry01 MB Ctg = 1 47-12-02: Entry01 MB Num = 3
	47-12-03: Entry01 Day = 4
	47-12-04: Entry01 Start Day = 1 (Entry does not matter)
	47-12-05: Entry01 End Day = 1 (Entry does not matter)
	47-12-06: Entry01 Date (MMDD) = 0000 (Entry does not matter)
	47-12-07: Entry01 Start Time = 1030 (10:30AM)
	47-12-08: Entry01 End Time = 1700 (5:00PM)
Answer Schedule 3 Answer Schedule 3 is a Day of Week schedule that runs Tuesday from 9:00AM to 10:00AM.	
	47-12-01: Entry01 Schedule Type = 1
	47-12-02: Entry01 MB Ctg = 3 47-12-02: Entry01 MB num = 4
	47-12-03: Entry01 Day = 3
	47-12-04: Entry01 Start Day = 1 (Entry does not matter)
	47-12-05: Entry01 End Day = 1 (Entry does not matter)
	47-12-06: Entry01 Date (MMDD) = 0000 (Entry does not matter)
	47-12-07: Entry01 Start Time = 0900 (9:00AM)
	47-12-08: Entry01 End Time = 1000 (10:00PM)

Type 2 (Range of Days) Answer Schedule Options**Type 2 (Range of Days) Example**

- In this example, Answer Table 1 routes calls as follows:
- Schedule 1 uses Routing Mailbox 1 and runs Sunday through Wednesday from 8:30AM to 5:00PM.
- Schedule 2 uses Routing Mailbox 2 and runs Thursday and Friday from 11:00AM to 1:00PM.
- At all other times, routing is handled by the Default Mailbox specified in 47-11-03: Default Mailbox Category and 47-11-03: Default Mailbox Number.

When setting up Answer Tables with multiple types, build the Answer Schedules in the following order:

- Range of Days
- Day of Week
- Date

Type 2 (Range of Days) Example	
Answer Table 1	
	Answer Schedule 1 Answer Schedule 1 is a Range of Days schedule that starts schedule that runs Sunday through Wednesday from 8:30AM to 5:00PM.
	47-12-01: Entry01 Schedule Type = 2
	47-12-02: Entry01 MB Ctg = 3 47-12-02: Entry01 MB Num = 1
	47-12-03: Entry01 Day = 1 (Entry does not matter)
	47-12-04: Entry01 Start Day = 1 (Sunday)
	47-12-05: Entry01 End Day = 4 (Wednesday)
	47-12-06: Entry01 Date (MMDD) = 0000 (Entry does not matter)
	47-12-07: Entry01 Start Time = 0830 (8:30AM)
	47-12-08: Entry01 End Time = 1700 (5:00PM)
	Answer Schedule 2 Answer Schedule 2 is a Range of Days schedule that runs Thursday and Friday from 11:00AM to 1:00PM.
	47-12-01: Entry01 Schedule Type = 2
	47-12-02: Entry01 MB Ctg = 3 47-12-02: Entry01 MB Num = 2
	47-12-03: Entry01 Day = 1 (Entry does not matter)
	47-12-04: Entry01 Start Day = 4 (Wednesday)
	47-12-05: Entry01 End Day = 5 (Thursday)
	47-12-06: Entry01 Date (MMDD) = 0000 (Entry does not matter)
	47-12-07: Entry01 Start Time = 1100 (11:00AM)
	47-12-08: Entry01 End Time = 1300 (1:00PM)

Type 3 (Date) Answer Schedule Options

Type 3 (Date) Example

In this example, Answer Table 1 routes calls as follows:

- Schedule 1 uses Routing Mailbox 1 and runs every day from 8:30AM to 5:00PM.
- Schedule 2 uses Routing Mailbox 9 and runs only on Christmas day from 8:30AM to 5:00PM.
- At all other times, routing is handled by the Default Mailbox specified in 47-11-03: Default Mailbox Category and 47-11-03: Default Mailbox Number.

When setting up Answer Tables with multiple types, build the Answer Schedules in the following order:

- Range of Days
- Day of Week
- Date

Type 3 (Date) Example	
Answer Table 1	
	Answer Schedule 1 Answer Schedule 1 is a Range of Days schedule that starts schedule that runs every day from 8:30AM to 5:00PM.
	47-12-01: Entry01 Schedule Type = 2
	47-12-02: Entry01 MB Ctg = 3 47-12-02: Entry01 MB Num = 1
	47-12-03: Entry01 Day = 1 (Entry does not matter)
	47-12-04: Entry01 Start Day = 1 (Sunday)
	47-12-05: Entry01 End Day = 1 (Sunday)
	47-12-06: Entry01 Date (MMDD) = 0000 (Entry does not matter)
	47-12-07: Entry01 Start Time = 0830 (8:30AM)
	47-12-08: Entry01 End Time = 1700 (5:00PM)
	Answer Schedule 2 Answer Schedule 2 is a Date schedule that runs only on Christmas day from 8:30AM to 5:00PM.
	47-12-01: Entry01 Schedule Type = 3
	47-12-02: Entry01 MB Ctg = 3 47-12-02: Entry01 MB Num = 9
	47-12-03: Entry01 Day = 1 (Entry does not matter)
	47-12-04: Entry01 Start Day = 1 (Entry does not matter)
	47-12-05: Entry01 End Day = 1 (Entry does not matter)
	47-12-06: Entry01 Date (MMDD) = 1225 (December 25, Christmas day)
47-12-07: Entry01 Start Time = 0830 (8:30AM)	
47-12-08: Entry01 End Time = 1700 (5:00PM)	

Conditions

None

Feature Cross Reference

None

Program 47 : In-Mail

47-13 : SV8100 InMail Dial Action Tables

Level:
IN

Description

Use **47-13 : SV8100 InMail Dial Action Tables** to set up the SV8100 InMail Dial Action Tables. The Dial Action Table defines the options than an Automated Attendant caller can dial. A Dial Action Table is associated with a Call Routing Mailbox, which is in turn associated with an Answer Table. When an Answer Table is active, its associated Call Routing Mailbox selects the Dial Action Table which provides dialing options to callers. The illustration below shows how this works in a default SV8100 InMail system. There are 16 Dial Action Tables.

InMail

Default Automated Attendant Answering

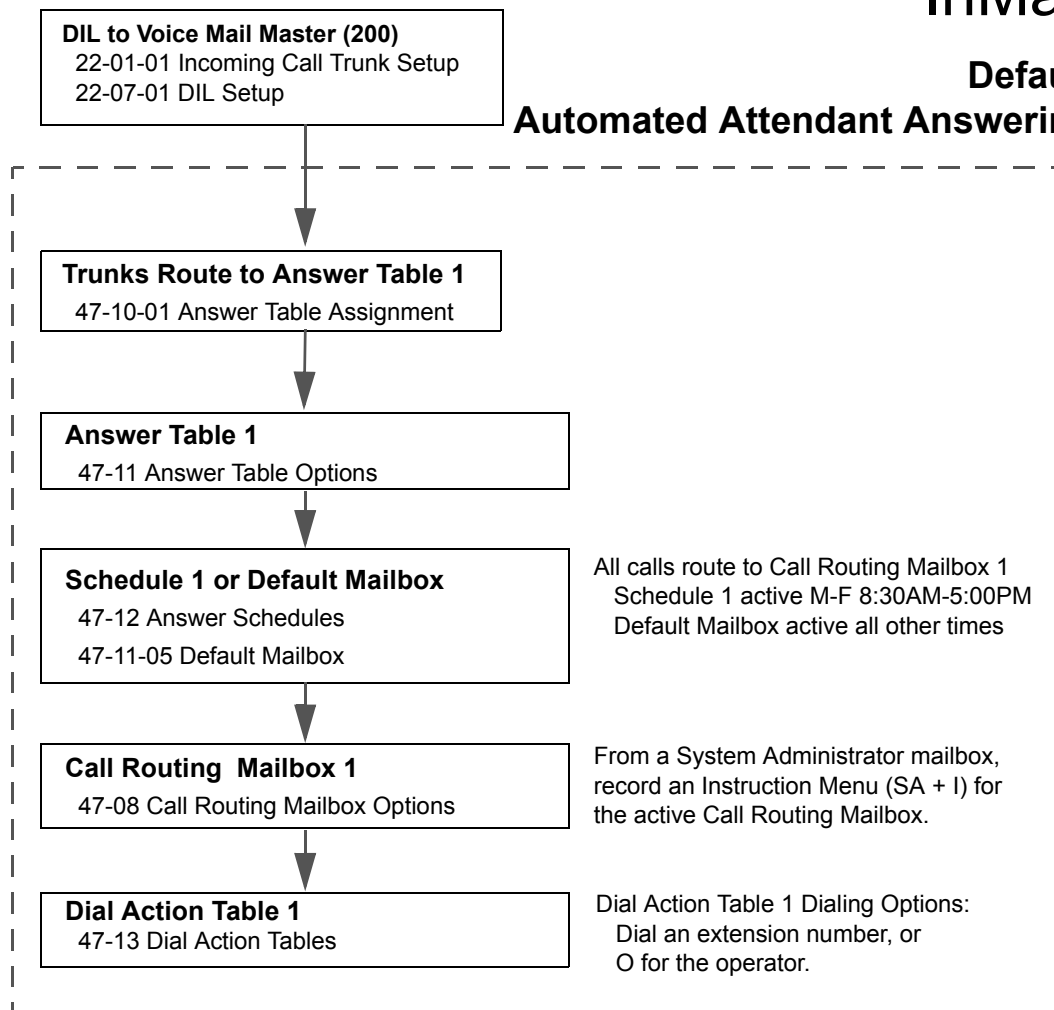

Dial Action Table Actions

❑ TRF Action - Screened Transfer (1) (TRF)

Use this action to allow an Automated Attendant caller to place a Screened Transfer to an extension. After an Automated Attendant caller dials an extension, SV8100 InMail calls (screens) the destination to see if the transfer can go through.

If the destination is available, the Automated Attendant rings it. If the destination answers, the call goes through.

If the destination does not answer during a preset interval, is busy, or is in Do Not Disturb, the Automated Attendant does not extend the call. It then provides the caller with additional options.

Number Option

Normally, the corresponding Number option should be XXX. Note that the key you choose for this action is the first digit of the called extension number.

For example, to allow callers to place Screened Transfers to extensions 301~399, for key 3 enter TRF for the *Action* and XXX for the corresponding *Number*.

To have Screened Transfer call a specific extension, the corresponding Number option should be that extension number. The caller then dials that single digit to reach the extension.

For example, to have callers dial 8 to reach extension 303, for key 8 enter TRF for the *Action* and 303 for the corresponding *Number*.

❑ UTRF Action – Unscreened Transfer (2) (UTRF)

Use this action to allow an Automated Attendant caller to place an Unscreened Transfer to an extension. This is similar to telephone system unscreened transfers in which the transferring party immediately extends the call. After an Automated Attendant caller dials an extension, SV8100 InMail transfers the call to the destination and hangs up. Any recalls or additional routing are handled by the telephone system – just as with any other unscreened transfer.

Number Option

Normally, the corresponding Number option should be XXX. Note that the key you choose for this action is the first digit of the called extension number.

For example, to allow callers to place Unscreened Transfers to extensions 301~399, for key 3 enter UTRF for the *Action* and XXX for the corresponding *Number*.

To have Unscreened Transfer call a specific extension, the corresponding Number option should be that extension number. The caller then dials that single digit to reach the extension.

For example, to have callers dial 8 to reach extension 303, for key 8 enter UTRF for the *Action* and 303 for the corresponding *Number*.

❑ **REC1 Action – Quick Message With Greeting (3) (REC1)**

Use this action to allow an Automated Attendant caller to leave a Quick Message at an extension. With this action, the caller hears the extension greeting prior to leaving the message.

Number Options

To have the caller leave a quick Message at a specific extension, the corresponding Number option should be the extension number.

To have the caller leave a Quick Message at any caller-dialed extension, the corresponding Number option should be IXXX.

To have the caller leave a Quick Message at a caller-dialed extension in a specific range, the corresponding Number option should be XXX.

For example, to allow callers to leave a Quick Message extensions 301~399, for key 3 enter REC1 for the *Action* and XXX for the corresponding *Number*.

❑ **REC2 Action – Quick Message Without Greeting (4) (REC2)**

Use this action to allow an Automated Attendant caller to leave a Quick Message at an extension. With this action, the caller *does not* hear the extension greeting prior to leaving the message. Instead, the caller hears the voice prompt *Recording* followed by a beep.

Number Option

To have the caller leave a quick Message at a specific extension, the corresponding Number option should be the extension number.

To have the caller leave a Quick Message at any caller-dialed extension, the corresponding Number option should be IXXX.

To have the caller leave a Quick Message at a caller-dialed extension in a specific range, the corresponding Number option should be XXX.

For example, to allow callers to leave a Quick Message extensions 301~399, for key 3 enter REC2 for the *Action* and XXX for the corresponding *Number*.

❑ **LOGON Action – Log Onto Voice Mail (5) (LOGON)**

Use this key action to allow an Automated Attendant caller to log onto Voice Mail. Depending on programming (see *Number Option* below), the caller is logged directly into a Subscriber Mailbox or is prompted to enter a Subscriber Mailbox of their own choosing. **You cannot use the LOGON option with Call Routing and Announcement Mailboxes.**

Number Option

To log directly into a specific Subscriber Mailbox, enter the **mailbox number** in the corresponding Number option.

For example, to have key 4 log directly into Subscriber Mailbox 305, for key 4 enter LOGON for the *Action* and 305 for the corresponding *Number*.

To have SV8100 InMail request Automated Attendant callers to select a Subscriber Mailbox to log into, enter **N** in the corresponding Number option. The key you choose must represent the first digit in the Subscriber Mailbox numbers.

For example, to have the Automated Attendant request callers enter the number of the Subscriber Mailbox where they want to log into, for key 3 enter LOGON for the *Action* and N for the corresponding *Number*. When callers dial 3, they hear, *Please enter your mailbox number*.

To have SV8100 InMail require Automated Attendant callers to enter a Subscriber Mailbox to log into (without playing an announcement), enter **XXX** in the corresponding Number option. The key you choose must represent the first digit in the Subscriber Mailbox numbers.

For example, to allow callers to log onto mailboxes 301~399, for key 3 enter LOGON for the *Action* and XXX for the corresponding *Number*.

To log into **any** valid Subscriber Mailbox, enter **IXXX** in the corresponding Number option.

For example, to allow callers to dial 1 plus any Subscriber Mailbox number to log on, for key 1 enter LOGON for the *Action* and IXXX for the corresponding *Number*.

❑ **Hang Up Action (6) (HNGUP)**

When an Automated Attendant caller presses a key assigned to this action, SV8100 InMail says *Goodbye* and immediately hangs up.

Number Option

No entry is required in the corresponding Number Option.

❑ **GOTO Action – Go to Mailbox (7) (GOTO)**

Use this option to provide Automated Attendant callers with the ability to route to Call Routing and Announcement Mailboxes. For example, a caller can dial a digit for Sales, and then go to the Call Routing or Announcement Mailbox that provides the dialing options and instructions for Sales.

Number Option

To have Automated Attendant callers dial a single digit to go to a Call Routing or Announcement Mailbox, enter the **mailbox number** in the corresponding Number option.

For example, to have key 1 go to Call Routing Mailbox 01, for key 1 enter GOTO for the *Action* and 01 for the corresponding *Number*.

To have SV8100 InMail require Automated Attendant callers to enter a Call Routing or Announcement Mailbox to go to, enter **XXX** in the corresponding Number option. The key you choose must represent the first digit in the mailbox number.

For example, to allow callers to go to mailboxes 000~015, for key 0 enter GOTO for the *Action* and XXX for the corresponding *Number*.

To log into **any** valid Call Routing or Subscriber Mailbox, enter **IXXX** in the corresponding Number option.

For example, to allow callers to dial 1 plus any Call Routing or Announcement Mailbox number to go to, for key 1 enter GOTO for the *Action* and IXXX for the corresponding *Number*.

❑ **UND Action – Undefined Routing (0) (UND)**

Use this key action if you want a key to have no routing (no operation). When an Automated Attendant caller presses an undefined key, they hear, *That is an invalid entry*. The caller can then dial another option.

Input Data

Dial Action Table Number	01~16
--------------------------	-------

Key No.	Dial Action Table Action	Additional Data
1	<input type="radio"/> TRF Action - Screened Transfer (1) (TRF)	<input type="radio"/> Digits Entry : 0-9, #, and * (8 digits max.) Use Dial Action Table digits to route an Automated Attendant call to a specific location (such as an extension). For example, to set up a TRF Action to route to extension 305, for 3 enter TRF for the <i>Action</i> and 305 for the corresponding <i>Number</i> . <input type="radio"/> Caller Dialed Digits Entry : X (Entered by pressing LK2) Use the X option to route an Automated Attendant call based on digits the caller dials. Each X entry represents one caller-dialed digit. For example, to set up a TRF Action to route to any caller dialed extension in the 301'399 range, for 3 enter TRF for the <i>Action</i> and XXX for the corresponding <i>Number</i> . <input type="radio"/> Ignore Digits Entry : I (Entered by pressing LK3) Use the I option to represent any digit dialed by the Automated Attendant caller that SV8100 InMail ignores for routing. An example of this is REC action assigned to the * key in Dial Action Table 1 by default. The <i>Action</i> is REC2 and the <i>Number</i> is IXXX. This means that a caller can dial * + any mailbox number to leave a Quick Message in that mailbox. SV8100 InMail ignores the first digit dialed by the caller (*), and routes according to the next 3 digits dialed. <input type="radio"/> No Routing Entry : N (Entered by pressing LK1) Use the N option when you want no Automated Attendant routing to automatically occur. This can be used with the LOGON action when you want to prompt the caller to enter a mailbox number. To do this for the # key (for example), for the # key enter LOGON for the <i>Action</i> and N for the corresponding <i>Number</i> . When the caller dials #, they hear, <i>Please enter the mailbox number. Or, to exit, press the pound key.</i> <input type="radio"/> Pause Entry : P (Entered by pressing LK4) Use the P option when you want the Automated Attendant to pause while dialing.
2	<input type="radio"/> UTRF Action - Unscreened Transfer (2) (UTRF)	
3	<input type="radio"/> REC1 Action - Quick Message With Greeting (3) (REC1)	
4	<input type="radio"/> REC2 Action - Quick Message Without Greeting (4) (REC2)	
5	<input type="radio"/> LOGON Action - Log Onto Voice Mail (5) (LOGON)	
6	<input type="radio"/> Hang Up Action (6) (HNGUP)	
7	<input type="radio"/> GOTO Action - Go to Mailbox (7) (GOTO)	
8	<input type="radio"/> UND Action - Undefined Routing (0) (UND)	
9		
0		
*		
#		
TIMEOUT		

Conditions

None

Defaults

Dial Action Table Default Settings		
Key	Dial Action Table 1	Dial Action Tables 2~16
1	UTRF to XXX (Unscreened Transfer to user-dialed extension)	UND (Undefined)
2	UND (Undefined)	UND (Undefined)
3	UTRF to XXXX (Unscreened Transfer to user-dialed extension)	UND (Undefined)
4	UND (Undefined)	UND (Undefined)
5	UND (Undefined)	UND (Undefined)
6	UND (Undefined)	UND (Undefined)
7	UND (Undefined)	UND (Undefined)
8	UND (Undefined)	UND (Undefined)
9	HNGUP (Hangup)	UND (Undefined)
0	UTRF to 101 (Unscreened Transfer to 101)	UND (Undefined)
*	REC1 to IXXX (Quick Message with greeting to user-dialed extension)	UND (Undefined)
#	LOGON to IXXX (Logon to user-dialed mailbox)	UND (Undefined)
TIMEOUT	UTRF to 101 (Unscreened Transfer to 101)	UND (Undefined)



TIMEOUT provides the routing for rotary dial callers.

Feature Cross Reference

None

Program 47 : In-Mail

47-15 : Routing Directory Mailbox Options

Level:

IN

Description

Use **47-15 : Routing Directory Mailbox Options** to define the Routing Directory Mailbox Options. This data is referred if Program 47-07-02 (Routing Master Mailbox Type) was set to Type 4 (Directory).

Input Data

Master Mailbox Number	1~32
-----------------------	------

Item No.	Item	Input Data	Default
01	Minimum Number of Letters Required	1~3	1
02	Directory List Number to Use	1~8	1
03	Name Match	0 = First 1 = Last	0
04	Transfer Option	0 = TRF 1 = UTRF	0
05	Screened Transfer Timeout	0~255	15
06	Time Limit for Dialing Commands	0~99	5
07	Fax Detection	0 = Disable 1 = Enable	0
08	Next Call Routing Mailbox	0~32	0
09	Fax Extension	Up to eight digits	No entry

Conditions

None

Feature Cross Reference

None

Program 47 : In-Mail

47-16 : InMail Language License

Level:
IN

Description

Use **47-16 : InMail Language License** to define the language order InMail uses. Depending on the language license number, InMail uses the languages defined starting from Language 1. For example, if the system has a two language license InMail uses the language defined as Language 1 and 2 in the provided default table.

Input Data

Language	1~20
----------	------

Item No.	Item	Input Data	Default
01	Language License	01 = US English	Refer to Table 2-14 47- 16-01 Default Table
		02 = UK English	
		03 = Australian English	
		04 = French Canadian	
		05 = Dutch	
		06 = Mexican Spanish	
		07 = Latin American Spanish	
		08 = Italian	
		09 = German	
		10 = Madrid Spanish	
		11 = Norwegian	
		12 = Parisian French	
		13 = Brazilian Portuguese	
		14 = Japanese	
		15 = Mandarin Chinese	
		16 = Korean	
		17 = Iberian Portuguese	
		18 = Greek	
		19 = Danish	
		20 = Swedish	

Item No.	Item	Input Data	Default
		21 = Thai	
		22 = Mandarin Chinese (Taiwan)	
		23 = Flemish	

Table 2-14 47-16-01 Default Table

Language No.	47-16-01 Default
Language 1	01 (US English)
Language 2	04 (French Canadian)
Language 3	06 (Mexican Spanish)
Language 4	00 (No entry)
Language 5	00 (No entry)
Language 6	00 (No entry)
Language 7	00 (No entry)
Language 8	00 (No entry)
Language 9	00 (No entry)
Language 10	00 (No entry)
Language 11	00 (No entry)
Language 12	00 (No entry)
Language 13	00 (No entry)
Language 14	00 (No entry)
Language 15	00 (No entry)
Language 16	00 (No entry)
Language 17	00 (No entry)
Language 18	00 (No entry)
Language 19	00 (No entry)
Language 20	00 (No entry)

Conditions

None

Feature Cross Reference

None

Program 47 : In-Mail

47-17 : Routing Distribution Mailbox Options

Level:

IN

Description

Use **47-17 : Routing Distribution Mailbox Options** to assign data when Program 47-07-02 is set to 4 (Distribution).

Input Data

Routing Mailbox Number	1~32
------------------------	------

Input Data

Entry Number	1~20
--------------	------

Item No.	Item	Input Data	Default
01	Distribution Mailbox Category Use Undefined (0) to skip Mailbox Number setting. Use Station Mailbox (1) for setting Mailbox Number to 1~512 (PRG 47-02). Use Group Number (2) for setting Group Mailbox (1~32) (PRG 47-03).	0 = Undefined 1 = Station Mailbox 2 = Group Mailbox	0
	Distribution Mailbox Number	Up to three digits	

Conditions

None

Feature Cross Reference

None

Program 47 : In-Mail

47-18 : VM8000 InMail SMTP Setup

Level:

IN

Description

Use **47-18 VM8000 InMail SMTP Setup** to set the SNMP e-mail notification.

(Not supported in V2500 or lower)

Item No.	Item	Input Data	Default
01	SMTP Enabled	0 = No 1 = Yes	0
02	Server Name	Up to 48 characters	No Setting
03	SMTP Port	0~65535	25
04	Encryption	0 = No 1 = Yes	0
05	Authentication	0 = No 1 = Yes 2 = POP3	0
06	User Name	Up to 48 characters	No Setting
07	Password	Up to 48 characters	No Setting
08	E-mail Address	Up to 48 characters	No Setting
09	Reply to Address	Up to 48 characters	No Setting

Conditions

None

Feature Cross Reference

None

Program 47 : In-Mail

47-19 : VM8000 InMail POP3 Setup

Level:
IN

Description

Use **47-19 : VM8000 InMail POP3 Setup** to set the InMail e-mail notification.

(Not supported in V2500 or lower)

Item No.	Item	Input Data	Default
01	Server Name	Up to 48 characters	No Setting
02	POP3 Port	0~65535	110
03	Encryption	0 = No 1 = Yes	0
04	User Name	Up to 48 characters	No Setting
05	Password	Up to 48 characters	No Setting

Conditions

None

Feature Cross Reference

None

Program 50 : Common Channel Interoffice Signaling Service

50-01 : CCIS System Setting

Level:
IN

Program

50

Description

Use **Program 50-01 : CCIS System Setting** to set the availability of CCIS in the UNIVERGE SV8100. No other CCIS settings function if this program is disabled.

Input Data

Item No.	Item	Input Data	Default
01	CCIS Availability	0 = Disable 1 = Enable	0

Conditions

None

Feature Cross Reference

None

Program 50 : Common Channel Interoffice Signaling Service

50-02 : Connecting System Settings

Level:
IN

Description

Use **Program 50-02 : Connecting System Settings** to define the settings for each CCIS Route ID.

Input Data

CCIS Route ID	Route ID 1~8: CCIS via DTI Route ID 9: CCIS via IAD/CD-PVAA (IP-CCIS)
---------------	--

Item No.	Item	Description	Input Data	Default
01	Port Number of Common Signaling Channel (T1)	Specify the Trunk port to send D-channel information. This program is available for using DTI package.	0~200	0
02	Common Signaling Channel Data Speed Assignment (T1)	Assign the baud rate of Common Signaling Channel on DTI package.	0 = 64Kbps 1 = 56Kbps 2 = 48Kbps(1) 3 = 48Kbps(2)	1
03	Originating Point Code	Assign the Point Code of own side.	0~16367	0
04	Destination Point Code (T1)	Assign the Point Code of destination side on the DTI link.	0~16367	0
05	Calling Name Indication (T1)	Calling name indication is not sent to destination party if switch is set to 0.	0 = Disable 1 = Enable	1
06	--- Not Used ---			

Conditions

- If 56K K-CCIS is used, 24 Multi-Frame (ESF) must be assigned in Program 10-03-02.
- DPC must be what the OPC is on the opposite side of the link.

Feature Cross Reference

None

Program 50 : Common Channel Interoffice Signaling Service

50-03 : CCIS Destination System Settings

Level:
IN

Description

Use **Program 50-03 : CCIS Destination System Settings** to assign information of remote systems in a CCIS Network.

Input Data

CCIS System ID	1~255
----------------	-------

Item No.	Item	Description	Input Data	Default
01	Destination Point Code	Define the Point Code at the Destination Party.	0~16367	0
02	CCIS Route ID (T1 only)	Select the CCIS Route ID defined in Program 14-13 when the user tries to access the system in a CCIS network.	0~8 (CCIS Route IDs 5~8 are for future use and should not be used.)	0
03	IP Address (IP only)	Assign the IP Address to a CCIS System ID.	xxx.xxx.xxx.xxx (xxx = 0~255)	0.0.0.0
04	Point Code Availability	Define if the system associated with Destination Code can be Reached (1) or Not Reached (0). If set to 0, when using the IP-CCIS, that system cannot be called until it is set to 1.	0 = Disable 1 = Enable	1

Conditions

None

Feature Cross Reference

None

Program 50 : Common Channel Interoffice Signaling Service

50-04 : CCIS Office Code Assignment

Level:
IN

Description

Use **Program 50-04 : CCIS Office Code Assignment** to define the Office Code when the CCIS Network is constructed with an Open Numbering Plan.

Input Data

Item No.	Item	Input Data	Default
01	CCIS Office Code	xxxx (up to four digits) 0~9	No Setting

Conditions

- This program is used only in an Open Numbering Plan network. This should include the Trunk Access Code and Office Code number.

Feature Cross Reference

None

Program 50 : Common Channel Interoffice Signaling Service

50-05 : CCIS Maximum Call Forwarding Hop Counter

Level:
IN

Description

Use **Program 50-05 : CCIS Maximum Call Forwarding Hop Counter** to define the maximum hop counter of call forwarding.

Input Data

Item	Input Data	Default
Maximum Hop Counter	1~7	5

Conditions

None

Feature Cross Reference

None

Program 50 : Common Channel Interoffice Signaling Service

50-06 : CCIS Feature Availability

Level:
IN

Description

Use **Program 50-06 : CCIS Feature Availability** to define the availability of CCIS features.

Input Data

Item No.	Item	Input Data	Default	Description
01	Link Reconnect	0 = Not available 1 = Available	1	If this data is set to 0, Link Reconnect does not run.
02	Centralized Day/Night Switching (for message receiver side)	0 = Disable 1 = Enable	1	If this data is turned to 0, Day/Night mode is not changed even if system receives Switching message from center.

Conditions

None

Feature Cross Reference

None

Program 50 : Common Channel Interoffice Signaling Service

50-07 : CCIS Centralized Billing Center Office

Level:
IN

Description

Use **Program 50-07 : CCIS Centralized Billing Center Office** to define the Point Code and CCIS Route ID for the Billing Center Office.

Input Data

Item No.	Item	Input Data	Default	Description
01	Destination Point Code	0~16367	0	Define the Point Code of Billing Center Office.
02	CCIS Route ID	0~8	0	Define the CCIS Route ID to send Billing Center Office.
03	Billing Message Format	0 = Normal Format 1 = Expand Format	0	

Conditions

None

Feature Cross Reference

None

Program 50 : Common Channel Interoffice Signaling Service

50-08 : CCIS Centralized BLF Sending Group Assignment

Level:
IN

Description

Use **Program 50-08 : CCIS Centralized BLF Sending Group Assignment** to define the destination of BLF for the sending system. Eight sending systems can be registered in this program.

Input Data

BLF Sending Group	1~8
-------------------	-----

Item No.	Item	Input Data	Default	Description
01	Destination Point Code	0~16367	0	Define the Point Code of Billing Center Office.
02	CCIS Route ID	0~8	0	Define the CCIS Route ID to send Billing Center Office.

Conditions

None

Feature Cross Reference

None

Program 50 : Common Channel Interoffice Signaling Service

50-09 : CCIS Centralized BLF Sending Extension Number Assignment

Level:
IN

Description

Use **Program 50-09 : CCIS Centralized BLF Sending Extension Number Assignment** to define the extension number for sending BLF messages. One extension number can have a sending switch for each sending group, which is defined in Program 50-08.

Input Data

Entry	1~120
-------	-------

Item No.	Item	Input Data	Default	Description
01	Extension Number	xxxxxxx (up to eight digits)	No Setting	Extension number. BLF message is indicated when the status of the specified extension number is changed.
02	Send to Sending Group 1	0 = Disable 1 = Enable	0	Enable/Disable the ability to send the BLF to Send Group 1 assigned in PRG 50-08-XX.
03	Send to Sending Group 2	0 = Disable 1 = Enable	0	Enable/Disable the ability to send the BLF to Send Group 2 assigned in PRG 50-08-XX.
04	Send to Sending Group 3	0 = Disable 1 = Enable	0	Enable/Disable the ability to send the BLF to Send Group 3 assigned in PRG 50-08-XX.
05	Send to Sending Group 4	0 = Disable 1 = Enable	0	Enable/Disable the ability to send the BLF to Send Group 4 assigned in PRG 50-08-XX.
06	Send to Sending Group 5	0 = Disable 1 = Enable	0	Enable/Disable the ability to send the BLF to Send Group 5 assigned in PRG 50-08-XX.

Item No.	Item	Input Data	Default	Description
07	Send to Sending Group 6	0 = Disable 1 = Enable	0	Enable/Disable the ability to send the BLF to Send Group 6 assigned in PRG 50-08-XX.
08	Send to Sending Group 7	0 = Disable 1 = Enable	0	Enable/Disable the ability to send the BLF to Send Group 7 assigned in PRG 50-08-XX.
09	Send to Sending Group 8	0 = Disable 1 = Enable	0	Enable/Disable the ability to send the BLF to Send Group 8 assigned in PRG 50-08-XX.

Conditions

None

Feature Cross Reference

None

Program 50 : Common Channel Interoffice Signaling Service

50-10 : CCIS Centralized BLF Interval Time Assignment

Level:
IN

Description

Use **Program 50-10 : CCIS Centralized BLF Interval Time Assignment** to define the time to send BLF messages.

Input Data

Item No.	Item	Input Data	Default
01	Type of Interval Time Define the time to send BLF messages.	0 = 4 seconds 1 = 8 seconds 2 = 12 seconds 3 = 16 seconds	0

Conditions

None

Feature Cross Reference

None

Program 50 : Common Channel Interoffice Signaling Service

50-11 : CCIS Centralized Day/Night Switching Sending Group Assignment

Level:

IN

Description

Use **Program 50-11 : CCIS Centralized Day/Night Switching Sending Group Assignment** to define Point Code and CCIS Route ID for sending Day/Night Switching message.

Input Data

Day/Night Mode Sending Group	1~16
------------------------------	------

Input Data

Item No.	Item	Input Data	Default	Description
01	Destination Point Code	0~16367	0	Define the Point Code for Day/Night Switching.
02	CCIS Route ID	0~8	0	Define the CCIS Route ID to send Day/ Night Switching messages. (T1 only)

Conditions

None

Feature Cross Reference

None

Program 50 : Common Channel Interoffice Signaling Service

50-12 : CCIS Centralized Day/Night Mode to System Mode Assignment

Level:**IN**

Description

Use **Program 50-12 : CCIS Centralized Day/Night Mode to System Mode Assignment** to define corresponding night mode to switch to when Day/Night mode switching message arrives.

Input Data

Item No.	Item	Input Data	Default
01	Day Mode	1~8	1
02	Night Mode	1~8	2

Conditions

None

Feature Cross Reference

None

Program 50 : Common Channel Interoffice Signaling Service

50-13 : CCIS Centralized Response Timeout Assignment

Level:
IN

Description

Use **Program 50-13 : CCIS Centralized Response Timeout Assignment** to define the response timeout value.

Input Data

Item No.	Item	Input Data	Default
01	IAI Response Timer	0~99	30

Conditions

None

Feature Cross Reference

None

Program 50 : Common Channel Interoffice Signaling Service

50-14 : CCIS Intercom Digits for Caller ID Call Return

Level:
IN

Description

Use **Program 50-14 : CCIS Intercom Digits for Caller ID Call Return** to eliminate the 9 on Caller ID redial except for 7- and 8-digit extensions.

Input Data

Item No.	Item	Input Data	Default
01	CCIS Intercom Digits for Caller ID Call Return	0~24 (0 = Ignore setting)	0

Conditions

None

Feature Cross Reference

None

Program 50 : Common Channel Interoffice Signaling Service

50-15 : CCIS over IP Basic Information Setting

Level:
IN

Description

Use **Program 50-15 : CCIS over IP Basic Information Setting** to set the basic parameters for CCIS over IP.

Input Data

Item No.	Item	Input Data	Default
01	Connection Method	0 = Peer to Peer disable 1 = Peer to Peer enable	1
02	TCP Server Port Number	0~65535	57000
03	TCP Client Base Port Number	0~65535	59000
04	Connection Method for Terminal Choose the connection method for the DT700	0 = Peer to Peer disable 1 = Peer to Peer enable	1

Conditions

None

Feature Cross Reference

None

THIS PAGE INTENTIONALLY LEFT BLANK

Program 51 : NetLink Service



51-01 : NetLink System Property Setting

Level:
IN

Program
51

Description

Use **Program 51-01 : NetLink System Property Setting** to define the parameters of the NetLink feature.

-  **Each system must be set with its own information.**
-  **When the NetLink System ID is changed (Item 01), the system must be reset.**

Input Data

Item No.	Item	Input Data	Default
01	NetLink System ID This is the ID of each NetLink system. Setting should insure that no overlap occurs between nodes.	0~50 (0 = No operation)	0
02	Primary Candidate Order When the Primary system is turned off or disconnected from network, this value is used to select a new Primary system. Smaller number is higher priority. If this value is the same number, the System ID (PRG51-01-01) is referred, and the system which has the smaller number is selected as Primary system.	1~50	30
03	Secondary System Flag 0: NetLink is dynamically established based on Node List in PRG51-03-01. Primary System is selected in the order which the system wakes up. 1: The system connects with Top Priority Primary System. If Top Priority Primary System was not found, the system searches Primary System like this setting is 0.	0 = Disable 1 = Enable	0

Conditions

None

Feature Cross Reference

None

Program 51 : NetLink Service

51-02 : NetLink System Individual Setting

Level:
IN

Description

Use **Program 51-02 : NetLink System Individual Setting** to set system data for each NetLink system.

 **Program 51-02-03 is not used in US, but is used in other countries.**

Input Data

System ID	1~50
-----------	------

Item No.	Item	Input Data	Default
01	System Name Enter the name given to each system.	Up to 20 characters.	blank
02	Time Zone (Hour) Determine the time offset from the Primary system. (0 = -12, 1 = -11, 2 = -10.... 12 = 0 13 = +1, 14 = +2, 24 = +12) This setting affects Time Display on MLT (see 51-13-02).	0~24	12
03	--- Not Used ---		
04	Authenticate System MAC Address To use this function, set PRG 51-13-03 to 1 (enable), NetLink systems reject the connection from unauthenticated system access.	00-00-00-00-00-00~ FF-FF-FF-FF-FF-FF	00-00-00-00-00-00

Conditions

None

Feature Cross Reference

None

Program 51 : NetLink Service

51-03 : NetLink Internet Protocol Address List Setting

Level:
IN

Description

Use **Program 51-03 : NetLink Internet Protocol Address List Setting** to set the IP address of the NetLink system.

Input Data

List ID	1~50
---------	------

Item No.	Item	Input Data	Default
01	<p>Internet Protocol Address List</p> <p>The system seeks the Primary system based on this list.</p> <p>When there is no Primary system yet, or Fail-Over occurs, Node List is referred to establish new link. This setting is necessary when PRG 51-01-03 is 0, or PRG 51-05-02 is other than 0.</p> <p>Once the system connects to the Primary System, this setting is updated by the Primary system when PRG 51-13-01 is On. So, enter IP address of the systems that may become Primary at least.</p>	<p>0.0.0.0 ~ 126.255.255.254</p> <p>128.0.0.1 ~ 191.255.255.254</p> <p>192.0.0.1 ~ 223.255.255.254</p>	0.0.0.0

Conditions

- When there is no Primary System yet, or Fail Over occurs, Node List is referred to establish new link.
- This setting is necessary when PRG 51-01-03 is 0, or PRG 51-05-02 is other than 0. Once the system connects to the Primary System, this setting is updated by the Primary system when PRG 51-13-01 is on. So, enter IP address of the systems that may become Primary at least.

Feature Cross Reference

None

Program 51 : NetLink Service

51-04 : IP Address Setting of Top Priority Primary System of NetLink

Level:

IN

Description

Use **Program 51-04 : IP Address Setting of Top Priority Primary System of NetLink** to set the IP address of the new Primary System.

Input Data

List ID	1~50
---------	------

Item No.	Item	Input Data	Default
01	Internet Protocol Address of Top Priority Primary Enter the IP address of the Top Priority Primary System. To use this feature, set PRG 51-06-01 to 1.	0.0.0.0 ~ 126.255.255.254 128.0.0.1 ~ 191.255.255.254 192.0.0.1 ~ 223.255.255.254	0.0.0.0

Conditions

None

Feature Cross Reference

None

Program 51 : NetLink Service

51-05 : NetLink Timer Settings

Level:
IN

Description

Use **Program 51-05 : NetLink Timer Settings** to set the various timers in the NetLink system.

Item No.	Item	Input Data	Default
01	Keep Alive Sending Interval Set the Keep Alive sending interval time from the Secondary system to confirm communication with the Primary system.	1~3600 (sec)	5
02	Keep Alive Response Waiting Time Set the time the Secondary system waits for a response from the Primary system before cutting off communication.	0, 5~10800 (sec) (0 = infinity)	20
03	Primary Search Packet Sending Interval While searching the Primary system, the system sends a packet at this interval.	1~3600 (sec)	5
04	Primary Search Time Maximum Value Total Primary system seek time.	5~10800 (sec)	20
05	Top Priority Primary Detection Packet Sending Interval When current Primary system is not Top Priority Primary System, the system sends packet to check if Top Priority System exists.	1~3600 (sec)	10
06	Primary Compulsion Specification Trial Maximum Time When the forced change Primary command is executed, the system searches the new Primary system for this time.	1~10800 (sec)	30
07	Socket Refresh Time If the IP connection becomes unstable, the keep-alive function does not work. If there is no data traffic for this time, the socket is refreshed.	20~3600 (sec)	40

Conditions

None

Feature Cross Reference

None

Program 51 : NetLink Service

51-06 : NetLink Primary Automatic Integration Setting

Level:

IN

Description

Use **Program 51-06 : NetLink Primary Automatic Integration Setting** to set the automatic integration of the Primary system.

Input Data

Item No.	Item	Input Data	Default
01	Primary Integration Right or Wrong When LAN cable was divided, multiple Primary systems may appear. If the LAN connection is recovered, multiple Net-Links exist in the network. When this option is enabling, NetLink is composed around Top priority Primary System.	0 = Off 1 = On	0
02	Package Reset Timing Option When Primary System Automatic Integration is done, all packages of secondary systems reset. Select the timing of package reset.	0 = Reset when all packages are idle. 1 = Anytime	0

Conditions

None

Feature Cross Reference

None

Program 51 : NetLink Service

51-07 : NetLink Primary Compulsion Specification Setting

Level:
IN

Description

Use **Program 51-07 : NetLink Primary Compulsion Specification Setting** to set compulsion specification of the Primary system.

Input Data

Item No.	Item	Input Data	Default
01	Forced Change Primary System Enabling Set whether or not the Forced Change Primary is available.	0 = Disable 1 = Enable	1
02	Package Reset Timing Option When Forced Change Primary System is done, all packages reset. Select the package reset timing. 0 = Reset when all packages are idle, otherwise reject Primary System Integration. 1 = Anytime	0 = On 1 = Off	0

Conditions

None

Feature Cross Reference

None

Program 51 : NetLink Service

51-08 : Primary NetLink Setting

Level:
IN

Description

Use **Program 51-08 : Primary NetLink Setting** to set the IP address and system ID of the compulsory specification of the Primary system.

(This program is available only via telephone programming and not through PC Programming).

Input Data

Item No.	Item	Input Data	Default
01	IP Address of New Primary System Enter target IP address for New Primary system. When the Forced Change Primary system is done, this setting is erased.	0.0.0.0 ~ 126.255.255.254 128.0.0.1 ~ 191.255.255.254 192.0.0.1 ~ 223.255.255.254	0.0.0.0
02	System ID of New Primary System When set to 0, top priority Primary system is assumed to be the new Primary system.	0~50	No setting

Conditions

None

Feature Cross Reference

None

Program 51 : NetLink Service

51-09 : NetLink Communication Port Settings

Level:
IN

Description

Use **Program 51-09 : NetLink Communication Port Settings** to set the various communication ports used on the system.

Input Data

Item No.	Item	Input Data	Default
01	Primary Waiting Port Set the communication port that the Primary system uses to communicate with the Secondary system.	0~65535	58000
02	Communication Waiting Port Select port used to communicate between nodes. It is always opened by all nodes.	0~65535	58001
03	Secondary Communication Port Secondary system communicates with Primary system at this port number. If 0 is specified, temporary port is dynamically selected.	0~65535	0
04	Primary Search Port When Fail-Over occurs, each system communicates with other system at this port number. If 0 is set, temporary port is dynamically selected. If 0 is not specified, the number and continuous maximum 50 number is used. (Ex. 5000 is specified 5001, 5002...5049 are used).	0~65535	0
05	Primary Detection Port Enter port number to seek the Top Priority Primary system. If 0 is specified, temporary port is dynamically selected.	0~65535	0
06	Database Replication Communication Listening Port Use this port to replicate database.	0~65535	58002

Input Data

Item No.	Item	Input Data	Default
07	Database Replication Primary Detection Port Use Use this port to replicate database. If 0 is specified, temporary port is dynamically selected.	0~65535	0

Conditions

None

Feature Cross Reference

None

Program 51 : NetLink Service

51-10 : Virtual Slot Setting

Level:
IN

Description

Use **Program 51-10: Virtual Slot Setting** to view the number of Virtual slots that are remaining in a NetLink network. There can be up to 240 virtual slots available in NetLink.

Input Data

Item No.	Item	Input Data	Default
01	Number of Available Virtual Slots 240 slots can be controlled in NetLink. This command can check how many slots are available.		

Conditions

- This Program is Read Only.

Feature Cross Reference

None

Program 51 : NetLink Service

51-11 : NetLink System Information

Level:
IN

Description

Use **Program 51-11: NetLink System Information** to reference information about other systems in the NetLink network.

Input Data

System ID	1~50
-----------	------

Item No.	Item	Input Data	Default
01	System Name	For reference only.	blank
02	Connected State	For reference only.	0
03	IP Address	For reference only.	000.000.000.000
04	MAC Address	For reference only.	00:00:00:00:00:00
05	Primary Priority Level	For reference only.	0
06	Main Software Version	For reference only.	XX.XX

Conditions

- This Program is Read Only.

Feature Cross Reference

None

Program 51 : NetLink Service

51-12 : Primary System Information

Level:
IN

Description

Use **Program 51-12: Primary System Information** to reference information about the Primary System in the NetLink network.

Input Data

Item No.	Item	Input Data	Default
01	System ID	For reference only.	0
02	System Name	For reference only.	blank
03	IP Address	For reference only.	000.000.000.000
04	MAC Address	For reference only.	00:00:00:00:00:00
05	Primary Priority Level	For reference only.	0
06	Main Software Version	For reference only.	XX.XX

Conditions

- This Program is Read Only.

Feature Cross Reference

None

Program 51 : NetLink Service

51-13 : NetLink Options

Level:
IN

Description

Use **Program 51-13: NetLink Options** to enable automatic IP address List Operation updates, time zone information, and MAC address authorization.

Input Data

Item No.	Item	Input Data	Default
01	Automatic IP Address List Operation Update When set to 1, the list in PRG51-03-01 is automatically updated.	0 = Disable (Off) 1 = Enable (On)	1
02	Time Zone Option When set to 0, the following features are affected: Clock Display, Incoming/Outgoing History List. When set to 1, the following features are affected: VRS Time Announce, Date and Time Setting Service Code, Alarm Clock setting, and Hotel mode wake-up call.	0 = Disable (Off) 1 = Enable (On)	0
03	MAC Address Authorization Enable Refers to PRG 51-02-04 for setting MAC address.	0 = Disable (Off) 1 = Enable (On)	0

Conditions

None

Feature Cross Reference

None

Program 51 : NetLink Service

51-14 : NetLink System Control

Level:
IN

Description

Use **Program 51-14: NetLink System Control** to delete system and slot information.

(This program is available only via telephone programming and not through PC Programming).

Input Data

System ID	1~50
-----------	------

Menu Number	1 = System information deletion
-------------	---------------------------------

Item No.	Item	Input Data	Default
01	Delete System Information Delete system information and the slot information. The system must be disconnected.	1~50	1

Conditions

None

Feature Cross Reference

None

Program 51 : NetLink Service 51-15 : Demonstration Setting

Level:
IN

Description

Use **Program 51-15: Demonstration Setting** to automatically set the minimum setting values in NetLink. A system reset occurs after this command is executed.

(This program is available only via telephone programming and not through PC Programming).

Input Data

Menu Number	1 = Primary automatic setting 2 = Secondary 1 - automatic operation setting 3 = Secondary 2 - automatic operation setting 4 = Secondary 3 - automatic operation setting
-------------	--

Conditions

None

Feature Cross Reference

None

Program 51 : NetLink Service

51-16 : NetLink System Data Replication Mode Setting

Level:
IN

Description

Use **Program 51-16: NetLink System Data Replication Mode Setting** to set the system data replication between the Primary and Secondary systems.

Input Data

Item No.	Item	Input Data	Default
01	System Data Replication Mode Set the synchronous mode of the system data. When set to 1, the systems are synchronized at the time set in Item 02 below. When set to 2, the systems are synchronized at regular time intervals set in Item 03 below.	0 = Disable 1 = Setting Time Mode 2 = Interval Mode	1
02	System Data Replication Time Setting Set the time of day that both systems synchronize database (when Item 01 is set to 1.)	0000~2359	0200
03	System Data Replication Interval Setting Set the time interval that both systems synchronize database (when Item 01 is set to 2).	15~1440 (minutes)	30 (min)
04	Replication Time Stamp Show next replication time. (Read-Only)	Month: 0~12	–
		Day: 0~31	–
		Hour: 00~23	–
		Minute: 00~59	–
05	System Data Replication Wait Time Set the wait time until replication starts when NetLink is created.	1~86400 (seconds)	180 sec
06	System Data Replication Interval Set the time to start replication to the next node after replication to one node is completed.	0~86400 (seconds)	1 sec

Conditions

None

Feature Cross Reference

None

THIS PAGE INTENTIONALLY LEFT BLANK

Program 80 : Basic Hardware Setup for System

80-01 : Service Tone Setup

Level:
IN

Description

Use **Program 80-01 : Service Tone Setup** to define up to 64 Service Tones. Each service tone is defined by the combination of 32 Basic Tones.

Input Data

Service Tone Number	01~64
---------------------	-------

Item No.	Item	Input Data
01	Repeat Count	0~255 (0 = until On-Hook)

Unit Number	1~8
-------------	-----

Item No.	Item	Input Data
02	Basic Tone Number	1~33 (0 = No Tone) (33 = Default Time Slot)
03	Duration Count	1~255 (100~25500ms)
04	Gain Level (dB)	1~63 (-15.5 ~ +15.5)

Program

80

Table 2-15 Basic Tones

Basic Tone No.	Frequency (Hz)	Level (dB)	Basic Tone No.	Frequency (Hz)	Level (dB)
01	400	-13	17	520 / 650	-13 / -19
02	520	-13	18	650 / 780	-13 / -19
03	580	-13	19	780 / 1040	-13 / -19
04	660	-13	20	1040	-13
05	700	-13	21	450	-13
06	800	-13	22	950	-13
07	880	-13	23	1080	-13
08	1050	-13	24	400/450	-13/-13
09	350 / 440	-16 / -16	25	-- Reserve --	-
10	440 / 480	-16 / -16	26	-- Reserve --	-
11	480 / 620	-21 / -21	27	-- Reserve --	-
12	440	-16	28	-- Reserve --	-
13	-- Reserve --	-	29	-- Reserve --	-
14	520 / 650	-19 / -13	30	-- Reserve --	-
15	650 / 780	-19 / -13	31	-- Reserve --	-
16	780 / 1040	-19 / -13	32	-- Reserve --	-

Default

Service Tone No.	Service Tone	Repeat Count	Unit Count	Basic Tone No.	Duration	Gain Level (dB)
1	No Tone	0	Basic 1	0	10	32 (0dB)
2	Internal Dial Tone	0	Basic 1	9	10	32 (0dB)
3	Stutter Dial Tone	0	Basic 6	0 9 0 9 0 9	2 1 1 1 1 77	32 (0dB)
4	Internal Recall Dial Tone	2	Basic 2	9 0	1 1	32 (0dB) 32 (0dB)
5	Trunk Dial Tone	0	Basic 1	9	10	32 (0dB)

Service Tone No.	Service Tone	Repeat Count	Unit Count	Basic Tone No.	Duration	Gain Level (dB)
6	Internal Busy Tone	0	Basic 2	0 11	5 5	20 (-6dB) 20 (-6dB)
7	DND Busy Tone	0	Basic 2	0 1	2 2	32 (0dB) 32 (0dB)
8	B-Busy Tone	0	Basic 2	0 11	5 5	20 (-6dB) 20 (-6dB)
9	Internal Reorder Tone	0	Basic 2	11 0	3 2	20 (-6dB) 20 (-6dB)
10	Internal Interrupt Tone	0	Basic 2	0 1	1 1	32 (0dB) 32 (0dB)
11	Internal Confirmation Tone	3	Basic 2	0 6	5 1	32 (0dB) 32 (0dB)
12	Internal Hold Tone	0	Basic 0	0	0	32 (0dB)
13	External Hold Tone	0	Basic 0	0	0	32 (0dB)
14	Intercom Ringback Tone	0	Basic 2	9 0	10 20	32 (0dB) 32 (0dB)
15	Override Tone	1	Basic 1	12	5	32 (0dB)
16	Lock-out Tone	0	Basic 2	0 6	1 1	32 (0dB) 32 (0dB)
17	Clock Alarm Tone	0	Basic 4	6 0 6 0	1 1 1 7	32 (0dB) 32 (0dB) 32 (0dB) 32 (0dB)
18	BGM	0	Basic 0	0	0	32 (0dB)
19	Door Box Chime 1	3	Basic 6	4 4 2 2 2 0	2 2 3 4 6 5	38 (+3dB) 26 (-3dB) 38 (+3dB) 26 (-3dB) 14 (-9dB) 32 (0dB)
20	Door Box Chime 2	3	Basic 6	7 7 5 5 5 0	2 2 3 4 6 5	38 (+3dB) 26 (-3dB) 38 (+3dB) 26 (-3dB) 14 (-9dB) 32 (0dB)
21	Door Box Chime 3	3	Basic 6	8 8 6 6 6 0	2 2 3 4 6 5	38 (+3dB) 26 (-3dB) 38 (+3dB) 26 (-3dB) 14 (-9dB) 32 (0dB)

Service Tone No.	Service Tone	Repeat Count	Unit Count	Basic Tone No.	Duration	Gain Level (dB)
22	Door Box Chime 4	3	Basic 6	4	1	38 (+3dB)
				4	1	26 (-3dB)
				2	2	38 (+3dB)
				2	2	26 (-3dB)
				2	3	14 (-9dB)
				0	2	32 (0dB)
23	Door Box Chime 5	3	Basic 6	7	1	38 (+3dB)
				7	1	26 (-3dB)
				5	2	38 (+3dB)
				5	2	26 (-3dB)
				5	3	14 (-9dB)
				0	2	32 (0dB)
24	Door Box Chime 6	3	Basic 6	8	1	38 (+3dB)
				8	1	26 (-3dB)
				6	2	38 (+3dB)
				6	2	26 (-3dB)
				6	3	14 (-9dB)
				0	2	32 (0dB)
25	Service Set Tone	3	Basic 2	0	1	32 (0dB)
				9	1	32 (0dB)
26	Service Clear Tone	3	Basic 2	0	1	32 (0dB)
				9	1	32 (0dB)
27	Talkback Tone	2	Basic 2	0	1	32 (0dB)
				6	1	32 (0dB)
28	Speaker Monitor Tone The originator hears this tone when placing a handsfree speaker ICM call.	1	Basic 2	0	1	32 (0dB)
				6	1	32 (0dB)
29	Door Relay Tone	1	Basic 2	0	1	32 (0dB)
				6	1	32 (0dB)
30	Door Box Call Tone	1	Basic 2	0	1	32 (0dB)
				6	1	32 (0dB)
31	Paging Tone	2	Basic 2	0	1	32 (0dB)
				6	1	32 (0dB)
32	Splash Tone 1	1	Basic 2	0	1	32 (0dB)
				6	1	32 (0dB)
33	Splash Tone 2	2	Basic 2	0	1	32 (0dB)
				6	1	32 (0dB)
34	Splash Tone 3	3	Basic 2	0	1	32 (0dB)
				6	1	32 (0dB)
35	1-Second Signal Tone	1	Basic 1	6	10	32 (0dB)
36	External Audible Ring Tone	0	Basic 2	7	2	32 (0dB)
				0	2	32 (0dB)

Service Tone No.	Service Tone	Repeat Count	Unit Count	Basic Tone No.	Duration	Gain Level (dB)
37	External Reorder Tone	0	Basic 2	7 0	5 5	32 (0dB) 32 (0dB)
38	External Busy Tone	0	Basic 2	7 0	7 7	32 (0dB) 32 (0dB)
39	Special Audible Ring Busy Tone	0	Basic 6	0 11 0 11 10 0	5 5 5 5 10 20	32 (0dB) 32 (0dB) 32 (0dB) 32 (0dB) 32 (0dB) 32 (0dB)
40	Internal Call Waiting Tone	1	Basic 1	12	2	32 (0dB)
41	Intrusion Tone	1	Basic 1	12	5	32 (0dB)
42	Conference Tone	0	Basic 0	0	0	32 (0dB)
43	Intrusion Tone 2	0	Basic 1	2	8	32 (0dB)
44	External Dial Tone	0	Basic 1	9	1	26 (-3dB)
45	External Ring Back Tone	0	Basic 2	10 0	10 30	32 (0dB) 32 (0dB)
46	External Busy Tone	0	Basic 2	11 0	5 5	32 (0dB) 32 (0dB)
47	Number Unobtainable Tone	0	Basic 1	11	0	32 (0dB)
48	Voice Mail Message Indication Tone	0	Basic 2	9 0	1 1	32 (0dB) 32 (0dB)
49	--- Not Used ---					
50	External Special Audible Ring Tone	0	3	10 12 0	10 2 30	32 (0dB) 32 (0dB) 32 (0dB)
51	External Intercept Tone	0	2	12 4	3 2	32 (0dB) 32 (0dB)
52	External Call Waiting Tone	1	1	12	3	32 (0dB)
53	External Executive Override Tone	1	1	12	10	32 (0dB)
54	--- Not Used ---					
55	Generate tone for TAPI2.1	0	Basic 1	3	0	32 (0dB)
56	Warning Beep Tone Signaling	1	Basic 1	2	8	32 (0dB)
57	Headset Ear Piece Ringing Tone	0	Basic 5	0 2 0 2 0	2 1 1 1 20	32 (0dB) 32 (0dB) 32 (0dB) 32 (0dB) 32 (0dB)

Service Tone No.	Service Tone	Repeat Count	Unit Count	Basic Tone No.	Duration	Gain Level (dB)
58	Opening Chime Tone	1	Basic 8	2	2	32 (0dB)
				2	2	26 (-3dB)
				14	2	32 (0dB)
				14	2	26 (-3dB)
				15	2	32 (0dB)
				15	2	26 (-3dB)
				16	6	32 (0dB)
				16	4	26 (-3dB)
59	Ending Chime Tone	1	Basic 8	20	2	32 (0dB)
				20	2	26 (-3dB)
				19	2	32 (0dB)
				19	2	26 (-3dB)
				18	2	32 (0dB)
				18	2	26 (-3dB)
				17	6	32 (0dB)
				17	4	26 (-3dB)
60	Splash Tone 1 (Mute)	1	Basic 2	0	1	8 (-12dB)
				6	1	8 (-12dB)
61	Splash Tone 2 (Mute)	2	Basic 2	0	1	8 (-12dB)
				6	1	8 (-12dB)
62	Splash Tone 3 (Mute)	3	Basic 2	0	1	8 (-12dB)
				6	1	8 (-12dB)
63	EXT SPK Ring-back Tone	0	Basic 2	10	10	32 (0dB)
				0	30	32 (0dB)
64	Special Hold Tone	0	4	11	2	35 (+1.5dB)
				0	3	32 (0dB)
				11	2	35 (+1.5dB)
				0	12	32 (0dB)

Conditions

- The system must be reset for any change to these items to take affect.

Feature Cross Reference

- Selectable Ring Tones

Program 80 : Basic Hardware Setup for System

80-02 : DTMF Tone Setup

Level:
MF

Description

Use **Program 80-02 : DTMF Tone Setup** to define the duration (On time) and pause (Off time) for DTMF dialing. This option affects all trunk line calls system wide. Make separate entries for duration and pause. It is also possible to adjust the level of both high and low frequency tone.

Input Data

Item No.	Item	Input Data	Default
01	Duration	1~255	5 (100ms)
02	Pause	1~255	5 (100ms)
03	Tone Level (Low) (dB)	1~97 -45 : +3	65 (-13dB)
04	Tone Level (High)	1~97 -45 : +3	69 (-11dB)



Conditions

None

Feature Cross Reference

None

Program 80 : Basic Hardware Setup for System

80-03 : DTMF Tone Receiver Setup

Level:
MF

Description

Use **Program 80-03 : DTMF Tone Receiver Setup** to define the various levels and timers for the DTMF Tone Receiver.

DTMF Tone Receiver Type:

- 1 = DTMF Receiver for Extension
- 2 = DTMF Receiver for Analog Trunk
- 3 = DTMF Receiver for Digital Trunk
- 4, 5 = Reserved

Input Data

DTMF Tone Receiver Type No.	1 = DTMF Receiver for Extension 2 = DTMF Receiver for Analog Trunk 3 = DTMF Receiver for Digital Trunk 4 = --- Reserved --- 5 = --- Reserved ---
-----------------------------	--

Item No	Item	Input Data
01	Detect Level	0 = 0dBm ~ -25dBm 1 = -5dBm ~ -30dBm 2 = -10dBm ~ -35dBm 3 = -15dBm ~ -40dBm 4 = -20dBm ~ -45dBm 5 = -25dBm ~ -50dBm 6 = -30dBm ~ -55dBm
02	Start Delay Time	0~255 (0.25ms ~ 64ms)

Item No	Item	Input Data
03	Min. Detect Level	0~15 Detect Level 0 : -10dBm(0) to -25dBm(15) Detect Level 1 : -15dBm(0) to -30dBm(15) Detect Level 2 : -20dBm(0) to -35dBm(15) Detect Level 3 : -25dBm(0) to -40dBm(15) Detect Level 4 : -30dBm(0) to -45dBm(15) Detect Level 5 : -35dBm(0) to -50dBm(15) Detect Level 6 : -40dBm(0) to -55dBm(15) Detect Level 7 : -45dBm(0) to -60dBm(15) Detect Level 8 : -50dBm(0) to -65dBm(15) Detect Level 9 : -55dBm(0) to -70dBm(15) Detect Level 10 : -60dBm(0) to -75dBm(15) Detect Level 11 : -65dBm(0) to -80dBm(15) Detect Level 12 : -70dBm(0) to -85dBm(15) Detect Level 13 : -75dBm(0) to -90dBm(15) Detect Level 14 : -80dBm(0) to -95dBm(15) Detect Level 15 : -85dBm(0) to -100dBm(15)
04	Max. Detect Level	0~15 Detect Level 0 : 0dBm(0) to -15dBm(15) Detect Level 1 : -5dBm(0) to -20dBm(15) Detect Level 2 : -10dBm(0) to -25dBm(15) Detect Level 3 : -15dBm(0) to -30dBm(15) Detect Level 4 : -20dBm(0) to -35dBm(15) Detect Level 5 : -25dBm(0) to -40dBm(15) Detect Level 6 : -30dBm(0) to -45dBm(15) Detect Level 7 : -35dBm(0) to -50dBm(15) Detect Level 8 : -40dBm(0) to -55dBm(15) Detect Level 9 : -45dBm(0) to -60dBm(15) Detect Level 10 : -50dBm(0) to -65dBm(15) Detect Level 11 : -55dBm(0) to -70dBm(15) Detect Level 12 : -60dBm(0) to -75dBm(15) Detect Level 13 : -65dBm(0) to -80dBm(15) Detect Level 14 : -70dBm(0) to -85dBm(15) Detect Level 15 : -75dBm(0) to -90dBm(15)
05	Forward Twist Level	0~9 (1dB ~ 10dB)
06	Backward Twist Level	0~9 (1dB ~ 10dB)
07	ON Detect Time	1~255 (15+ 15ms ~ 3825ms)
08	OFF Detect Time	1-255 (15+ 15ms ~ 3825ms)

Default

Item No	Item	Type 1	Type 2	Type 3	Type 4	Type 5
01	Detect Level	0	0	0	0	0
02	Start delay time	0	0	0	0	0
03	Min. detect level	10 (-20dBm)	15 (-25dBm)	15 (-25dBm)	10 (-20dBm)	10 (-20dBm)
04	Max. detect level	2 (-2dBm)	2 (-2dBm)	2 (-2dBm)	2 (-2dBm)	2 (-2dBm)
05	Forward twist level	5 (6dBm)	5 (6dBm)	5 (6dBm)	5 (6dBm)	5 (6dBm)
06	Backward twist level	0 (1dBm)	0 (1dBm)	0 (1dBm)	0 (1dBm)	0 (1dBm)
07	ON detect time	1 (30ms)	1 (30ms)	1 (30ms)	1 (30ms)	1 (30ms)
08	OFF detect time	1 (30ms)	1 (30ms)	1 (30ms)	1 (30ms)	1 (30ms)

Conditions

None

Feature Cross Reference

None

Program 80 : Basic Hardware Setup for System

80-04 : Call Progress Tone Detector Setup

Level:
MF

Description

Use **Program 80-04 : Call Progress Tone Detector Setup** to define the various levels and timers for the Call Progress Tone Detector.

Tone Detector Type:

- 1 = Dial Tone for Trunk
- 2 = Busy Tone for Trunk
- 3 = Ring Back Tone for Trunk
- 4, 5 = Reserved

Input Data

Tone Detector Type Number	1 = Dial Tone for Trunk 2 = Busy Tone for Trunk 3 = Ring Back Tone for Trunk 4 = --- Reserved --- 5 = --- Reserved ---
---------------------------	--

Item No	Item	Input Data
01	Detection Level	0 = 0dBm ~ -25dBm 1 = -5dBm ~ -30dBm 2 = -10dBm ~ -35dBm 3 = -15dBm ~ -40dBm 4 = -20dBm ~ -45dBm 5 = -25dBm ~ -50dBm 6 = -30dBm ~ -55dBm
02	Min. Detection Level	0~15 0 = -10dBm(0) to -25dBm(15) 1 = -15dBm(0) to -30dBm(15) 2 = -20dBm(0) to -35dBm(15) 3 = -25dBm(0) to -40dBm(15) 4 = -30dBm(0) to -45dBm(15) 5 = -35dBm(0) to -50dBm(15) 6 = -40dBm(0) to -55dBm(15)
03	S/N Ratio	0~4 (0dB ~ -20dB)

Item No	Item	Input Data
04	No Tone Time	0~255 (30+30~7680ms) (0 = not detect) 1~255 = 60~7680ms. The formula is 30+30N. When set to N=1, it means 30+30*1=60 When set to N=255, it means 30+30*255=7680
05	Pulse Count	1~255
06	ON Minimum Time	1~255 (30+30~7680ms)
07	ON Maximum Time	0~255 (30+30~7680ms)
08	OFF Minimum Time	1~255 (30+30~7680ms)
09	OFF Maximum Time	0~255 (30+30~7680ms)
12	Frequency No. 1	1~8 (Frequency Table No. set by 80-07)
13	Frequency No. 2	1~8 (Frequency Table No. set by 80-07)

Default

Item	Name	Type 1 (DT)	Type 2 (BT)	Type 3 (RBT)	Type 4	Type 5
1	Detect Level	0 (-25dBm)	0 (-25dBm)	0 (-25dBm)	0	0
2	Min. detect level	15 (-25dBm)	15 (-25dBm)	15 (-25dBm)	0	0
3	S/N ratio	4 (-20dB)	4 (-20dB)	4 (-20dB)	0	0
4	No tone time	132 (3990ms)	132 (3990ms)	132 (3990ms)	0	0
5	Pulse Count	1	1	1	0	0
6	ON min. time	9 (300ms)	12(390ms)	25 (780ms)	0	0
7	ON max. time	0	20(630ms)	40 (1230ms)	0	0
8	OFF min. time	1 (60ms)	12(390ms)	83 (2520ms)	0	0
9	OFF max. time	1 (60ms)	20(630ms)	115 (3480ms)	0	0

Conditions

None

Feature Cross Reference

None

Program 80 : Basic Hardware Setup for System

80-05 : Date Format for SMDR and System

Level:**MF**

Description

Use **Program 80-05 : Date Format for SMDR and System** to define the date format when printing out the SMDR, alarm report, and system information report.

Input Data

Item No.	Item	Input Data	Default
01	Date Format	0 = American Format (Month / Day / Year) 1 = Japanese Format (Year / Month / Day) 2 = European Format (Day / Month / Year)	0

Conditions

None

Feature Cross Reference

None

Program 80 : Basic Hardware Setup for System

80-07 : Call Progress Tone Detector Frequency Setup

Level:
MF

Description

Use **Program 80-07 : Call Progress Tone Detector Frequency Setup** to set the frequency of the detection tone set with Program 80-04-12 and Program 80-04-13.

Input Data

Frequency Table No.	Input Data	Default
1	0, 10~255 (100~2550 Hz) (0 = Not used)	35 (350 Hz)
2		44 (440 Hz)
3		48 (480 Hz)
4		62 (620 Hz)
5		0
6		0
7		0
8		0

Conditions

None

Feature Cross Reference

None

Program 80 : Basic Hardware Setup for System

80-09 : Short Ring Setup

Level:
IN

Description

Use **Program 80-09 : Short Ring Setup** to define the short ring tone for SV8100 multiline terminals.

Input Data

Short Ring Number	01~32
-------------------	-------

Item No.	Item	Description	Default
01	Frequency 1	Refer to Table 2-16 Frequency 1/2 Table	00 = No Setting, 01~15
02	Frequency 2	Refer to Table 2-16 Frequency 1/2 Table	00 = No Setting, 01~15
03	Ring Cycle	Refer to Table 2-17 Ring Cycle Table	00 = No Setting, 01~14

 *When a single tone is sent, Frequency 1/2 is set to the same value.*

Table 2-16 Frequency 1/2 Table

Data	Frequency (Hz)
01	392
02	440
03	494
04	523
05	587
06	659
07	698
08	784
09	880
10	988
11	1046

Table 2-16 Frequency 1/2 Table (Continued)

Data	Frequency (Hz)
12	1175
13	1318
14	1397
15	1568

Table 2-17 Ring Cycle Table

Data	Ring Cycle (ms)
01	125(On)/Off
02	125(On)/125(Off)/125(On)/Off
03	125(On)/125(Off)/125(On)/125(Off)/125(On)/Off
04	125(On)/125(Off)/125(On)/125(Off)/125(On)/125(Off)/125(On)/Off
05	250(On)/Off
06	250(On)/250(Off)/250(On)/Off
07	250(On)/250(Off)/250(On)/250(Off)/250(On)/Off
08	250(On)/250(Off)/250(On)/250(Off)/250(On)/250(Off)/250(On)/Off
09	325(On)/Off
10	325(On)/325(Off)/325(On)/Off
11	325(On)/325(Off)/325(On)/325(Off)/325(On)/Off
12	500(On)/Off
13	500(On)/500(Off)/500(On)/Off
14	1000(On)/Off

Table 2-18 Default Table

Short Ring No.	Short Tone Name	Frequency 1	Frequency 2	Ring Cycle
1	Confirmation Tone	8	8	1
2	Error Tone	8	8	14
3	Alarm Tone for long conversation call	4	4	14
4	Not defined	0	0	0
:	:	:	:	:
32	Not defined	0	0	0

Conditions

None

Feature Cross Reference

None

Program 80 : Basic Hardware Setup for System

80-10 : MF Tone Receiver Setup

Level:

MF

Description

Use **Program 80-10 : MF Tone Receiver Setup** to various data for the MF signal detection.

Input Data

MF Tone Receiver Type Number	1 = MF Receiver for Extension 2 = MF Receiver for Trunk 3 = Reserved 4 = Reserved 5 = Reserved
------------------------------	--

Input Data

Item No.	Item	Input Data
01	Detect Level	0 = 0dBm ~ -25dBm 1 = -5dBm ~ -30dBm 2 = -10dBm ~ -35dBm 3 = -15dBm ~ -40dBm 4 = -20dBm ~ -45dBm 5 = -25dBm ~ -50dBm 6 = -30dBm ~ -55dBm
02	Start delay time	0~255 (0.25step, 0ms~64ms)
03	Min. detect level	0~15 MF Tone 1 : -15dBm(0) to -30dBm(15) MF Tone 2 : -20dBm(0) to -35dBm(15) MF Tone 3 : -25dBm(0) to -40dBm(15) MF Tone4 : -30dBm(0) to -45dBm(15) MF Tone 5 : -35dBm(0) to -50dBm(15)

Input Data

Item No.	Item	Input Data
04	Max. detect level	0~15 MF Tone 1 : -5dBm(0) to -20dBm(15) MF Tone 2 : -10dBm(0) to -25dBm(15) MF Tone 3 : -15dBm(0) to -30dBm(15) MF Tone 4 : -20dBm(0) to -35dBm(15) MF Tone 5 : -25dBm(0) to -40dBm(15) MF Tone 6 : -30dBm(0) to -45dBm(15)
05	Twist level	0~9 (1dB~10dB)
06	S/N ratio	0~4 (-5step, 0dB~ -20dB)
07	ON detect time	1~255 (15step, 30ms~3840ms)
08	OFF detect time	1~255 (15step, 30ms~3840ms)

Table 2-19 Default Table

Item	Name	Type 1	Type 2	Type 3	Type 4	Type 5
01	Detect Level	0	0	0	0	0
02	Start delay time	0	0	0	0	0
03	Min. detect level	10 (-20dBm)	10 (-20dBm)	10 (-20dBm)	10 (-20dBm)	10 (-20dBm)
04	Max. detect level	2 (-2dBm)	2 (-2dBm)	2 (-2dBm)	2 (-2dBm)	2 (-2dBm)
05	twist level	5 (6dBm)	5 (6dBm)	5 (6dBm)	5 (6dBm)	5 (6dBm)
06	S/N ratio	2 (-10dBm)	2 (-10dBm)	2 (-10dBm)	2 (-10dBm)	2 (-10dBm)
07	ON detect time	1 (30ms)	1 (30ms)	1 (30ms)	1 (30ms)	1 (30ms)
08	OFF detect time	1 (30ms)	1 (30ms)	1 (30ms)	1 (30ms)	1 (30ms)

Conditions

None

Feature Cross Reference

None

Program 81 : Basic Hardware Setup for Trunk

81-01 : COT Initial Data Setup

Level:
MF

Description

Use **Program 81-01 : COT Initial Data Setup** to define the various basic data parameters for the COT (CO blade) Unit.

Input Data

Item No.	Item	Input Data	Default
01	PCM Encoding Method Specification	0 = μ -law 1 = A-law	0
02	Loop Current Detection Time	1~255 (8~2040ms)	75 (600ms)
03	Clear Signal (Open Loop) Detection Time	1~255 (8~2040ms)	38 (304ms)
04	Ringling Signal Detection Minimum Time	1~255 (8~2040ms)	13 (104ms)
05	Single Ringing Detection Minimum Time	0~255 (0,8~2040ms)	82 (656ms)
06	Double Ringing Detection Minimum Off Time	0~255 (0,8~2040ms)	13 (104ms)
07	Double Ringing Detection Maximum Off Time	0~255 (0,8~2040ms)	50 (400ms)
08	Ringling Signal not Detection Minimum	1~255 (8~2040ms)	88 (704ms)
09	Time Ringing Signal Stop Detection Time	1~255 (64~16320ms)	94 (6016ms)
10	Continuous Ringing Minimum Time	0~255 (0,8~2040ms)	38 (304ms)
11	Continuous Ringing Maximum Time	0~255 (0,8~2040ms)	88 (704ms)
12	Caller ID Detection Time	0~255 (0~16320ms)	0 (0ms)

Program

81

Input Data

Item No.	Item	Input Data	Default
13	Grounding Time	1~255 (16~4080ms)	9 (144ms)
14	Hook Flash 1 Time	1~255 (16~4080ms)	50 (800ms)
15	Hook Flash 2 Time	1~255 (16~4080ms)	156 (2496ms)
16	Pause Time	1~255 (64~16320ms)	16 (1024ms)
17	PFT Idle Detection Time	1~255 (64~16320ms)	47 (3008ms)
18	Grounding Start Time	1~255 (8~2040ms)	6 (48ms)
19	Grounding Start Give Up Time	1~255 (64~16320ms)	47 (3008ms)
20	Loop Reverse Detect Minimum Time	1~255 (8~2040ms)	13 (104ms)
21	Loop Reverse Detect Maximum Time	1~255 (8~2040ms)	107 (856ms)
22	Loop Disconnect Detect Minimum Time	1~255 (8~2040ms)	50 (400ms)
23	Loop Disconnect Detect Maximum Time	1~255 (8~2040ms)	80 (640ms)
24	On Hook Normal Detect Time	1~255 (8~2040ms)	2 (24ms)
25	On Hook Reverse Detect Time	1~255 (8~2040ms)	2 (16ms)
26	On Hook Disconnect Detect Time	1~255 (16~4080ms)	188 (3008ms)
27	Dial Pulse Break Time (10pps)	1~255 (8~2040ms)	8 (64ms)
28	Dial Pulse Make Time (10pps)	1~255 (8~2040ms)	5 (40ms)
29	DP Inter-digit Time (10pps)	1~255 (32~8160ms)	25 (800ms)
30	Dial Pulse Break Time (20pps)	1~255 (8~2040ms)	4 (32ms)
31	Dial Pulse Make Time (20pps)	1~255 (8~2040ms)	2 (16ms)

Input Data

Item No.	Item	Input Data	Default
32	DP Inter-digit Time (20pps)	1~255 (32~8160ms)	16 (512ms)
33	--- Not Used ---		
34	--- Not Used ---		
35	--- Not Used ---		
36	Long Ringing Detection Minimum Time	1~255 (16~4080ms)	150 (2400ms)

Conditions

None

Feature Cross Reference

None

Program 81 : Basic Hardware Setup for Trunk

81-02 : DIOPU Initial Data Setup

Level:
MF

Description

Use **Program 81-02 : DIOPU Initial Data Setup** to define the various basic timers for the DID Unit.

Input Data

Item	Name	Input Data	Default
01	PCM Method Type	0 = μ -law 1 = A-law	0
02	Answer Signal Time	1~255 (10~2550ms)	6 (60ms)
03	Clear Signal (Open Loop) Detection Time	1~255 (100~25500ms)	7 (700ms)
04	Ringing Signal Detection Minimum Time	1~255 (10~2550ms)	10 (100ms)
05	Hook Flash Time	1~255 (8~2040ms)	25 (200ms)
06	Pause Time	1~255 (32~8160ms)	94 (3008ms)
07	WINK/DELAY Duration Time	1~255 (10~2550ms)	20 (200ms)
08	Incoming-WINK/DELAY Send Time	1~255 (100~25500ms)	3 (300ms)
09	Seizure-WINK/DELAY Receive Max. Time	1~255 (100~25500ms)	48 (4800ms)
10	Receive WINK/DELAY Duration Min. Time	1~255 (10~2550ms)	13 (130ms)
11	Receive WINK/DELAY Duration Max. Time	1~255 (10~2550ms)	31 (310ms)
12	Receive DP Make Minimum Time	1~255 (2~510ms)	5 (10ms)
13	Receive DP Make Maximum Time	1~255 (2~510ms)	50 (100ms)

Input Data

Item	Name	Input Data	Default
14	Receive DP Break Minimum Time	1~255 (2~510ms)	5 (10ms)
15	Receive DP Break Maximum Time	1~255 (2~510ms)	50 (100ms)
16	Receive DP Inter-Digit Time	1~255 (32~8160ms)	6 (192ms)
17	Loop Off Guard Time	0~25 (0,100~25500ms)	20 (2000ms)
18	DP Break Time (10pps)	1~255 (4~1020ms)	16 (64ms)
19	DP Make Time (10pps)	1~255 (4~1020ms)	8 (32ms)
20	DP Inter-Digit Time (10pps)	1~255 (16~4080ms)	38 (608ms)
21	DP Break Time (20pps)	1~255 (4~1020ms)	8 (32ms)
22	DP Make Time (20pps)	1~255 (4~1020ms)	4 (16ms)
23	DP Inter-Digit Time (20pps)	1~255 (16~4080ms)	29 (464ms)

Conditions

None

Feature Cross Reference

None

Program 81 : Basic Hardware Setup for Trunk

81-03 : ODT Initial Data Setup

Level:
IN

Description

Use **Program 81-03 : ODT Initial Data Setup** to define the various basic timers for the E&M Tie Line Unit.

Input Data

Item	Name	Input Data	Default
01	PCM Method Type	0 = μ -law 1= A-law	0
02	Answer Signal Time	1~255 (10~2550ms)	6 (60ms)
03	Clear Signal (Open Loop) Detection Time	1~255 (100~25500ms)	7 (700ms)
04	Ringing Signal Detection Minimum Time	1~255 (10~2550ms)	10 (100ms)
05	Ringing Signal Stop Detection Time	1~255 (100~25500ms)	7 (700ms)
06	Hook Flash Time	1~255 (10~2040ms)	20 (200ms)
07	Pause Time	1~255 (60~15300ms)	50 (3000ms)
08	WINK/DELAY Duration Time	1~255 (10~2550ms)	20 (200ms)
09	Incoming-WINK/DELAY Send Time	1~255 (100~25500ms)	3 (300ms)
10	Seizure-WINK/DELAY Receive Max. Time	1~255 (100~25500ms)	48 (4800ms)
11	Receive WINK/DELAY Duration Min. Time	1~255 (10~2550ms)	13 (130ms)
12	Receive WINK/DELAY Duration Max. Time	1~255 (10~2550ms)	31 (310ms)
13	Receive DP Make Minimum Time	1~255 (2~510ms)	5 (10ms)

Input Data

Item	Name	Input Data	Default
14	Receive DP Make Maximum Time	1~255 (2~510ms)	50 (100ms)
15	Receive DP Break Minimum Time	1~255 (2~510ms)	5 (10ms)
16	Receive DP Break Maximum Time	1~255 (2~510ms)	50 (100ms)
17	Pause Time after WINK/DELAY Receive	1~255 (8~2040ms)	13 (104ms)
18	Loop Off Guard Time	0~255 (0,100~25500ms)	20 (2000ms)
19	DP Break Time (10pps)	1~255 (2~512ms)	32 (64ms)
20	DP Make Time (10pps)	1~255 (2~512ms)	16 (32ms)
21	DP Inter-digit Time (10pps)	1~255 (32~8160ms)	19 (608ms)
22	DP Break Time (20pps)	1~255 (2~510ms)	16 (32ms)
23	DP Make Time (20pps)	1~255 (2~510ms)	8 (16ms)
24	DP Inter-digit Time (20pps)	1~255 (32~8160ms)	16 (512ms)

Conditions

None

Feature Cross Reference

None

Program 81 : Basic Hardware Setup for Trunk

81-04 : ISDN BRI Layer 1 (T-Point) Initial Data Setup

Level:
MF

Description

Use **Program 81-04 : ISDN BRI Layer 1 (T-Point) Initial Data Setup** to define the various basic data for layer 1 of ISDN BRI.

Input Data

Item No.	Item	Input Data	Default
01	Wait time for Physical Activation (Timer 3)	1~255 (200~5100ms)	100 (20sec)
02	Detection time for Physical Deactivation	1~255 (200~5100ms)	5 (1sec)

Conditions

None

Feature Cross Reference

None

Program 81 : Basic Hardware Setup for Trunk

81-05 : ISDN BRI & PRI Layer 2 (T-Point) Initial Data Setup

Level:
MF

Description

Use **Program 81-05 : ISDN BRI & PRI Layer 2 (T-Point) Initial Data Setup** to define the various basic data for layer 2 of ISDN BRI and PRI.

Input Data

Item No.	Item	Description	Input Data	Default
01	Timer T200	Specify the timer value in 1/100ths of a second at the end of which transmission of a frame may be initiated.	1~255 (100~25500ms)	10 (1sec)
02	Timer T201	Specify the minimum time in 1/100ths of a second between retransmissions of the TEI Identity check messages.	1~255 (100~25500ms)	10 (1sec)
03	Timer T202	Specify the minimum time in 1/100ths of a second between retransmissions of the TEI Identity check messages.	1~255 (100~25500ms)	20 (2sec)
04	Timer T203	Specify the maximum time in 1/100ths of a second allowed without exchanging frames.	1~255 (100~25500ms)	250 (25sec)
05	N200	Specify the retransmission count.	1~255	3
06	N201	Specify the frame lengths in ocelots.	1~65535 (Byte)	260
07	N202	Specify the maximum number of transmissions from a TEI identity request message when the user requests a TEI.	1~255	3

Conditions

None

Feature Cross Reference

None

Program 81 : Basic Hardware Setup for Trunk

81-06 : ISDN BRI & PRI Layer 3 (T-Point) Timer Setup

Level:
IN

Description

Use **Program 81-06 : ISDN BRI & PRI Layer 3 (T-Point) Timer Setup** to define the various basic timers for layer 3 of ISDN BRI/PRI (defined in Program 10-03-04).

Input Data

Layer 3 Timer Type Number	1~5
---------------------------	-----

Item No.	Item	Description	Input Data	Default
01	T301	Specify the timer value started when the ALERT message is received.	0,180~254 (sec)	180
02	T302	Specify the timer value started when the SETUP ACK is sent. Timer is also restarted when INFO is received.	1~254 (sec)	15
03	T303	Specify the timer value started when SETUP is sent.	1~254 (sec)	4
04	T304	Specify the timer value started when the SETUP ACK is received. Timer is also restarted when INFO is received.	0~254 (sec).	30
05	T305	Specify the timer value started when DISC without progress No. 8 is sent.	1~254 (sec)	30
06	T306	Specify the timer value started when DISC with progress indicator No. 8 is sent. This timer is valid for Network side use only.	0~254 (sec)	30
07	T307	Specify the timer value started when SUSPEND ACK is sent. This timer is valid for Network side use only.	1~254 (sec)	180
08	T308	Specifies the timer value started when REL is sent.	1~254 (sec)	4
09	T309	Specify the timer value started at data link disconnection.	1-254 (sec)	90
10	T310	Specify the timer value started when CALL PROC is sent.	0~180 (sec)	180
11	T312	Specify the timer value started when SETUP is sent or re-sent on broadcast data link. This timer is valid only for Network side use only.	1~254 (sec)	6

Item No.	Item	Description	Input Data	Default
12	T313	Specify the timer value started when connection request is sent. Valid range 1 ~ 4 seconds in 1 second increments. Value of 0 indicates timer not used.	1~254 (sec)	4
13	T314	Specify the timer value started when message segment is received.	1~254 (sec)	4
14	T316	Specify the timer value started when RESTART is sent.	(T317+1)~254 (sec)	120
15	T317	Specify the timer value started when RESTART is received.	1~(T316-1)	60
16	T318	Specify the timer value started when RES is sent. This timer is valid for user side use only.	1~254 (sec)	4
17	T319	Specify the timer value started when SUSPEND is sent. This timer is valid for user side use only.	1~254 (sec)	4
18	T320	Specify the timer value when B-channel access: connection is received, or D-channel access: DL-ESTABLISH confirmation or indication is received.	1~254 (sec)	30
19	T321	Specify the timer value started when STATUS ENQ is received.	1~254 (sec)	30
20	T322	Specify the timer value upon D-channel failure.	1~254 (sec)	4

Conditions

None

Feature Cross Reference

- ISDN Compatibility

Program 81 : Basic Hardware Setup for Trunk

81-07 : CODEC Filter Setup for Analog Trunk Port

Level:
IN

Description

Use **Program 81-07 : CODEC Filter Setup for Analog Trunk Port** to define the CODEC (QSLAC) Filter for each analog trunk port.

Input Data

Trunk Number	1~200
--------------	-------

CODEC Filter Type	Default
0 = No filter 1 = Type 1: 600 Ω Line loss 0dB (~500m from CO Ex) 2 = Type 2: 600 Ω Line loss 4dB (1~2km from CO Ex) 3 = Type 3: 600 Ω Line loss 8dB (~3km from CO Ex) 4 = Type 4: Enable PRG81-17 setting	2 (see Conditions below)

Conditions

- The adjustments of PRG 81-07 and 81-17 require CPU software 2.51 or higher.
- Version 2.51 or lower will have a default value of 1.
- Version 3.00 or higher will have a default value of 2.

Feature Cross Reference

None

Program 81 : Basic Hardware Setup for Trunk

81-08 : T1 Trunk Timer Setup

Level:
IN

Description

Use **Program 81-08 : T1 Trunk Timer Setup** to define the basic timer setting of each T1 Trunk type.

Item	Name	Input Data	Default
01	Answer Signal Detection Time (Loop)	1~250 (4ms ~ 1000ms)	15 60ms
02	Answer Signal Detection Time (Ground)	1~250 (4ms ~ 1000ms)	15 60ms
03	Answer Signal Detection Time (DID)	1~250 (4ms ~ 1000ms)	15 60ms
04	Answer Signal Detection Time (E&M)	1~250 (4ms ~ 1000ms)	15 60ms
05	Answer Signal Detection Time (OPX)	1~250 (4ms ~ 1000ms)	15 60ms
06	Clear Signal Detection Time (Loop)	1~255 (100ms ~ 25500ms)	6 600ms
07	Clear Signal Detection Time (Ground)	1~255 (100ms ~ 25500ms)	6 600ms
08	Clear Signal Detection Time (DID)	1~255 (100ms ~ 25500ms)	6 600ms
09	Clear Signal Detection Time (E&M)	1~255 (100ms ~ 25500ms)	6 600ms
10	Clear Signal Detection Time (OPX)	1~255 (100ms ~ 25500ms)	6 600ms
11	Ringing Signal Detection Time (Loop)	1~250 (8ms ~ 2000ms)	10 80ms
12	Ringing Signal Detection Time (Ground)	1~250 (8ms ~ 2000ms)	10 80ms
13	Ringing Signal Detection Time (DID)	1~250 (8ms ~ 2000ms)	10 80ms

Item	Name	Input Data	Default
14	Ringing Signal Detection Time (E&M)	1~250 (8ms ~ 2000ms)	10 80ms
15	Ringing Signal Detection Time (OPX)	1~250 (8ms ~ 2000ms)	10 80ms
16	Ringing Signal Stop Detection Time (Loop)	1~255 (100ms ~ 25500ms)	50 5000ms
17	Ringing Signal Stop Detection Time (Ground)	1~255 (100ms ~ 25500ms)	50 5000ms
18	Ringing Signal Stop Detection Time (DID)	1~255 (100ms ~ 25500ms)	50 5000ms
19	Ringing Signal Stop Detection Time (E&M)	1~255 (100ms ~ 25500ms)	50 5000ms
20	Ringing Signal Stop Detection Time (OPX)	1~255 (100ms ~ 25500ms)	50 5000ms
21	Loop Current Detection Time (Loop)	1~250 (4ms ~ 1000ms)	40 160ms
22	Loop Current Detection Time (Ground)	1~250 (4ms ~ 1000ms)	40 160ms
23	Loop Current Detection Time (DID)	1~250 (4ms ~ 1000ms)	40 160ms
24	Loop Current Detection Time (E&M)	1~250 (4ms ~ 1000ms)	40 160ms
25	Loop Current Detection Time (OPX)	1~250 (4ms ~ 1000ms)	40 160ms
26	DP Break Send Time (ALL)	1~250 (4ms ~ 1000ms)	15 60ms
27	DP Make Send Time (ALL)	1~250 (4ms ~ 1000ms)	10 40ms
28	DP InterDigit Send Time (ALL)	1~255 (100ms ~ 25500ms)	7 700ms
29	HookFlash Send Time (Loop)	1~255 (100ms ~ 25500ms)	5 500ms
30	HookFlash Send Time (Ground)	1~255 (100ms ~ 25500ms)	5 500ms
31	HookFlash Send Time (DID)	1~255 (100ms ~ 25500ms)	5 500ms
32	HookFlash Send Time (E&M)	1~255 (100ms ~ 25500ms)	5 500ms

Item	Name	Input Data	Default
33	HookFlash Send Time (OPX)	1~255 (100ms ~ 25500ms)	5 500ms
34	Pause Send Time (ALL)	1~255 (1sec ~ 255sec)	3 3sec
35	Wink Send Duration Time (DID)	1~250 (8ms ~ 2000ms)	25 200ms
36	Delay Send Duration Time (DID)	1~250 (8ms ~ 2000ms)	25 200ms
37	Incoming-Wink Send Time (DID)	1~255 (100ms ~ 25500ms)	3 300ms
38	Wink Send Duration Time (E&M)	1~250 (8ms ~ 2000ms)	25 200ms
39	Delay Send Duration Time (E&M)	1~250 (8ms ~ 2000ms)	25 200ms
40	Incoming-Wink Send Time (E&M)	1~255 (100ms ~ 25500ms)	3 300ms
41	Seizure-WINK/DELAY Receive Max. Time (DID)	1~255 (100ms ~ 25500ms)	48 4800ms
42	Receive Wink Duration Min. Time (DID)	1~250 (8ms ~ 2000ms)	12 96ms
43	Receive Wink Duration Max. Time (DID)	1~250 (8ms ~ 2000ms)	45 360ms
44	Seizure-WINK/DELAY Receive Max. Time (E&M)	1~255 (100ms ~ 25500ms)	48 4800ms
45	Receive Wink Duration Min. Time (E&M)	1~250 (8ms ~ 2000ms)	12 96ms
46	Receive Wink Duration Max. Time (E&M)	1~250 (8ms ~ 2000ms)	45 360ms
47	Receive DP Make Min. Time (ALL)	1~250 (4ms ~ 1000ms)	3 12ms
48	Receive DP Make Max. Time (ALL)	1~250 (4ms ~ 1000ms)	19 76ms
49	Receive DP Break Min. Time (ALL)	1~250 (4ms ~ 1000ms)	3 12ms
50	Receive DP Break Max. Time (ALL)	1~250 (4ms ~ 1000ms)	25 100ms
51	Receive DP InterDigit Min. Time (ALL)	1~250 (4ms ~ 1000ms)	125 500ms

Item	Name	Input Data	Default
52	Receive HookFlash Duration Min. Time (E&M)	1~255 (100ms ~ 25500ms)	3 300ms
53	Receive HookFlash Duration Max. Time (E&M)	1~255 (100ms ~ 25500ms)	6 600ms
54	Receive HookFlash Duration Min. Time (OPX)	1~255 (100ms ~ 25500ms)	3 300ms
55	Receive HookFlash Duration Max. Time (OPX)	1~255 (100ms ~ 25500ms)	6 600ms
56	Loop Off Guard Time (Loop)	1~255 (100ms ~ 25500ms)	20 2000ms
57	Loop Off Guard Time (Ground)	1~255 (100ms ~ 25500ms)	20 2000ms
58	Loop Off Guard Time (DID)	1~255 (100ms ~ 25500ms)	20 2000ms
59	Loop Off Guard Time (E&M)	1~255 (100ms ~ 25500ms)	20 2000ms
60	Loop Off Guard Time (OPX)	1~255 (100ms ~ 25500ms)	20 2000ms
61	Double Ringing Send Time 1 (OPX)	1~255 (100ms ~ 25500ms)	5 500ms
62	Double Between Ringing Send Time 1 (OPX)	1~255 (100ms ~ 25500ms)	5 500ms
63	Double Ringing Send Time 2 (OPX)	1~255 (100ms ~ 25500ms)	25 2500ms
64	Double Between Ringing Send Time 2 (OPX)	1~255 (100ms ~ 25500ms)	30 3000ms
65	Single Ringing Send Time (OPX)	1~255 (100ms ~ 25500ms)	10 1000ms
66	Receive DP Make Max. Time (ALL)	1~255 (100ms ~ 25500ms)	9 900ms
67	Receive DP Break Min. Time (ALL)	1~255 (100ms ~ 25500ms)	9 900ms
68	Receive DP Break Max. Time ALL)	1~255 (100ms ~ 25500ms)	9 900ms
69	Single Between Ringing Send Time (OPX)	1~255 (100ms ~ 25500ms)	9 900ms
70	Guard Time 1 (Loop)	1~255 (100ms ~ 25500ms)	9 900ms

Item	Name	Input Data	Default
71	Guard Time 1 (Ground)	1~255 (100ms ~ 25500ms)	9 900ms
72	Guard Time 1 (DID)	1~250 (4ms ~ 1000ms)	3 12ms
73	Guard Time 1 (E&M)	1~255 (100ms ~ 25500ms)	20 2000ms
74	Guard Time 1 (OPX)	1~255 (100ms ~ 25500ms)	40 4000ms
75	Guard Time 2 (ALL)	1~250 (4ms ~ 1000ms)	6 24ms
76	Dial Sending Complete Time (ALL)	1~255 (100ms ~ 25500ms)	6 600ms
77	ON-HOOK bit Send Time (ALL)	1~255 (100ms ~ 25500ms)	6 600ms
78	Open Loop Time (Loop)	1~255 (100ms ~ 25500ms)	6 600ms
79	Open Loop Time (Ground)	1~255 (100ms ~ 25500ms)	6 600ms
80	Open Loop Time (DID)	1~250 (4ms ~ 1000ms)	13 52ms
81	Open Loop Time (E&M)	1~250 (4ms ~ 1000ms)	13 52ms
82	Open Loop Time (OPX)	1~250 (4ms ~ 1000ms)	13 52ms

Conditions

None

Feature Cross Reference

None

Program 81 : Basic Hardware Setup for Trunk

81-09 : COT CODEC (QSLAC) Filter Setting

Level:
IN

Description

Use **Program 81-09 : COT CODEC (QSLAC) Filter Setting** to define the filter setting data (when Program 81-07 is set to 4).

Item	Name	Input Data	Default
01	B1 Filter Setup(1)	0~255	42
02	B1 Filter Setup(2)	0~255	90
03	B1 Filter Setup(3)	0~255	162
04	B1 Filter Setup(4)	0~255	42
05	B1 Filter Setup(5)	0~255	18
06	B1 Filter Setup(6)	0~255	178
07	B1 Filter Setup(7)	0~255	220
08	B1 Filter Setup(8)	0~255	55
09	B1 Filter Setup(9)	0~255	163
10	B1 Filter Setup(10)	0~255	42
11	B1 Filter Setup(11)	0~255	51
12	B1 Filter Setup(12)	0~255	36
13	B1 Filter Setup(13)	0~255	210
14	B1 Filter Setup(14)	0~255	64
15	B2 Filter Setup(1)	0~255	52
16	B2 Filter Setup(2)	0~255	176
17	AINSN and Analog Gains	0~255	0
18	Z Filter Coefficients(1)	0~255	34
19	Z Filter Coefficients(2)	0~255	172
20	Z Filter Coefficients(3)	0~255	178
21	Z Filter Coefficients(4)	0~255	164

Item	Name	Input Data	Default
22	Z Filter Coefficients(5)	0~255	202
23	Z Filter Coefficients(6)	0~255	181
24	Z Filter Coefficients(7)	0~255	170
25	Z Filter Coefficients(8)	0~255	78
26	Z Filter Coefficients(9)	0~255	51
27	Z Filter Coefficients(10)	0~255	78
28	Z Filter Coefficients(11)	0~255	171
29	Z Filter Coefficients(12)	0~255	162
30	Z Filter Coefficients(13)	0~255	182
31	Z Filter Coefficients(14)	0~255	159
32	Z Filter Coefficients(15)	0~255	1
33	R Filter Coefficients(1)	0~255	179
34	R Filter Coefficients(2)	0~255	208
35	R Filter Coefficients(3)	0~255	227
36	R Filter Coefficients(4)	0~255	32
37	R Filter Coefficients(5)	0~255	171
38	R Filter Coefficients(6)	0~255	169
39	R Filter Coefficients(7)	0~255	60
40	R Filter Coefficients(8)	0~255	37
41	R Filter Coefficients(9)	0~255	179
42	R Filter Coefficients(10)	0~255	162
43	R Filter Coefficients(11)	0~255	179
44	R Filter Coefficients(12)	0~255	43
45	R Filter Coefficients(13)	0~255	167
46	R Filter Coefficients(14)	0~255	180
47	X Filter Coefficients(1)	0~255	202
48	X Filter Coefficients(2)	0~255	48
49	X Filter Coefficients(3)	0~255	170
50	X Filter Coefficients(4)	0~255	171
51	X Filter Coefficients(5)	0~255	42
52	X Filter Coefficients(6)	0~255	45

Item	Name	Input Data	Default
53	X Filter Coefficients(7)	0~255	170
54	X Filter Coefficients(8)	0~255	164
55	X Filter Coefficients(9)	0~255	74
56	X Filter Coefficients(10)	0~255	159
57	X Filter Coefficients(11)	0~255	61
58	X Filter Coefficients(12)	0~255	79
59	GR Filter Coefficients(1)	0~255	171
60	GR Filter Coefficients(2)	0~255	65
61	GX Filter Coefficients(1)	0~255	194
62	GX Filter Coefficients(2)	0~255	224

Conditions

- This is used if Program 81-07 is set to 4 (Specified data).

Feature Cross Reference

None

Program 81 : Basic Hardware Setup for Trunk

81-10 : COT Initial Data Setup

Level:

IN

Description

Use **Program 81-10 : COT Initial Data Setup** to define the various basic timers for each COT trunk port.

Input Data

Trunk No.	1~ 200
-----------	--------

Item No.	Item	Input Data	Default
01	DP Interdigit Time Selection The DP Interdigit Time is the minimum pause time between dial pulses. Select either Pattern A or pattern B.	0 = Pattern A (Pattern A: 10pps – 650ms, 20pps – 50ms) 1 = Pattern B (Pattern B: 10pps – 800ms, 20pps – 80ms)	1 (Pattern B)
02	Prepause Time Selection Specify the loop open time for a hookflash signal sent to the CO or PBX when the Recall key on a multiline terminal is pressed. A single line telephone (SLT) generates a hookflash to the CO or PBX line when a SLT hookflash is assigned.	1~13 (1~13 seconds) (0 = No Setting)	1 (1sec)
03	Incoming Signal Detect Time Selection Specify the time after the incoming signal from another system is detected before the acknowledge signal is sent out.	0~15 (50~800ms)	3 (200ms)
04	Disconnect Recognition Time Selection Specify the minimum time before a disconnected circuit can be accessed again.	1~15 (100ms~1.5 seconds) (0 = No Setting)	3 (300ms)
05	Auto Release Signal Detection Time Specify the signal detection time for release of a CO/PBX line after a disconnect signal is received from the distant CO or PBX.	1~14 (50~700ms) 15 = <input type="checkbox"/> (No limit) (0 = No Setting)	7 (350ms)
06	Pause Time Selection	1~15 (500~7500ms)	6 (3000ms)

Item No.	Item	Input Data	Default
07	Hookflash Time Selection 1 Normal Hook Flash	0 = 20ms 1 = 40ms 2 = 60ms 3 = 80ms 4 = 100ms 5 = 140ms 6 = 160ms 7 = 200ms 8 = 400ms 9 = 600ms 10 = 800ms 11 = 1.0 second 12 = 1.5 seconds 13 = 2.0 seconds 14 = 3.0 seconds 15 = 5.0 seconds	9
08	Hookflash Time Selection 2 Long Hook Flash	0 = 20ms 1 = 40ms 2 = 60ms 3 = 80ms 4 = 100ms 5 = 140ms 6 = 160ms 7 = 200ms 8 = 400ms 9 = 600ms 10 = 800ms 11 = 1.0 second 12 = 1.5 seconds 13 = 2.0 seconds 14 = 3.0 seconds 15 = 5.0 seconds	14

Conditions

None

Feature Cross Reference

None

Program 81 : Basic Hardware Setup for Trunk

81-11 : Tie Line Initial Setup

Level:
IN

Description

Use **Program 81-11 : Tie Line Initial Setup** to define the various initial data for DID/ TLI/DTI packages.

Input Data

Trunk No.	1~ 200
-----------	--------

Item No.	Item	Input Data	Default
01	DP Interdigit Time Selection The DP Interdigit Time is the minimum pause time between dial pulses. Select either Pattern A or pattern B.	0 = Pattern A (Pattern A: 10pps – 650ms, 20pps – 500ms) 1 = Pattern B (Pattern B: 10pps – 800ms, 20pps – 800ms)	1
02	Prepause Time Selection Specify the loop open time for a hookflash signal sent to the Tie Line when the Recall key on a multiline terminal is pressed. A Single Line Telephone (SLT) generates a hookflash to the Tie Line when a SLT hookflash is assigned.	1~4 (1~4 = 0.5~2.0 seconds) (5~15 = 3.0~13 seconds) (0 = No Setting)	0 (No Setting)
03	Tie Line Answer Detect Time Selection Specify the time before a UNIVERGE SV8100 system answer (Off-Hook) is recognized as an answer.	0~15 (130ms~1950ms) (0 = No Setting)	4 (520ms)
04	Tie Line Release Detect Time Selection Specify the circuit disconnect detected on the Tie Line on the distant system side is recognized as Tie Line.	0~15 (130ms~1950ms) (0 = No Setting)	4 (520ms)

Item No.	Item	Input Data	Default
05	Incoming Signal Detect Time Selection Specify the time after the incoming signal from another system is detected before the acknowledge signal is sent out.	Wink Start 1~15 (130ms~1950ms) (0 = No Setting) Delay 1~15 (30ms~450ms) (0 = No Setting)	Wink Start 3 (390) Delay 3 (90)
06	Loop Off-Guard Time Selection Assign loop off-guard time to prevent noise that could cause the system to be unable to answer an incoming Tie line.	1~4 (0.5sec~2.0sec) 5~15 (3sec~13sec) (0 = No Setting)	4 (2.0)
07	Length of Wink Signal Selection Specify the time a wink pulse is sent to another system.	0~15 (30ms~480ms)	5 (180)
08	Length of Delay Signal Selection Specify the time a delay pulse is sent to another system.	1~15 (300ms~4.5sec) (0 = No Setting)	1 (300ms)
09	Incoming Interdigit Timeout Selection Specify the time that an address signal is missing during the incoming call detection process before an error tone is returned to the other system.	0 = 8 1~15 (1~15 seconds)	6
10	Wink/Delay Signal Detect Timeout Selection To specify a maximum time, in seconds, for receiving an acknowledgment signal from a distant system before sending a busy tone.	0 = 8 1~15 (1~15 seconds)	7
11	Disconnect Recognition Time Selection Specify the minimum time before a disconnected circuit can be accessed again.	1~15 (0.1~1.5 seconds) (0 = No Setting)	3 (0.3)
12	Automatic Release Signal Detection Selection Specify the signal detection time for release of a Tie Line after a disconnect signal is received from the distant CO or PBX.	1~14 (50~700ms) 15 = <input type="checkbox"/> (No limit) (0 = No Setting)	7 (350)
13	Pause Time Selection	1~15 (500~7500ms)	6 (3000ms)

Item No.	Item	Input Data	Default
14	Hookflash Time Selection 1	0 = 20ms 1 = 40ms 2 = 60ms 3 = 80ms 4 = 100ms 5 = 140ms 6 = 160ms 7 = 200ms 8 = 400ms 9 = 600ms 10 = 800ms 11 = 1.0 second 12 = 1.5 seconds 13 = 2.0 seconds 14 = 3.0 seconds 15 = 5.0 seconds	9 (600ms)
15	Hookflash Time Selection 2	0 = 20ms 1 = 40ms 2 = 60ms 3 = 80ms 4 = 100ms 5 = 140ms 6 = 160ms 7 = 200ms 8 = 400ms 9 = 600ms 10 = 800ms 11 = 1.0 second 12 = 1.5 seconds 13 = 2.0 seconds 14 = 3.0 seconds 15 = 5.0 seconds	14 (3.0sec)

Conditions

None

Feature Cross Reference

None

Program 81 : Basic Hardware Setup for Trunk

81-12 : Trunk Pad Level Data Setup

Level:

IN

Description

Use **Program 81-12 : Trunk Pad Level Data Setup** to define the various initial data for TLI/DTI/DID/BRT/PRT package.

Input Data

Trunk Number	1~200
--------------	-------

Item No.	Item	Input Data	Default
01	Internal Transmit Pad Level	0 = +2dB	3 = +8dB
02	Internal Receive Pad Level	1 = +4dB 2 = +6dB	3 = +8dB
03	External (tandem) Transmit Pad Level	3 = +8dB 4 = +12dB	8 = 0dB
04	External (tandem) Receive Pad Level	5 = +16dB 6 = +3dB 7 = -3dB 8 = 0dB	8 = 0dB

Conditions

None

Feature Cross Reference

None

Program 81 : Basic Hardware Setup for Trunk

81-14 : DIOPU (LD Trunk) CODEC (QSLAC) Filter Data Setup

Level:

IN

Description

Use Program 81-14 : DIOPU (LD Trunk) CODEC (QSLAC) Filter Data Setup to define the CODEC filter data.

Item No.	Item	Input Data	Default
01	B1 Filter Setup (1)	0~255	178
02	B1 Filter Setup (2)	0~255	90
03	B1 Filter Setup (3)	0~255	162
04	B1 Filter Setup (4)	0~255	186
05	B1 Filter Setup (5)	0~255	27
06	B1 Filter Setup (6)	0~255	50
07	B1 Filter Setup (7)	0~255	42
08	B1 Filter Setup (8)	0~255	45
09	B1 Filter Setup (9)	0~255	51
10	B1 Filter Setup (10)	0~255	173
11	B1 Filter Setup (11)	0~255	52
12	B1 Filter Setup (12)	0~255	179
13	B1 Filter Setup (13)	0~255	77
14	B1 Filter Setup (14)	0~255	48
15	B2 Filter Setup (1)	0~255	186
16	B2 Filter Setup (2)	0~255	160
17	AISN and Analog Gains	0~255	64
18	Z Filter Coefficients(1)	0~255	58
19	Z Filter Coefficients(2)	0~255	174
20	Z Filter Coefficients(3)	0~255	58
21	Z Filter Coefficients(4)	0~255	135

22	Z Filter Coefficients(5)	0~255	162
23	Z Filter Coefficients(6)	0~255	55
24	Z Filter Coefficients(7)	0~255	90
25	Z Filter Coefficients(8)	0~255	151
26	Z Filter Coefficients(9)	0~255	170
27	Z Filter Coefficients(10)	0~255	207
28	Z Filter Coefficients(11)	0~255	115
29	Z Filter Coefficients(12)	0~255	207
30	Z Filter Coefficients(13)	0~255	151
31	Z Filter Coefficients(14)	0~255	159
32	Z Filter Coefficients(15)	0~255	1
33	R Filter Coefficients(1)	0~255	29
34	R Filter Coefficients(2)	0~255	1
35	R Filter Coefficients(3)	0~255	171
36	R Filter Coefficients(4)	0~255	32
37	R Filter Coefficients(5)	0~255	187
38	R Filter Coefficients(6)	0~255	42
39	R Filter Coefficients(7)	0~255	162
40	R Filter Coefficients(8)	0~255	183
41	R Filter Coefficients(9)	0~255	50
42	R Filter Coefficients(10)	0~255	162
43	R Filter Coefficients(11)	0~255	35
44	R Filter Coefficients(12)	0~255	59
45	R Filter Coefficients(13)	0~255	66
46	R Filter Coefficients(14)	0~255	164
47	X Filter Coefficients(1)	0~255	1
48	X Filter Coefficients(2)	0~255	17
49	X Filter Coefficients(3)	0~255	1
50	X Filter Coefficients(4)	0~255	144
51	X Filter Coefficients(5)	0~255	1
52	X Filter Coefficients(6)	0~255	144
53	X Filter Coefficients(7)	0~255	1

54	X Filter Coefficients(8)	0~255	144
55	X Filter Coefficients(9)	0~255	1
56	X Filter Coefficients(10)	0~255	144
57	X Filter Coefficients(11)	0~255	1
58	X Filter Coefficients(12)	0~255	144
59	GR Filter Coefficients(1)	0~255	1
60	GR Filter Coefficients(2)	0~255	17
61	GX Filter Coefficients(1)	0~255	1
62	GX Filter Coefficients(2)	0~255	144

Conditions

- This Program is valid when Program 81-07 is set to filter type 4.
- This Program is not valid when Program 81-17 is set to option type 5~15.

Feature Cross Reference

None

Program 81 : Basic Hardware Setup for Trunk

81-15 : TLIU(2W) CODEC (QSLAC) Filter Data Setup

Level:
IN

Description

Use Program 81-15 : TLIU(2W) CODEC (QSLAC) Filter Data Setup to define the TLIU (2W) CODEC (QSLAC) Filter Data.

Item No.	Item	Input Data	Default
01	B1 Filter Setup (1)	0~255	195
02	B1 Filter Setup (2)	0~255	87
03	B1 Filter Setup (3)	0~255	162
04	B1 Filter Setup (4)	0~255	51
05	B1 Filter Setup (5)	0~255	34
06	B1 Filter Setup (6)	0~255	162
07	B1 Filter Setup (7)	0~255	171
08	B1 Filter Setup (8)	0~255	50
09	B1 Filter Setup (9)	0~255	179
10	B1 Filter Setup (10)	0~255	90
11	B1 Filter Setup (11)	0~255	50
12	B1 Filter Setup (12)	0~255	163
13	B1 Filter Setup (13)	0~255	42
14	B1 Filter Setup (14)	0~255	48
15	B2 Filter Setup (1)	0~255	36
16	B2 Filter Setup (2)	0~255	176
17	AISN and Analog Gains	0~255	64
18	Z Filter Coefficients(1)	0~255	165
19	Z Filter Coefficients(2)	0~255	173
20	Z Filter Coefficients(3)	0~255	43
21	Z Filter Coefficients(4)	0~255	213

22	Z Filter Coefficients(5)	0~255	170
23	Z Filter Coefficients(6)	0~255	54
24	Z Filter Coefficients(7)	0~255	34
25	Z Filter Coefficients(8)	0~255	190
26	Z Filter Coefficients(9)	0~255	166
27	Z Filter Coefficients(10)	0~255	47
28	Z Filter Coefficients(11)	0~255	50
29	Z Filter Coefficients(12)	0~255	181
30	Z Filter Coefficients(13)	0~255	163
31	Z Filter Coefficients(14)	0~255	159
32	Z Filter Coefficients(15)	0~255	1
33	R Filter Coefficients(1)	0~255	50
34	R Filter Coefficients(2)	0~255	208
35	R Filter Coefficients(3)	0~255	159
36	R Filter Coefficients(4)	0~255	32
37	R Filter Coefficients(5)	0~255	178
38	R Filter Coefficients(6)	0~255	169
39	R Filter Coefficients(7)	0~255	43
40	R Filter Coefficients(8)	0~255	164
41	R Filter Coefficients(9)	0~255	171
42	R Filter Coefficients(10)	0~255	35
43	R Filter Coefficients(11)	0~255	76
44	R Filter Coefficients(12)	0~255	59
45	R Filter Coefficients(13)	0~255	42
46	R Filter Coefficients(14)	0~255	180
47	X Filter Coefficients(1)	0~255	1
48	X Filter Coefficients(2)	0~255	17
49	X Filter Coefficients(3)	0~255	1
50	X Filter Coefficients(4)	0~255	144
51	X Filter Coefficients(5)	0~255	1
52	X Filter Coefficients(6)	0~255	144
53	X Filter Coefficients(7)	0~255	1

54	X Filter Coefficients(8)	0~255	144
55	X Filter Coefficients(9)	0~255	1
56	X Filter Coefficients(10)	0~255	144
57	X Filter Coefficients(11)	0~255	1
58	X Filter Coefficients(12)	0~255	144
59	GR Filter Coefficients(1)	0~255	1
60	GR Filter Coefficients(2)	0~255	17
61	GX Filter Coefficients(1)	0~255	1
62	GX Filter Coefficients(2)	0~255	144

Conditions

- This Program is valid when Program 81-07 is set to filter type 4.
- This Program is not valid when Program 81-17 is set to option type 5~15.

Feature Cross Reference

None

Program 81 : Basic Hardware Setup for Trunk

81-16 : TLIU(4W) CODEC (QSLAC) Filter Data Setup

Level:
IN

Description

Use Program 81-16 : TLIU(4W) CODEC (QSLAC) Filter Data Setup to define the TLIU (2W) CODEC (QSLAC) Filter Data.

Item No.	Item	Input Data	Default
01	B1 Filter Setup (1)	0~255	9
02	B1 Filter Setup (2)	0~255	0
03	B1 Filter Setup (3)	0~255	144
04	B1 Filter Setup (4)	0~255	9
05	B1 Filter Setup (5)	0~255	0
06	B1 Filter Setup (6)	0~255	144
07	B1 Filter Setup (7)	0~255	9
08	B1 Filter Setup (8)	0~255	0
09	B1 Filter Setup (9)	0~255	144
10	B1 Filter Setup (10)	0~255	9
11	B1 Filter Setup (11)	0~255	0
12	B1 Filter Setup (12)	0~255	144
13	B1 Filter Setup (13)	0~255	9
14	B1 Filter Setup (14)	0~255	0
15	B2 Filter Setup (1)	0~255	1
16	B2 Filter Setup (2)	0~255	144
17	AISN and Analog Gains	0~255	0
18	Z Filter Coefficients(1)	0~255	1
19	Z Filter Coefficients(2)	0~255	144
20	Z Filter Coefficients(3)	0~255	1
21	Z Filter Coefficients(4)	0~255	144

22	Z Filter Coefficients(5)	0~255	1
23	Z Filter Coefficients(6)	0~255	144
24	Z Filter Coefficients(7)	0~255	1
25	Z Filter Coefficients(8)	0~255	144
26	Z Filter Coefficients(9)	0~255	1
27	Z Filter Coefficients(10)	0~255	144
28	Z Filter Coefficients(11)	0~255	1
29	Z Filter Coefficients(12)	0~255	144
30	Z Filter Coefficients(13)	0~255	1
31	Z Filter Coefficients(14)	0~255	1
32	Z Filter Coefficients(15)	0~255	144
33	R Filter Coefficients(1)	0~255	46
34	R Filter Coefficients(2)	0~255	1
35	R Filter Coefficients(3)	0~255	1
36	R Filter Coefficients(4)	0~255	17
37	R Filter Coefficients(5)	0~255	1
38	R Filter Coefficients(6)	0~255	144
39	R Filter Coefficients(7)	0~255	1
40	R Filter Coefficients(8)	0~255	144
41	R Filter Coefficients(9)	0~255	1
42	R Filter Coefficients(10)	0~255	144
43	R Filter Coefficients(11)	0~255	1
44	R Filter Coefficients(12)	0~255	144
45	R Filter Coefficients(13)	0~255	1
46	R Filter Coefficients(14)	0~255	144
47	X Filter Coefficients(1)	0~255	1
48	X Filter Coefficients(2)	0~255	17
49	X Filter Coefficients(3)	0~255	1
50	X Filter Coefficients(4)	0~255	144
51	X Filter Coefficients(5)	0~255	1
52	X Filter Coefficients(6)	0~255	144
53	X Filter Coefficients(7)	0~255	1

54	X Filter Coefficients(8)	0~255	144
55	X Filter Coefficients(9)	0~255	1
56	X Filter Coefficients(10)	0~255	144
57	X Filter Coefficients(11)	0~255	1
58	X Filter Coefficients(12)	0~255	144
59	GR Filter Coefficients(1)	0~255	1
60	GR Filter Coefficients(2)	0~255	17
61	GX Filter Coefficients(1)	0~255	1
62	GX Filter Coefficients(2)	0~255	144

Conditions

- This Program is valid when Program 81-07 is set to filter type 4.
- This Program is not valid when Program 81-17 is set to option type 5~15.

Feature Cross Reference

None

Program 81 : Basic Hardware Setup for Trunk

81-17 : CODEC Filter Option Data Type Setup

Level:
IN

Description

Use Program 81-17 : CODEC Filter Option Data Type Setup to define the CODEC filter option data type.

Input Data

Line Type	1:COIU/082U(COIDB)/002U(COIDB) 2:DIOPU(LD Trunk) 3:TLIU(2W) 4:TLIU(4W)
-----------	---

Item No.	Item	Input Data	Default
01	Option Type	0 = None 1 = Type 5: 600Ω Line loss 2dB 2 = Type 6: China standard (200Ω+(100nF//680Ω)) 3 = Type7: China seimence tel (160Ω+(150nF//1100Ω)) 4 = Type 8: Brazil 900Ω 5 = Type 9: 600Ω Line loss 10dB 6 = Type 10: Reserved 7 = Type 11: Reserved 8 = Type 12: Reserved 9 = Type 13: Reserved 10 = Type 14: Reserved 11 = Type 15: for test	0

Conditions

None

Feature Cross Reference

None

THIS PAGE INTENTIONALLY LEFT BLANK

Program 82 : Basic Hardware Setup for Extension

82-01 : Incoming Ring Tone

Level:
MF

Program

82

Description

Use **Program 82-01 : Incoming Ring Tone** to set the incoming ring tones, which are the tones a user hears when a call rings an extension. These tones are grouped into four ring tone *Ranges* (1~4), also called patterns, that consist of a combination of frequencies. (You assign a specific *Range* to trunks in Program 22-03 and to extensions in Program 15-02.) Within each *Range* there are three frequency *Types*: High, Middle and Low. (Service Code 720 allows users to choose the *Type* for their incoming calls.) Each *Type* in turn consists of two frequencies and the modulation played simultaneously to make up the tone. These frequencies are determined by their Frequency Number selected in Items 1 and 2 (see below). In this program, you assign the two *Frequency Numbers* and *Modulation* for each *Type*, for each of the four *Ranges*. The chart below shows the default *Frequency Numbers* for each *Type* in each *Range*.

Input Data

Incoming Ringing Tone Number	1 = Pattern 1 (Trunk Incoming) 2 = Pattern 2 (Trunk Incoming) 3 = Pattern 3 (Trunk Incoming) 4 = Pattern 4 (Trunk Incoming) 5 = Intercom Incoming Pattern 6 = Alarm Sensor Tone Pattern
------------------------------	--

Ringling Tone Type Number	1 = High 2 = Mid 3 = Low
---------------------------	--------------------------------

Item No.	Item	Input Data
01	Frequency 1	1 = 520Hz
02	Frequency 2	2 = 540Hz
		3 = 660Hz
		4 = 760Hz
		5 = 1100Hz
		6 = 1400Hz
		7 = 2000Hz

Item No.	Item	Input Data
03	Modulation	0 = No Modulation 1 = 8Hz Modulation 2 = 16Hz Modulation 3 = Envelope

Default

Incoming Ringing Tone Number	Tone Type	Frequency 1 (Hz)	Frequency 2 (Hz)	Modulation
Pattern 1 (Trunk Incoming)	High Mid Low	1100 660 520	1400 760 660	16Hz Modulation 16Hz Modulation 16Hz Modulation
Pattern 2 (Trunk Incoming)	High Mid Low	1100 660 520	1400 760 660	8Hz Modulation 8Hz Modulation 8Hz Modulation
Pattern 3 (Trunk Incoming)	High Mid Low	2000 1400 1100	760 660 540	16Hz Modulation 16Hz Modulation 16Hz Modulation
Pattern 4 (Trunk Incoming)	High Mid Low	2000 1400 1100	760 660 540	8Hz Modulation 8Hz Modulation 8Hz Modulation
Pattern 5 Intercom Incoming Pattern	High Mid Low	1100 660 520	1400 760 660	8Hz Modulation 8Hz Modulation 8Hz Modulation
Pattern 6 Alarm Sensor Pattern	High Mid Low	760 760 760	760 760 760	No Modulation No Modulation No Modulation

Conditions

None

Feature Cross Reference

- Distinctive Ringing Tones and Flash Patterns
- Selectable Ring Tones

Program 82 : Basic Hardware Setup for Extension

82-03 : DSS Console LED Pattern Setup

Level:
MF

Description

Use **Program 82-03 : DSS Console LED Pattern Setup** to define the LED patterns for special functions on a DSS console.

Input Data

Item No.	Item	Input Data	Default
01	ACD Log In	0~7	1
02	ACD Log Out	0~7	4
03	ACD Emergency Call	0~7	3

LED Pattern 0 : [OFF]



LED Pattern 1 : [FL: On(500ms)/Off(500ms)]

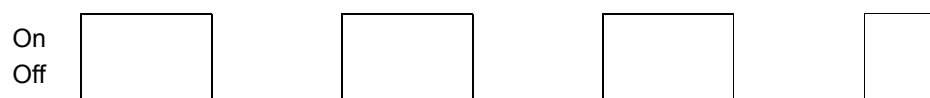

LED Pattern 2 : [WK: On(250ms)/Off(250ms)]

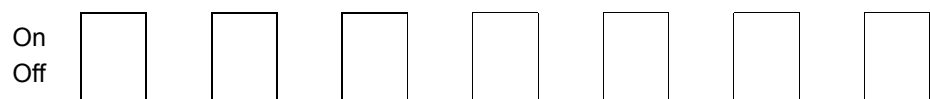

LED Pattern 3 : [RW: On(125ms)/Off(125ms)]

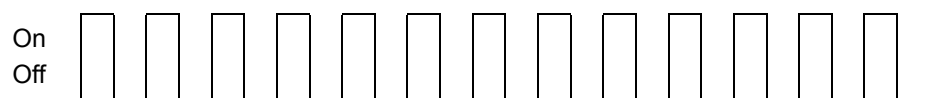

LED Pattern 4 : [IR: On(125ms)/Off(125ms)/On(125ms)/Off(625ms)]

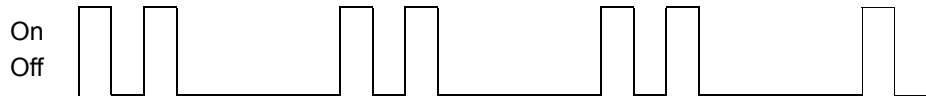

LED Pattern 5 : [IL: On(875ms)/Off(125ms)]



LED Pattern 6 : [IW: On(625ms)/Off(125ms)/On(125ms)/Off(125ms)]

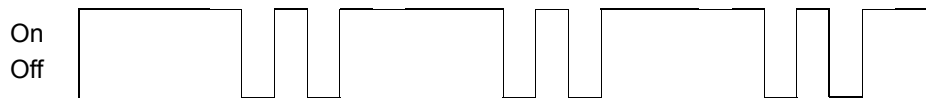

LED Pattern 7 : [ON]



Conditions

None

Feature Cross Reference

- Direct Station Selection (DSS)

Program 82 : Basic Hardware Setup for Extension

82-04 : LCA Initial Data Setup

Level:

MF

Description

Use **Program 82-04 : LCA Initial Data Setup** to set the basic data of the LCA.

Input Data

Item No.	Item	Input Data	Default
01	Companding Method Type	0 = μ -law 1 = A-law	0
02	Ringling Frequency	0 = 25Hz 1 = 20Hz 2 = 16Hz	1 (20Hz)
03	Minimum Break Time	1~255 (5ms~1275ms)	2 (10ms)
04	Maximum Break Time	1~255 (5ms~1275ms)	20(100ms)
05	Minimum Make Time	1~255 (5ms~1275ms)	2 (10ms)
06	Maximum Make Time	1~255 (5ms~1275ms)	20 (100ms)
07	Minimum Hook Flash Time	1~255 (5ms~1275ms)	21 (105ms)
08	Maximum Hook Flash Time	1~255 (5ms~1275ms)	200 (1000ms)
09	Minimum Ground Flash Time	1~255 (5ms~1275ms)	21 (105ms)
10	Minimum Off-Hook Time	1~255 (5ms~1275ms)	21 (105ms)
11	No Detection Time after Off-Hook	1~255 (5ms~1275ms)	60 (300ms)
12	No Detection Time after Pulse Dial Detection	1~255 (5ms~1275ms)	70 (350ms)
13	Loop Disconnect Time, Reversal Time	1~255 (10ms~2550ms)	60 (600ms)
14	Ring, Message Wait Period Time	1~255 (5ms~1275ms)	150 (750ms)

Conditions

None

Feature Cross Reference

None

Program 82 : Basic Hardware Setup for Extension

82-07 : CODEC Filter Setup for Analog Station Port

Level:

IN

Description

Use Program 82-07 : **CODEC Filter Setup for Analog Station Port** to set the filter value of the CODEC (QSLAC) filter of each analog port.

Input Data

Station Port Number	1~ 256
---------------------	--------

CODEC Filter Type	Default
0 = No filter 1 = Type 1 2 = Type 2 3 = Type 3 4 = Type 4	3

Conditions

None

Feature Cross Reference

- Direct Station Selection (DSS)

Program 82 : Basic Hardware Setup for Extension

82-08 : Sidetone Volume Setup

Level:
MF

Description

Use **Program 82-08 : Sidetone Volume Setup** for adjusting the telephone sidetone volume.

There are two levels, based on whether the connected trunk is a digital trunk or analog trunk.

Input Data

Item No.	Description	Input	Digital Sidetone Level	Analog Sidetone Level
01	Sidetone Volume	0	-54 (dB)	-54 (dB)
		1	-48 (dB)	-54 (dB)
		2	-42 (dB)	-54 (dB)
		3	-36 (dB)	-48 (dB)
		4	-30 (dB)	-42 (dB)
		5	-24 (dB)	-36 (dB)
		6 (default)	-18 (dB)	-30 (dB)
		7	-12 (dB)	-24 (dB)
		8	-12 (dB)	-18 (dB)
		9	-12 (dB)	-12 (dB)

Conditions

None

Feature Cross Reference

- Central Office Calls, Answering
- Central Office Calls, Placing

Program 82 : Basic Hardware Setup for Extension

82-09 : LCA CODEC Filter Data Setup

Level:
IN

Description

Use **Program 82-09 : LCA CODEC Filter Data Setup** to define the filter setting data (when Program 82-07 is set to 4).

Input Data

Item	Name	Input Data	Default
01	B1 Filter Setup(1)	0~255	58
02	B1 Filter Setup(2)	0~255	242
03	B1 Filter Setup(3)	0~255	191
04	B1 Filter Setup(4)	0~255	44
05	B1 Filter Setup(5)	0~255	90
06	B1 Filter Setup(6)	0~255	165
07	B1 Filter Setup(7)	0~255	168
08	B1 Filter Setup(8)	0~255	123
09	B1 Filter Setup(9)	0~255	159
10	B1 Filter Setup(10)	0~255	185
11	B1 Filter Setup(11)	0~255	246
12	B1 Filter Setup(12)	0~255	159
13	B1 Filter Setup(13)	0~255	201
14	B1 Filter Setup(14)	0~255	240
15	B2 Filter Setup(1)	0~255	221
16	B2 Filter Setup(2)	0~255	1
17	AISN and Analog Gains	0~255	21
18	Z Filter Coefficients(1)	0~255	163
19	Z Filter Coefficients(2)	0~255	201
20	Z Filter Coefficients(3)	0~255	36
21	Z Filter Coefficients(4)	0~255	163

Input Data

Item	Name	Input Data	Default
22	Z Filter Coefficients(5)	0~255	59
23	Z Filter Coefficients(6)	0~255	194
24	Z Filter Coefficients(7)	0~255	196
25	Z Filter Coefficients(8)	0~255	195
26	Z Filter Coefficients(9)	0~255	170
27	Z Filter Coefficients(10)	0~255	43
28	Z Filter Coefficients(11)	0~255	38
29	Z Filter Coefficients(12)	0~255	193
30	Z Filter Coefficients(13)	0~255	163
31	Z Filter Coefficients(14)	0~255	188
32	Z Filter Coefficients(15)	0~255	1
33	R Filter Coefficients(1)	0~255	46
34	R Filter Coefficients(2)	0~255	1
35	R Filter Coefficients(3)	0~255	1
36	R Filter Coefficients(4)	0~255	17
37	R Filter Coefficients(5)	0~255	1
38	R Filter Coefficients(6)	0~255	144
39	R Filter Coefficients(7)	0~255	1
40	R Filter Coefficients(8)	0~255	144
41	R Filter Coefficients(9)	0~255	1
42	R Filter Coefficients(10)	0~255	144
43	R Filter Coefficients(11)	0~255	1
44	R Filter Coefficients(12)	0~255	144
45	R Filter Coefficients(13)	0~255	1
46	R Filter Coefficients(14)	0~255	144
47	X Filter Coefficients(1)	0~255	37
48	X Filter Coefficients(2)	0~255	64
49	X Filter Coefficients(3)	0~255	83
50	X Filter Coefficients(4)	0~255	171
51	X Filter Coefficients(5)	0~255	42

Input Data

Item	Name	Input Data	Default
52	X Filter Coefficients(6)	0~255	135
53	X Filter Coefficients(7)	0~255	35
54	X Filter Coefficients(8)	0~255	52
55	X Filter Coefficients(9)	0~255	71
56	X Filter Coefficients(10)	0~255	172
57	X Filter Coefficients(11)	0~255	43
58	X Filter Coefficients(12)	0~255	197
59	GR Filter Coefficients(1)	0~255	66
60	GR Filter Coefficients(2)	0~255	97
61	GX Filter Coefficients(1)	0~255	162
62	GX Filter Coefficients(2)	0~255	176

Conditions

- This is used if Program 82-07 is set to 4 (Specified data).

Feature Cross Reference

None

Program 82 : Basic Hardware Setup for Extension

82-11 : LCA Initial Data Setup

Level:
IN

Description

Use **Program 82-11 : LCA Initial Data Setup** to define the various timers for LCA Packages.

Input Data

Item No.	Item	Description	Input	Default
01	Bounce Protect Time	Specify a time for detection of a valid off-Hook indication that is long enough to prevent an unintentional bounce of the receiver from being detected as a new Off-Hook indication from a Single Line Telephone.	0 = No Setting 1~15 = 100ms~1.5sec	3 (300ms)
02	HookFlash Start Time	Specify the minimum hookflash time from a Single Line Telephone or analog Voice Mail system before it is detected as the beginning of a valid hookflash.	0 = 40ms 1~15 = 90ms~790ms	5 (450ms)
03	HookFlash End Time	Specify the maximum hookflash duration from a Single Line Telephone to receive a second dial tone.	0 = HST+0ms 1~15 = HST+100ms~HST+1500ms (HST=Hookflash Start Time)	7 (700ms)

Conditions

None

Feature Cross Reference

None

Program 82 : Basic Hardware Setup for Extension

82-12 : OPX Initial Data Setup

Level:

IN

Description

Use **Program 82-12 : OPX Initial Data Setup** to define the various initial data for OPX packages.

Input Data

Item No.	Item	Description	Input	Default
01	Bounce Protect Time	Specify a time for detection of a valid off-Hook indication that is long enough to prevent an unintentional bounce of the receiver from being detected as a new Off-Hook indication from a single line telephone.	0 = No Setting 1~15 = 100ms~1.5sec	3 (300ms)
02	HookFlash Start Time	Specify the minimum hookflash time from a single line telephone or analog Voice Mail system before it is detected as the beginning of a valid hookflash.	0 = 40ms 1~15 = 90ms~790ms	5 (450ms)
03	HookFlash End Time	Specify the maximum hookflash duration from a single line telephone to receive a second dial tone.	0 = HST+0ms 1~15=HST+100ms~HST+1500ms (HST=Hookflash Start Time)	7 (700ms)

Conditions

None

Feature Cross Reference

None

Program 82 : Basic Hardware Setup for Extension

82-14 : Handset/Headset Gain for Multiline Telephone

Level:

IN

Description

Use **Program 82-14 : Handset/Headset Gain for Multiline Telephone** to set the sending and receiving gain of the Multiline telephone handset.

Input Data

Item No.	Item	Description	Input	Default
01	Handset Transmit Gain Level	The handset gain level is set for sending (transmit).	1~32 (-3.5dB, , +58.5dB) 2dB basis 0 = Fixed Value (+12.5db)	0
02	Headset Receive Gain Level	The headset gain level is set for receiving (hearing).	1~32 (-3.5dB, , +58.5dB) 2dB basis 0 = Fixed Value (0db)	0

Conditions

None

Feature Cross Reference

None

Program 82 : Basic Hardware Setup for Extension

82-15 : OPX CODEC (QSLAC) Filter Data Setup

Level:
IN

Description

Use **Program 82-15 : OPX CODEC (QSLAC) Filter Data Setup** to define the filter data setup information (when Program 82-07 is set to 4).

Input Data

Item	Name	Input Data	Default
01	B1 Filter Setup(1)	0~255	202
02	B1 Filter Setup(2)	0~255	125
03	B1 Filter Setup(3)	0~255	164
04	B1 Filter Setup(4)	0~255	34
05	B1 Filter Setup(5)	0~255	71
06	B1 Filter Setup(6)	0~255	69
07	B1 Filter Setup(7)	0~255	169
08	B1 Filter Setup(8)	0~255	123
09	B1 Filter Setup(9)	0~255	135
10	B1 Filter Setup(10)	0~255	248
11	B1 Filter Setup(11)	0~255	254
12	B1 Filter Setup(12)	0~255	143
13	B1 Filter Setup(13)	0~255	168
14	B1 Filter Setup(14)	0~255	240
15	B2 Filter Setup(1)	0~255	46
16	B2 Filter Setup(2)	0~255	1
17	AISN and Analog Gains	0~255	50
18	Z Filter Coefficients(1)	0~255	170
19	Z Filter Coefficients(2)	0~255	42
20	Z Filter Coefficients(3)	0~255	106
21	Z Filter Coefficients(4)	0~255	35

Input Data

Item	Name	Input Data	Default
22	Z Filter Coefficients(5)	0~255	69
23	Z Filter Coefficients(6)	0~255	162
24	Z Filter Coefficients(7)	0~255	210
25	Z Filter Coefficients(8)	0~255	165
26	Z Filter Coefficients(9)	0~255	202
27	Z Filter Coefficients(10)	0~255	187
28	Z Filter Coefficients(11)	0~255	52
29	Z Filter Coefficients(12)	0~255	163
30	Z Filter Coefficients(13)	0~255	177
31	Z Filter Coefficients(14)	0~255	51
32	Z Filter Coefficients(15)	0~255	208
33	R Filter Coefficients(1)	0~255	46
34	R Filter Coefficients(2)	0~255	1
35	R Filter Coefficients(3)	0~255	1
36	R Filter Coefficients(4)	0~255	17
37	R Filter Coefficients(5)	0~255	1
38	R Filter Coefficients(6)	0~255	144
39	R Filter Coefficients(7)	0~255	1
40	R Filter Coefficients(8)	0~255	144
41	R Filter Coefficients(9)	0~255	1
42	R Filter Coefficients(10)	0~255	144
43	R Filter Coefficients(11)	0~255	1
44	R Filter Coefficients(12)	0~255	144
45	R Filter Coefficients(13)	0~255	1
46	R Filter Coefficients(14)	0~255	144
47	X Filter Coefficients(1)	0~255	1
48	X Filter Coefficients(2)	0~255	17
49	X Filter Coefficients(3)	0~255	1
50	X Filter Coefficients(4)	0~255	144
51	X Filter Coefficients(5)	0~255	1

Input Data

Item	Name	Input Data	Default
52	X Filter Coefficients(6)	0~255	144
53	X Filter Coefficients(7)	0~255	1
54	X Filter Coefficients(8)	0~255	144
55	X Filter Coefficients(9)	0~255	1
56	X Filter Coefficients(10)	0~255	144
57	X Filter Coefficients(11)	0~255	1
58	X Filter Coefficients(12)	0~255	144
59	GR Filter Coefficients(1)	0~255	1
60	GR Filter Coefficients(2)	0~255	17
61	GX Filter Coefficients(1)	0~255	1
62	GX Filter Coefficients(2)	0~255	144

Conditions

None

Feature Cross Reference

None

Program 82 : Basic Hardware Setup for Extension

82-16 : SLI CODEC (QSLAC) Filter Data Setup

Level:
IN

Description

Use **Program 82-16 : SLI CODEC (QSLAC) Filter Data Setup** to define the filter data setup information (when Program 82-07 is set to 4).

Input Data

Item	Name	Input Data	Default
01	B1 Filter Setup(1)	0~255	58
02	B1 Filter Setup(2)	0~255	242
03	B1 Filter Setup(3)	0~255	191
04	B1 Filter Setup(4)	0~255	44
05	B1 Filter Setup(5)	0~255	90
06	B1 Filter Setup(6)	0~255	165
07	B1 Filter Setup(7)	0~255	168
08	B1 Filter Setup(8)	0~255	123
09	B1 Filter Setup(9)	0~255	159
10	B1 Filter Setup(10)	0~255	185
11	B1 Filter Setup(11)	0~255	246
12	B1 Filter Setup(12)	0~255	159
13	B1 Filter Setup(13)	0~255	201
14	B1 Filter Setup(14)	0~255	240
15	B2 Filter Setup(1)	0~255	221
16	B2 Filter Setup(2)	0~255	1
17	AINSN and Analog Gains	0~255	21
18	Z Filter Coefficients(1)	0~255	163
19	Z Filter Coefficients(2)	0~255	201
20	Z Filter Coefficients(3)	0~255	36
21	Z Filter Coefficients(4)	0~255	163

Input Data

Item	Name	Input Data	Default
22	Z Filter Coefficients(5)	0~255	59
23	Z Filter Coefficients(6)	0~255	194
24	Z Filter Coefficients(7)	0~255	196
25	Z Filter Coefficients(8)	0~255	195
26	Z Filter Coefficients(9)	0~255	170
27	Z Filter Coefficients(10)	0~255	43
28	Z Filter Coefficients(11)	0~255	38
29	Z Filter Coefficients(12)	0~255	193
30	Z Filter Coefficients(13)	0~255	163
31	Z Filter Coefficients(14)	0~255	188
32	Z Filter Coefficients(15)	0~255	1
33	R Filter Coefficients(1)	0~255	46
34	R Filter Coefficients(2)	0~255	1
35	R Filter Coefficients(3)	0~255	1
36	R Filter Coefficients(4)	0~255	17
37	R Filter Coefficients(5)	0~255	1
38	R Filter Coefficients(6)	0~255	144
39	R Filter Coefficients(7)	0~255	1
40	R Filter Coefficients(8)	0~255	144
41	R Filter Coefficients(9)	0~255	1
42	R Filter Coefficients(10)	0~255	144
43	R Filter Coefficients(11)	0~255	1
44	R Filter Coefficients(12)	0~255	144
45	R Filter Coefficients(13)	0~255	1
46	R Filter Coefficients(14)	0~255	144
47	X Filter Coefficients(1)	0~255	37
48	X Filter Coefficients(2)	0~255	64
49	X Filter Coefficients(3)	0~255	83
50	X Filter Coefficients(4)	0~255	171
51	X Filter Coefficients(5)	0~255	42

Input Data

Item	Name	Input Data	Default
52	X Filter Coefficients(6)	0~255	135
53	X Filter Coefficients(7)	0~255	35
54	X Filter Coefficients(8)	0~255	52
55	X Filter Coefficients(9)	0~255	71
56	X Filter Coefficients(10)	0~255	172
57	X Filter Coefficients(11)	0~255	43
58	X Filter Coefficients(12)	0~255	197
59	GR Filter Coefficients(1)	0~255	66
60	GR Filter Coefficients(2)	0~255	97
61	GX Filter Coefficients(1)	0~255	162
62	GX Filter Coefficients(2)	0~255	176

Conditions

None

Feature Cross Reference

None

Program 82 : Basic Hardware Setup for Extension

82-17 : CODEC Filter Option Data Type Setup

Level:

IN

Description

Use Program 81-17 : CODEC Filter Option Data Type Setup to define the CODEC filter option data type.

Input Data

Line Type	1 = SLIU 2 = OPX 3 = SLI
-----------	--------------------------------

Item No.	Item	Input Data	Default
01	Option Type	0 = None 1 = Type 5 2 = Type 6 3 = Type 7 4 = Type 8 5 = Type 9 6 = Type 10 7 = Type 11 8 = Type 12 9 = Type 13 10 = Type 14 11 = Type 15	0

Conditions

None

Feature Cross Reference

None

THIS PAGE INTENTIONALLY LEFT BLANK

Program 84 : Hardware Setup for VoIP

84-01 : H.323 Trunk Basic Information Setup

Level:
IN

Description

Use **Program 84-01 : H.323 Trunk Basic Information Setup** to set the basic information of the H.323 Trunk.

Input Data

Item No.	Item	Input Data	Default
02	Number of G.711 audio frames	1~4	3
03	G.711 VAD mode	0 = Disable 1 = Enable	0
04	G.711 Type	0 = A-law 1 = μ -law	1
05	Number of G.729 audio frames	1~6 1 = 10ms 2 = 20ms 3 = 30ms 4 = 40ms 5 = 50ms 6 = 60ms	3
06	G.729 VAD mode	0 = Disable 1 = Enable	0
07	G.729 Jitter Buffer(min)	0~270ms	30
08	G.729 Jitter Buffer (average)	0~270ms	60
09	G.729 Jitter Buffer (max)	0~270ms	120
11	Number of G.723 audio frames	1~2	1
12	G.723 VAD mode	0 = Disable 1 = Enable	0
13	--- Not Used ---		

Program

84

Input Data

Item No.	Item	Input Data	Default
15	Jitter Buffer Mode	1 = Fixed 2 = Self adjusting (silence period) 3 = Self adjusting	3
16	G.711 Jitter Buffer(min)	0~160	30
17	G.711 Jitter Buffer (average)	0~160	60
18	G.711 Jitter Buffer (max)	0~160	120
19	G.723 Jitter Buffer(min)	0~270	30
20	G.723 Jitter Buffer (average)	0~270	60
21	G.723 Jitter Buffer (max)	0~270	120
22	VAD Threshold	0~30 (-19dB~ +10dB and self adjustment) 0 = Self adjustment 1 = -19dB (-49dBm) : 20 = 0dB (-30dBm) : 29 = 9dB (-21dBm) 30 = 10dB (-20dBm)	20
23	Idle Noise Level	-5000dBm ~ -7000dBm	7000
24	Echo Canceller Mode	0 = Disable 1 = Enable	1
25	Signal Limiter Mode	1 = Mode 0 2 = Mode 1 3 = Mode 2 4 = Mode 3 5 = Mode 4 6 = Mode 5	6
26	Echo Canceller NLP Mode	0 = 2 wire and 4 wire 1 = 2 wire only	1
28	Echo Canceller NLP Noise Setting	0 = Automatic level adjustment 1 = Fixed level	0
30	TX Gain	0~40 (-20dBm~ +20dBm)	20
31	RX Gain	0~40 (-20dBm~ +20dBm)	20
33	Priority CODEC setting Priority of voice encoding method.	0~3 0 = G.711 1 = G.723 2 = G.729 3 = G.722	0

Input Data

Item No.	Item	Input Data	Default
34	--- Not Used ---		
35	--- Not Used ---		
36	The Maximum FAX Transmission Rate	0 = V.27ter, 2400bps 1 = V.27ter, 4800bps 2 = V.29, 7200bps 3 = V.29, 9600bps 4 = V.17, 12000bps 5 = V.17, 14400bps	5
37	FAX FIFO Considering Delay Time	0~600ms	300
38	Size of FAX Packet	20~48 bytes	20
39	FAX Modem Transmission Level	0~13 (0dBm ~ -13dBm)	9
40	FAX Modem Carrier Signal Detection Threshold	0 = -26dBm 1 = -33dBm 2 = -43dBm	1
41	FAX Communication no Communication Time-Out	10~32000 seconds	30
43	High-speed Signal Data (fax picture signal) Packet Length	1 = 10ms 2 = 20ms 3 = 30ms 4 = 40ms	4
44	Low-speed Signal Data (FAX Procedure Signal)	0~5	0
45	High-speed Signal Data (FAX Procedure Signal)	0~2	0
46	TCF Operation Setting	1 = Training signal (TCF) of the fax is locally generated and checked. 2 = Training signal (TCF) of the fax is sent over the network.	1
47	The Maximum, Low-speed Signal Data (Size of Packet)	1~65535 bytes	1
48	Network Transmission Time-out	10~32000 seconds	150
49	Eflag Beginning Timer	0~65535	2600
50	Eflag Stop Timer	0~65535	2300
51	The Former Line Substitution of Scanning Line (FAX Relay item)	0 = Disable 1 = Enable	1

Input Data

Item No.	Item	Input Data	Default
52	Eflag Setting at Head DIS (FAX Relay item)	0 = Disable 1 = Enable	1
53	TFOP Protocol (FAX Relay item)		1
54	NSF Superscription (FAX Relay item)		0
55	ECM (Error Correction Mode)		1
56	Enable Modified Read Code		1
57	NSF Country Code Setting	0~65535	0
58	NSF Vendor Code Setting		0
59	FAX Relay Function	0 = Disable 1 = Enable 2 = Each port mode	0
61	Auto Gain Control	0~5	0
62	DTMF Relay Mode Set up information of VoIP is set by PRG 84-06-10.	0 = VoIP 1 = RFC2833 2 = H.245 3 = Disable	0
63	Number of G.722 audio frames	1~4 1 = 10ms 2 = 20ms 3 = 30ms 4 = 40ms	3
64	G.722 Voice Activity Detection Mode	0 = Disable 1 = Enable	0
65	G.722 Jitter Buffer (min)	0~160ms	30
66	G.722 Jitter Buffer (average)	0~160ms	60
67	G.722 Jitter Buffer (max)	0~160ms	120

Conditions

None

Feature Cross Reference

- Voice Over Internet Protocol (VoIP)

Program 84 : Hardware Setup for VoIP

84-02 : H.225 and H.245 Information Basic Setup

Level:
IN

Description

Use **Program 84-02 : H.225 and H.245 Information Basic Setup** to define the basic setup information of H.225 and H.245.

Input Data

Item No.	Item	Input Data	Default
01	H.225	0~255sec	180
02	H.225 Setup Acknowledge Timer	0~255sec	9
03	H.225 Setup Timer	0~255sec	4
04	H.225 Info Ack Timer	0~255sec	9
05	H.225 Call Proceeding Timer	0~255sec	10
07	H.245 Master Slave Determination Timer	0~255sec	5
08	H.245 Master Slave Determination Retry Count	0~255sec	3
09	H.245 Capability Exchange Timer	0~255sec	5
10	H.245 Logical Channel Establishment Timer	0~255sec	50
11	H.245 Mode Request Procedures Timer	0~255sec	50
12	H.245 Close Logical Channel Timer	0~255sec	50
13	H.245 Round Trip Delay Timer	0~255sec	50
14	H.245 Maintenance Loop	0~255sec	50
15	RAS GRQ Timer	0~255sec	5
16	GRQ Retry Count	0~255	2
17	RAS RRQ Timer	0~255sec	5
18	RRQ Retry Count	0~255	3
19	RAS URQ Timer	0~255sec	3
20	URQ Retry Count	0~255	1
21	RAS ARQ Timer	0~255sec	5

Input Data

Item No.	Item	Input Data	Default
22	ARQ Retry Count	0~255	2
23	RAS BRQ Timer	0~255sec	5
24	BRQ Retry Count	0~255	2
25	RAS IRR Timer	0~255sec	5
26	IRR Retry Count	0~255	2
27	RAS DRQ Timer	0~255sec	8
28	DRQ Retry Count	0~255	2
29	RAS LRQ Timer	0~255sec	5
30	LRQ Retry Count	0~255	2
31	RAS RAI Timer	0~255sec	3
32	RAI Retry Count	0~255	2
33	Call Signaling Port Number	0~65535: 0~1719, 1721~65535	1730
35	Fast Start Mode	0 = Disable 1 = Enable	1
36	RAS Unicast Port Number	0~65535	20001
37	Terminal Type setting	0~255	60

Conditions

None

Feature Cross Reference

- Voice Over Internet Protocol (VoIP)

Program 84 : Hardware Setup for VoIP

84-03 : IP Phone Information Basic Setup

Level:
IN

Description

Use **Program 84-03 : IP Phone Information Basic Setup** to define the details of IP Terminals and Adapters.

Input Data

Terminal Type	1 = D^{term} IP / UNIVERGE SV8100 Multiline Terminal with IP Adapter 2 = Soft Phone 3 = Bundle IP Phone
---------------	---

Item No.	Item	Input Data	Default
01	Port Number for Dterm IP Reception	0~65535	3458
02	DRS Port Number	0~65535	3456
06	Area Number	0 = Japan 1 = USA 2 = Australia 3 = EU 4 = Asia 5 = Other Country 6 = Germany 7 = Italy 8 = Netherlands 9 = Austria 10 = Belgium 11 = Spain 12 = Sweden 13 = UK 14 = Denmark 15 = Greece 16 = Switzerland 17 = RSA 18 = New Zealand	1
07	Type of Service Mode	1 = Invalid 2 = IP Precedence 3 = Diffserve	1

Item No.	Item	Input Data	Default
08	Type of Service	0x00~0xFF	C0
09	Start Port Number	1~42	1
10	Signaling Server Port	0~65535	5029
11	Negotiation Timer	0~255 (sec)	5

Conditions

None

Feature Cross Reference

Voice Over Internet Protocol (VoIP)

Program 84 : Hardware Setup for VoIP

84-06 : PVA Data Setting

Level:
IN

Description

Use **Program 84-06 : PVA Data Setting** to set up threshold levels of every CD-PVAA slot.

(This program is not available with V1000)

(This program is available only via telephone programming and not through PC Programming).

Input Data

Slot Number	01~24
-------------	-------

Item No.	Item	Input Data	Default	Description
01	RTP Port Number	0~65534	10020	
02	RTCP Port Number	RTP Port Number + 1	10021	It has to be RTP Port Number + 1.
04	Fract Lost Threshold	0~100%	0	The data is sent to the CD-CP00-US if the value exceeds the defined value.
05	Packets Lost Threshold	0~16777215	0	The data is sent to the CD-CP00-US if the value exceeds the defined value.
07	Jitter Threshold	0~4294967295 (sec)	0	The data is sent to the CD-CP00-US if the value exceeds the defined value.
09	Delay LSR Threshold	0~4294967295 (sec)	0	The data is sent to the CD-CP00-US if the value exceeds the defined value.
16	IMCP Redirect	0=No 1=Yes	0	The VOIP blade supports sending the Internet Message Control Protocol (IMCP) redirect message.

Conditions

- System programming must be exited before these program options take affect.

Feature Cross Reference

- Voice Over Internet Protocol (VoIP)

Program 84 : Hardware Setup for VoIP

84-07 : Firmware Download Setup

Level:
IN

Description

Use **Program 84-07 : Firmware Download Setup** to configure the settings related to Central Firmware Download for IP phones.

Input Data

Item No.	Item	Input Data	Default
01	Server Mode	0 = TFTP 1 = FTP	0
02	File Server IP Address	0.0.0.0~126.255.255.254 128.0.0.1~191.255.255.254 192.0.1.1~223.255.254.254	0.0.0.0
03	Login Name	Up to 20 Characters	None
04	Password	Up to 20 Characters	None

Conditions

None

Feature Cross Reference

None

Program 84 : Hardware Setup for VoIP

84-08 : Firmware Name Setup

Level:

IN

Description

Use **Program 84-08 : Firmware Name Setup** to set up the directory and filename for the firmware that is downloaded to IP phones.

Input Data

Terminal Type	1 = IP Terminal 2 = IP Adapter
---------------	-----------------------------------

Input Data

Item No.	Item	Input Data	Default
02	Firmware File Name	Up to 30 Characters	None

Conditions

None

Feature Cross Reference

None

Program 84 : Hardware Setup for VoIP

84-09 : VLAN Setup

Level:
IN

Description

Use **Program 84-09 : VLAN Setup** to set up the VLAN data for Ethernet interface ports.

Input Data

Ethernet Interface	1 = CPU 2 = IPLA
--------------------	---------------------

Input Data

Item No.	Item	Input Data	Default
01	VLAN (Future Use)	0 = Disable (Off) 1 = Enable (On)	0
02	VLAN ID (Future Use)	1~4094	0
03	Priority (Future Use)	0~7	0

Conditions

- System programming must be exited before these program options take affect.

Feature Cross Reference

- Voice Over Internet Protocol (VoIP)

Program 84 : Hardware Setup for VoIP

84-10 : ToS Setup

Level:
IN

Description

Use **Program 84-10 : ToS Setup** to set up the Type of Service data.

Input Data

Protocol Type	1 = Not Used 2 = Not Used 3 = Voice Control 4 = H.323 5 = RTP/RTCP 6 = SIP 7 = CCISoIP 8 = DT700 MLT 9 = SIP Trunk 10 = NetLink
---------------	--

Item No.	Item	Input Data	Default	Description
01	ToS Mode	0 = Disable (Invalid) 1 = IP Precedence 2 = Diffserv	0	When Input Data is set to 1, Item No. 07 is invalid. When Data is set to 2, Item No. 02 ~ 06 are invalid.
02	Priority, IP Precedence	0~7 0 = Low 7 = High	0	1 = Router queuing priority
03	Low Delay	0~1 0 = Normal Delay, Low Delay	0	1 = Optimize for low delay routing
04	Wideband (Throughout)	0~1 0 = Normal Throughput 1 = High Throughput	0	1 = Optimize for high bandwidth routing
05	High Reliability	0~1 0 = Normal Reliability 1 = Low Reliability	0	1 = Optimize for reliability routing
07	Priority (D.S.C.P. - Differentiated Services Code Point)	0~63	0	DSCP (Differentiated Services Code Point)

Conditions

- The system must be reset for these program options to take affect.

Feature Cross Reference

- Voice Over Internet Protocol (VoIP)

Program 84 : Hardware Setup for VoIP

84-11 : *D^{term}*® IP CODEC Information Basic Setup

Level:
IN

Description

Use **Program 84-11 : *D^{term}*® IP CODEC Information Basic Setup** to set voice (RTP packet) encoding parameters.

Input Data

Type	1~5
------	-----

Item No.	Item	Input Data	Default
01	Number of G711 Audio Frames	1~4 (10ms steps)	3
02	G711 VAD mode	0 = Disable 1 = Enable	0
03	G711 Type	0 = A-law 1 = μ -law	1
04	G.711 Jitter Buffer Min	0~160ms	30
05	G.711 Jitter Buffer Average	0~160ms	60
06	G.711 Jitter Buffer Max	0~160ms	120
07	Number of G.729 Audio Frames	1~6	3
08	G.729 VAD mode	0 = Disable 1 = Enable	0
09	G.729 Jitter Buffer Min	0~270ms	30
10	G.729 Jitter Buffer Average	0~270ms	60
11	G.729 Jitter Buffer Max	0~270ms	120
12	Number of G723 Audio Frames	1~2	1
13	G723 VAD mode	0 = Disable 1 = Enable	0
14	G.723 Jitter Buffer Min	0~270ms	30
15	G.723 Jitter Buffer Average	0~270ms	60

Item No.	Item	Input Data	Default
16	G.723 Jitter Buffer Max	0~270ms	120
17	Jitter Buffer Mode	1 = Static 2 = Adaptive during silence 3 = Adaptive immediate	3
18	VAD Threshold	0~30 = -19dB~+10dB 0 = Adaptec Threshold 1 = -19dB(-49dBm) : 20 = 0dB (-30dBm) : 29 = 9dBm(-21dBm) 30 = 10dBm(-20dBm)	20
19	Idle Noise Level	5000~7000 (-5000dBm~ -7000dBm)	7000
20	Echo Canceller Mode	0 = Disable 1 = Enable	1
21	Signal Limiter	1 = Mode 0 2 = Mode 1 3 = Mode 2 4 = Mode 3 5 = Mode 4 6 = Mode 5 1. There is no limitation. 2. The limitation is the maximum. 3. Limitation size 4. It is limiting it. 5. Limitation smallness 6. The limitation is minimum.	6
22	Echo Canceller NLP Mode When the NLP mode is turned on, the voice with low level is replaced with the NLP noise. As a result, a low echo of the level is usually removed compared with the conversation level.	0 = 2 wire and 4 wire 1 = 2 wire only	1

Item No.	Item	Input Data	Default
24	Echo Canceller Cng Cfg It is invalid if 84-11-22 is disabled. Setting of noise level adjusting method added with NLP. 0: A set value of the self adjustment. 1: 84-01-27 is used.	0 = Adaptive 1 = Fixed	0
26	TX Gain	0~40 (-20dBm~+20dBm) 0 = -14dBm 1 = -13dBm : 14 = 0dBm : 19 = 5dBm 20 = 6dBm	14
27	RX Gain	0~40 (-20dBm~+20dBm) 0 = -14dBm 1 = -13dBm : 14 = 0dBm : 19 = 5dBm 20 = 6dBm	14
28	Audio Capability Priority	0 = G.711_PT 2 = G.729_PT	0

Conditions

None

Feature Cross Reference

- Voice Over Internet Protocol (VoIP)

Program 84 : Hardware Setup for VoIP

84-13 : SIP Trunk CODEC Information Basic Setup

Level:
IN

Description

Use **Program 84-13 : SIP Trunk CODEC Information Basic Setup** to set up the basic CODEC options for SIP trunks.

Input Data

Item No.	Item	Input Data	Default
01	Number of G.711 Audio Frames	1~4 (1 = 10ms, 4 = 40ms)	2
02	G.711 Voice Activity Detection Mode	0 = Disable 1 = Enable	0
03	G.711 Type	0 = A-law 1 = μ -law	1
04	G.711 Jitter Buffer (min)	0~160ms	20
05	G.711 Jitter Buffer (average)	0~160ms	40
06	G.711 Jitter Buffer (max)	0~160ms	80
07	Number of G.729 Audio Frames	1~6 (1 = 10ms, 6 = 60ms)	2
08	G.729 Voice Activity Detection Mode	0 = Disable 1 = Enable	0
09	G.729 Jitter Buffer (min)	0~270ms	20
10	G.729 Jitter Buffer (average)	0~270ms	40
11	G.729 Jitter Buffer (max)	0~270ms	80
12	Number of G.723 Audio Frames	1~2	1
13	G.723 Voice Activity Detection Mode	0 = Disable 1 = Enable	0
14	G.723 Jitter Buffer (min)	0~270ms	30
15	G.723 Jitter Buffer (average)	0~270ms	60

Input Data

Item No.	Item	Input Data	Default
16	G.723 Jitter Buffer (max)	0~270ms	120
17	Jitter Buffer Mode	1 = Fixed 2 = Adaptive during silence 3 = Adaptive Immediately	3
18	VAD Threshold	0~30 (-19dB~+10dB) 0 = Self adjustment 1 = -19dB (-49dBm) : 2 = 0dB (-30dBm) : 29 = 9dBm (-21dBm) 30 = 10dBm (-20dBm)	20
19	Idle Noise Level	5000~7000 (-5000dBm~ -7000dBm)	7000
20	Echo Canceller Mode	0 = Disable 1 = Enable	1
21	Signal Limiter	1 = Mode 0 2 = Mode 1 3 = Mode 2 4 = Mode 3 5 = Mode 4 6 = Mode 5 1. There is no limitation. 2. The limitation is the maximum. 3. Limitation size 4. It is limiting it. 5. Limitation smallness 6. The limitation is minimum.	6
22	Echo Canceller NLP Mode When the NLP mode is turned on, the voice with low level is replaced with the NLP noise. As a result, a low echo of the level is usually removed compared with the conversation level.	0 = 2 wire and 4 wire 1 = 2 wire only	1

Input Data

Item No.	Item	Input Data	Default
24	Echo Canceller Cng Cfg It is invalid if 84-11-22 is disabled. Setting of noise level adjusting method added with NLP. 0: A set value of the self adjustment. 1: 84-01-27 is used.	0 = Adaptive 1 = Fixed	0
26	TX Gain	0~40 (-20dBm ~ +20dBm) 0 = -20dBm 1 = -19 dBm : 20 = 0dBm : 39 = 19dBm 40 = 20dBm	20
27	RX Gain	0~40 (-20dBm ~ +20dBm) 0 = -20dBm 1 = -19 dBm : 20 = 0dBm : 39 = 19dBm 40 = 20dBm	20
28	Audio Capability Priority	0 = G.711_PT 1 = G.723_PT 2 = G.729_PT 3 = G.722_PT 4 = G.726_PT 5 = Not Used	0
31	DTMF Payload Number	96~127	110
32	DTMF Relay Mode	0 = Disable 1 = RFC2833	0
33	Number of G.722 Audio Frames	1~4 1 = 10ms 2 = 20ms 3 = 30ms 4 = 40ms	3
34	G.722 VAD Mode	0 = Disable 1 = Enable	0
35	G.722 Jitter Buffer (min)	0~160ms	30

Input Data

Item No.	Item	Input Data	Default
36	G.722 Jitter Buffer (average)	0~160ms	60
37	G.722 Jitter Buffer (max)	0~160ms	120
38	Number of G.726 Audio Frames	1~4 (1 = 10ms, 4 = 40ms)	3
39	G.726 VAD Mode	0 = Disable 1 = Enable	0
40	G.726 Jitter Buffer (min)	0~160ms	30
41	G.726 Jitter Buffer (average)	0~160ms	60
42	G.726 Jitter Buffer (max)	0~160ms	120
43	--- Not Used ---		
44	--- Not Used ---		
45	--- Not Used ---		
46	--- Not Used ---		
47	--- Not Used ---		
48	--- Not Used ---		

Conditions

None

Feature Cross Reference

None

Program 84 : Hardware Setup for VoIP

84-14 : SIP Trunk Basic Information Setup

Level:
IN

Description

Use **Program 84-14 : SIP Trunk Basic Information Setup** to define the basic setup for SIP trunks.

Input Data

Item No.	Item	Input Data	Default
01	INVITE ReTx Count Specifies the number of times the INVITE message is sent.	0~255	7
02	Request ReTx Count Specifies the number of times Request message except INVITE are sent.		11
03	Response ReTx Count Specifies the number of times the Response message is sent.		7
04	Request ReTx Start Time	0~65535 (0ms~6553.5sec.)	5(500ms)
05	Request Maximum ReTx Interval		40(4000ms)
06	SIP Trunk Port Number	1~65535	5060
07	Session Timer Value	1~65535	0
08	Minimum Session Timer Value	1~65535	1800
09	Called Party Information	0 = Request URI 1 = To Header	0
10	URL Type	0 = SIP-URL 1 = TEL-URL	0

Input Data

Item No.	Item	Input Data	Default
11	URL/To HeaderSetting Information 0: If 10-29-12 and 10-29-13 are set for the Proxy server domain, the value is put. The value of 10-29-11 is put on the URL/TO header when not set. 1: Information is acquired and put from 10-28-01/10-28-02 of the SIP UA domains.	0 = Proxy Server Domain 1 = SIP UA Domain	0

Conditions

None

Feature Cross Reference

None

Program 84 : Hardware Setup for VoIP

84-15 : H.323/SIP Phone Keep Alive Setup

Level:
IN

Description

Use **Program 84-15 : H.323/SIP Phone Keep Alive Setup** to set the Keep Alive Configuration of the H.323/SIP phone.

Input Data

Item No.	Item	Input Data	Default
01	Registration Information Automatic Deletion When set to 1, the registration information is automatically deleted (for H.323).	0 = Disable 1 = Enable	0
02	Keep Alive Message Interval Time interval that system sends a Ping to the terminal.	1~10 minutes	1
03	Keep Alive Message Timeout Time that system waits for a Ping response from the terminal.	1~10 seconds	5
04	Keep Alive Timeout How many times the system waits for a non response before determining the terminal is down.	1~5 times	3

Conditions

None

Feature Cross Reference

None

Program 84 : Hardware Setup for VoIP

84-16 : VoIP Limiter Control Gain Setup

Level:
IN

Description

Use **Program 84-16 : VoIP Limiter Control Gain** to set the Limiter Control Gain configuration of VoIP.

Input Data

Item No.	Item	Input Data	Default
01	RX Limiter Control Gain Gain setting to control limiter in the direction of IP → PCM. This option adds gain to the voice input from the LAN and removes it from the voice output to highway.	0~30 (-15dBm ~ +15dBm) 0 = -15dBm 1 = -14dBm : 15 = 0dBm : 29 = 14dBm 30 = 15dBm	15 (0dBm)
02	TX Limiter Control Gain Gain setting to control limiter in the direction of PCM → IP. This option adds the gain to the voice input from highway and removes it from the voice output to the LAN.		15 (0dBm)
03	RX Limiter Control Gain (CD-4COTB) This option controls the limiter gain for a COIU call in the IP to PCM direction.		15 (0dBm)
04	TX Limiter Control Gain (CD-4COTB) This option controls the limiter gain for a COIU call in the PCM to IP direction.		15 (0dBm)

Conditions

None

Feature Cross Reference

- Voice Over Internet Protocol (VoIP)

Program 84 : Hardware Setup for VoIP

84-19 : SIP Extension CODEC Information Basic Setup

Level:
IN

Description

Use **Program 84-19 : SIP Extension CODEC Information Basic Setup** to define the CODEC information for the SIP extensions.

Input Data

Item No.	Item	Input Data	Default
01	Number of G.711 Audio Frames	1~4 1 = 10ms 2 = 20ms 3 = 30ms 4 = 40ms	2
02	G.711 Voice Activity Detection Mode	0 = Disabled 1 = Enabled	0
03	G.711 Type	0 = A-law 1 = μ -law	1
04	G.711 Jitter Buffer (min)	0~160ms	20
05	G.711 Jitter Buffer (Average)	0~160ms	40
06	G.711 Jitter Buffer (max)	0~160ms	80
07	Number of G.729 Audio Frames	1~6 1 = 10ms 2 = 20ms 3 = 30ms 4 = 40ms 5 = 50ms 6 = 60ms	2
08	G.729 Voice Activity Detection Mode	0 = Disabled 1 = Enabled	0
09	G.729 Jitter Buffer (min)	0~270ms	20
10	G.729 Jitter Buffer (average)	0~270ms	40
11	G.729 Jitter Buffer (max)	0~270ms	80

Input Data

Item No.	Item	Input Data	Default
12	Number of G.723 Audio Frames	1~2	1
13	G.723 Voice Activity Detection Mode	0 = Disable 1 = Enable	0
14	G.723 Jitter Buffer (min)	0~270ms	30
15	G.723 Jitter Buffer (average)	0~270ms	60
16	G.723 Jitter Buffer (max)	0~270ms	120
17	Jitter Buffer Mode	1 = Static 2 = Adaptive during Silence 3 = Adaptive Immediately	3
18	VAD Threshold	0~30	20
19	Idle Noise Level	5000~7000 (-5000dBm~ -7000dBm)	7000
20	Echo Canceller Mode	0 = Disable 1 = Enable	1
21	Signal Limiter	1 = Mode 0 2 = Mode 1 3 = Mode 2 4 = Mode 3 5 = Mode 4 6 = Mode 5 1. There is no limitation. 2. The limitation is the maximum. 3. Limitation size 4. It is limiting it. 5. Limitation smallness 6. The limitation is minimum.	6
22	Echo Canceller NLP Mode When the NLP mode is turned on, the voice with low level is replaced with the NLP noise. As a result, a low echo of the level is usually removed compared with the conversation level.	0 = 2 wire and 4 wire 1 = 2 wire only	1

Input Data

Item No.	Item	Input Data	Default
24	Echo Canceller Cng Cfg It is invalid if 84-11-22 is disabled. Setting of noise level adjusting method added with NLP. 0: A set value of the self adjustment. 1: 84-01-27 is used.	0 = Adaptive 1 = Fixed	0
26	TX Gain	0~30 (-19dB ~ +10dB, Auto) 0 = Auto Adjust 1 = -19dB (-49dBm) : 20 = 0dB (-30dBm) : 29 = +9dB (-21dBm) 30 = +10dB (-20dBm)	20
27	RX Gain	0~40 (-20dBm ~ +20dBm) 0 = -20dBm 1 = -19dBm : 20 = 0dBm : 39 = +19dBm 40 = +20dBm	20
28	Audio Capability Priority	0 = G.711_PT 1 = G.723_PT 2 = G.729_PT 3 = G.722 4 = G.726 5 = Not Used	0
31	DTMF Payload Number	96~127	96
32	DTMF Relay Mode	0 = Disable 1 = RFC2833	0
33	Number of G.722 Audio Frames	1~4 1 = 10ms 2 = 20ms 3 = 30ms 4 = 40ms	3
34	G.722 Voice Activity Detection Mode	0 = Disabled 1 = Enabled	0

Input Data

Item No.	Item	Input Data	Default
35	G.722 Jitter Buffer (min)	0~160ms	30
36	G.722 Jitter Buffer (Average)	0~160ms	60
37	G.722 Jitter Buffer (max)	0~160ms	120
38	Number of G.726 Audio Frames	1~4 (1 = 10ms, 4 = 40ms)	3
39	G.726 Voice Activity Detection Mode	0 = Disable 1 = Enable	0
40	G.726 Jitter Buffer (min)	0~160ms	30
41	G.726 Jitter Buffer (Average)	0~160ms	60
42	G.726 Jitter Buffer (max)	0~160ms	120
43	--- Not Used ---		
44	--- Not Used ---		
45	--- Not Used ---		
46	--- Not Used ---		
47	--- Not Used ---		
48	--- Not Used ---		

Conditions

- These commands are for SIP analog extensions.

Feature Cross Reference

None

Program 84 : Hardware Setup for VoIP

84-20 : SIP Extension Basic Information Setup

Level:
IN

Description

Use **Program 84-20 : SIP Extension Basic Information Setup** to set up proxy information, session timers, called party information and expire value of invite.

Input Data

Item No.	Item	Input Data	Default
01	Registrar/Proxy Port	1~65535	5070
02	Session Timer Value	0~65535	180
03	Minimum Session Timer Value	0~65535	180
04	Called Party Info	0 = Request URI 1 = To Header	0
05	Expire Value of Invite Arrival of a message is ended when this time expires and there is no cut from the caller.	0~256 (seconds)	180s
06	Expire Value of Invite (send) The expiration time is set for the Invite message.	1~3600 (seconds)	180s

Conditions

- These commands are for SIP analog extensions.

Feature Cross Reference

None

Program 84 : Hardware Setup for VoIP

84-21 : CCIS over IP CODEC Information Basic Setup

Level:
IN

Description

Use **Program 84-21 : CCIS over IP CODEC Information Basic Setup** to set the codec parameters of the PZ-32IPLA, PZ-64IPLA, and PZ-128IPLA.

Input Data

Item No.	Item	Input Data	Default
01	Number of G.711 Audio Frames	1~4 1 = 10ms 2 = 20ms 3 = 30ms 4 = 40ms	3
02	G.711 Type	0 = A-law 1 = μ -law	1
03	G.711 Voice Activity Detection Mode	0 = Disable 1 = Enable	0
04	G.711 Jitter Buffer Min	0~160ms	30
05	G.711 Jitter Buffer Average	0~160ms	60
06	G.711 Jitter Buffer Max	0~160ms	120
07	G.729 Audio Frame Number	1~6 1 = 10ms 2 = 20ms 3 = 30ms 4 = 40ms 5 = 50ms 6 = 60ms	3
08	G.729 Voice Activity Detection Mode	0 = Disable 1 = Enable	0
09	G.729 Jitter Buffer Min	0~270ms	30
10	G.729 Jitter Buffer Average	0~270ms	60
11	G.729 Jitter Buffer Max	0~270ms	120

Input Data

Item No.	Item	Input Data	Default
12	G.723 Audio Frame Number	1 = 30ms 2 = 60ms	1
13	G.723 Voice Activity Detection Mode	0 = Disable 1 = Enable	0
14	G723 Jitter Buffer Min	0~270ms	30
15	G723 Jitter Buffer Average	0~270ms	60
16	G.723 Jitter Buffer Max	0~270ms	120
17	TX Gain	0~40 (-20dBm ~ +20dBm) 0 = -20 dBm 1 = -19 dBm : 20 = 0 dBm : 39 = +19 dBm 40 = +20 dBm	20
18	RX Gain	0~40 (-20dBm ~ +20dBm) 0 = -20 dBm 1 = -19 dBm : 20 = 0 dBm : 39 = +19 dBm 40 = +20 dBm	20
19	1st Priority of Audio Capability	0 = G.711 PT 1 = G.723 PT 2 = G.729 PT 3 = G.722 4 = G.726 5 = Not Used	0
20	2nd Priority of Audio Capability	0 = G.711 PT 1 = G.723 PT 2 = G.729 PT 3 = G.722 PT 4 = G.726 PT 5 = Not Used	1
21	DTMF Relay Mode	0 = Disable 1 = Inbound (RFC2833) 2 = Outbound (H.245)	0
22	Jitter Buffer Mode	1 = Static 2 = Silence 3 = Immediate	3

Input Data

Item No.	Item	Input Data	Default
23	Voice Activity Detection Threshold	0 = Self adjustment 1 = -19dBm (-49dBm) : 20 = 0dBm (-30dBm) : 29 = +9dBm (-21dBm) 30 = +10dBm (-20dBm)	20
24	Echo Canceller Mode	0 = Disable 1 = Enable	1
25	NLP Echo Canceller Mode	0 = Disable 1 = Enable	1
26	UDP Checksum Mode	0 = Disable 1 = Enable	1
27	G.722 Audio Frame Number	1~4 1 = 10ms 2 = 20ms 3 = 30ms 4 = 40ms	3
28	G.722 Voice Activity Detection Mode	0 = Disabled 1 = Enabled	0
29	G.722 Jitter Buffer (min)	0~160ms	30
30	G.722 Jitter Buffer (Average)	0~160ms	60
31	G.722 Jitter Buffer (max)	0~160ms	120
32	G.726 Audio Frame Number	1~4 1 = 10ms 2 = 20ms 3 = 30ms 4 = 40ms	3
33	G.726 Voice Activity Detection Mode	0 = Disabled 1 = Enabled	0
34	G.726 Jitter Buffer (min)	0~160ms	30
35	G.726 Jitter Buffer (Average)	0~160ms	60
36	G.726 Jitter Buffer (max)	0~160ms	120
37	--- Not Used ---		
38	--- Not Used ---		
39	--- Not Used ---		

Input Data

Item No.	Item	Input Data	Default
40	--- Not Used ---		
41	--- Not Used ---		
42	FAX Relay Mode	0 = Disable 1 = Enable 2 = Each Port Mode (each extension)	0

Conditions

None

Feature Cross Reference

- Voice Over Internet Protocol (VoIP)

Program 84 : Hardware Setup for VoIP

84-22 : DT700 Multiline Logon Information Setup

Level:
IN

Description

Use **Program 84-22 : DT700 Multiline Logon Information Setup** to set the DT700 Multiline logon information.

Input Data

Personal ID Index	1~512
-------------------	-------

Input Data

Item No.	Item	Input Data	Default
01	User ID Input the User ID when using manual or auto registration (10-46-01).	Up to 32 characters	No Setting
02	Password Input the Password when using manual or auto registration (10-46-01).  <i>IP Multiline terminals only support numerical user IDs, not alphanumeric.</i>	Up to 16 characters	No Setting
03	User ID Omission Input the Personal ID from terminal automatically when log on again.	0 = Off 1 = On	0
04	Log Off When the registration mode (10-46-01) is set to manual, and the phone prompts for a login, the previous user ID appears so the user only has to enter the password. When enabled, the extension assigned to the Personal ID Index can be logged off or overridden by another IP multiline station or Softphone. In Manual mode, a user can also log off the IP phone to allow another user to login with their own login ID and password. To logoff the IP phone use the following operation: Press the "Down Arrow" Soft Key, press the "Prog" soft key, and then press the "LOGOFF" soft key.	0 = Off 1 = On	1

Input Data

Item No.	Item	Input Data	Default
05	Nick Name Input the Personal ID from terminal automatically when log on again.	Up to 32 characters	No Setting

Conditions

None

Feature Cross Reference

- Voice Over Internet Protocol (VoIP)

Program 84 : Hardware Setup for VoIP

84-23 : DT700 Multiline Basic Information Setup

Level:
IN

Description

Use **Program 84-23 : DT700 Multiline Basic Information Setup** to set the basic information for the DT700 Multiline Terminal.

Input Data

Item No.	Item	Input Data	Default
01	Registration Expire Timer The Expires value of the REGISTER message which received from DT700 terminal is out of range or when the Expire value is not set up, in case it assigns the effective time to the DT700 terminal. The timer for supervising whether DT700 terminal is connected or not.	60~65535 (sec)	180
02	Subscribe Expire Timer The subscribe Expire timer to transmit and receive the terminal operation instructions between the Main Device and DT700 terminal.	60~65535 (sec)	3600
03	Session Expire Timer Set effective time for supervising the Voice Path.	60~65535 (sec)	180
04	Minimum Session Expire Timer Set minimum value of effective time for supervising the Voice Path.	60~65535 (sec)	180
05	Invite Expire Timer Set effective time for Incoming/Outgoing call when the Expire value is not set in the INVITE message received from DT700 terminal.	0~65535 (sec)	180
06	Signal Type of Service Set Type of Service value which applied to send SIP Message Packet from DT700 terminal to Main Device.	0x00~0xFF (0~9, A~F)	00
07	Error Display Timer	0~65535 (sec)	0

Input Data

Item No.	Item	Input Data	Default
08	Digest Authorization Registration Expire Timer	0~4294967295 (sec)	0
10	Number of Password Retries Input the number of times an incorrect password can be entered when the security key is pressed.	0~255	0
11	Password Lock Time	0~120	0
12	Reference Number	Up to 32 digits (0~9, *, #, P, R, @)	No Setting
13	Media Type of Service	0x00~0xFF (0~9, A~F)	00
14	Refer Expire Timer	0~65535 (sec)	60

Conditions

None

Feature Cross Reference

- Voice Over Internet Protocol (VoIP)

Program 84 : Hardware Setup for VoIP

84-24 : DT700 Multiline CODEC Basic Information Setup

Level:
IN

Description

Use **Program 84-24 : DT700 Multiline CODEC Basic Information Setup** to set the codec of each type of DT700 Multiline Telephone.

Input Data

Type	1 = Type 1 2 = Type 2 3 = Type 3 4 = Type 4 5 = Type 5
------	--

Item No.	Item	Input Data	Default
01	Number of G.711 Audio Frames Input the amount of audio in the packets when using the G.711 CODEC.	1~4 1 = 10ms 2 = 20ms 3 = 30ms 4 = 40ms	2
02	--- Not Used ---		
03	G.711 Type This decides the G.711 type. In North America, typically u-law is used.	0 = A-law 1 = μ -law	1
04	G.711 Jitter Buffer Min	0~160ms	20
05	G.711 Jitter Buffer Average	0~160ms	40
06	G.711 Jitter Buffer Max	0~160ms	80
07	Number of G.729 Audio Frames	1~4 1 = 10ms 2 = 20ms 3 = 30ms 4 = 40ms	2
08	--- Not Used ---		
09	G729 Jitter Buffer Min	0~270ms	20
10	G729 Jitter Buffer Average	0~270ms	40

Item No.	Item	Input Data	Default
11	G729 Jitter Buffer Max	0~270ms	80
17	Jitter Buffer Mode	1 = Static 2 = Adaptive during silence 3 = Adaptive immediate	3
18	--- Not Used ---		
19	Idle Noise Level	5000~7000 (-5000dBm~ -7000dBm)	7000
20	Echo Canceller Mode	0 = Disable 1 = Enable	1
21	Signal Limiter Mode	1 = Mode 0 2 = Mode 1 3 = Mode 2 4 = Mode 3 5 = Mode 4 6 = Mode 5	6
22	Echo Canceller NLP Mode	0 = 2 wire and 4 wire 1 = 2 wire only	1
24	Echo Canceller CNG Configuration	0 = Adaptive 1 = Fixed	0
26	TX Gain Input the TX gain from the IPLA to the telephone.	0~40 (-14dBm~+14dBm) 0 = -20dBm 1 = -19dBm : 20 = 0dBm : 39 = 19dBm 40 = 20dBm	20
27	RX Gain Input the RX gain from the IPLA to the telephone.	0~40 (-14dBm~+14dBm) 0 = -20dBm 1 = -19dBm : 20 = 0dBm : 39 = 19dBm 40 = 20dBm	20
28	Audio Capability Priority	0~3 0 = G.711_PT 2 = G.729_PT 3 = G.722_PT	0

Item No.	Item	Input Data	Default
30	Auto Gain Control Auto (0) means that the system automatically decides a type (Type 4 or Type 5) of echo canceller on PRG 84-17 for a telephone on the basis of a seized trunk.	0~5	0
32	G.722 Audio Frame Number	1~4 1 = 10ms 2 = 20ms 3 = 30ms 4 = 40ms	3
33	--- Not Used ---		
34	G.722 Jitter Buffer (min)	0~160ms	30
35	G.722 Jitter Buffer (Average)	0~160ms	60
36	G.722 Jitter Buffer (max)	0~160ms	120

Conditions

None

Feature Cross Reference

- Voice Over Internet Protocol (VoIP)

Program 84 : Hardware Setup for VoIP

84-25 : NetLink CODEC Information Basic Setup

Level:
IN

Description

Use **Program 84-25 : NetLink CODEC Information Basic Setup** to set the CODEC with NetLink.

Input Data

Item No.	Item	Input Data	Default
01	Number of G.711 Audio Frames	1~4 1 = 10ms 2 = 20ms 3 = 30ms 4 = 40ms	3
02	G.711 Voice Activity Detection Mode	0 = Disable 1 = Enable	0
03	G.711 Type	0 = A-law 1 = μ -law	1
04	G.711 Jitter Buffer Min	0~160ms	30
05	G.711 Jitter Buffer Average	0~160ms	60
06	G.711 Jitter Buffer Max	0~160ms	120
07	Number of G.729 Audio Frames	1~6 1 = 10ms 2 = 20ms 3 = 30ms 4 = 40ms 5 = 50ms 6 = 60ms	3
08	G.729 Voice Activity Detection Mode	0 = Disable 1 = Enable	0
09	G.729 Jitter Buffer Min	0~270ms	30
10	G.729 Jitter Buffer Average	0~270ms	60
11	G.729 Jitter Buffer Max	0~270ms	120

Input Data

Item No.	Item	Input Data	Default
12	Number of G.723 Audio Frames	1~2 1 = 30ms 2 = 60ms	1
13	G.723 Voice Activity Detection Mode	0 = Disable 1 = Enable	0
14	G.723 Jitter Buffer Min	0~270ms	30
15	G.723 Jitter Buffer Average	0~270ms	60
16	G.723 Jitter Buffer Max	0~270ms	120
17	Jitter Buffer Mode	1 = Static 2 = Adaptive during silence 3 = Adaptive immediate	3
18	Voice Activity Detection Threshold	0~30 (-19dB~ +10dB) 0 = Self adjustment 1 = -19dB (-49dBm) : 20 = 0dB (-30dBm) : 29 = 9dB (-21dBm) 30 = 10dB (-20dBm)	20
19	Idle Noise Level	5000~7000 (-5000dBm~ -7000dBm)	7000
20	Echo Canceller Mode	0 = Disable 1 = Enable	1
21	Signal Limiter Mode	1 = Mode 0 2 = Mode 1 3 = Mode 2 4 = Mode 3 5 = Mode 4 6 = Mode 5	6
22	Echo Canceller NLP Mode	0 = 2 wire and 4 wire 1 = 2 wire only	1
24	Echo Canceller CNG Configuration	0 = Adaptive 1 = Fixed	0

Input Data

Item No.	Item	Input Data	Default
26	TX Gain	0~40 (-14dBm~+14dBm) 0 = -20dBm 1 = -19dBm : 20 = 0dBm : 39 = 19dBm 40 = 20dBm	20
27	RX Gain	0~40 (-14dBm~+14dBm) 0 = -20dBm 1 = -19dBm : 20 = 0dBm : 39 = 19dBm 40 = 20dBm	20
28	Audio Capability Priority	0~3 0 = G.711_PT 1 = G.723_PT 2 = G.729_PT 3 = G.722_PT 4 = G.726 5 = Not Used	0
30	Auto Gain Control	0~5	0
31	DTMF Relay Mode	0 = Disable 1 = RFC2833	0
32	Fax Relay Mode	0 = Disable 1 = Enable 2 = Each port mode	0
33	Number of G.722 Audio Frames	1~4 1 = 10ms 2 = 20ms 3 = 30ms 4 = 40ms	3
34	G.722 Voice Activity Detection Mode	0 = Disabled 1 = Enabled	0
35	G.722 Jitter Buffer (min)	0~160ms	30
36	G.722 Jitter Buffer (Average)	0~160ms	60
37	G.722 Jitter Buffer (max)	0~160ms	120

Input Data

Item No.	Item	Input Data	Default
38	Number of G.726 Audio Frames	1~4 1 = 10ms 2 = 20ms 3 = 30ms 4 = 40ms	3
39	G.726 Voice Activity Detection Mode	0 = Disabled 1 = Enabled	0
40	G.726 Jitter Buffer (min)	0~160ms	30
41	G.726 Jitter Buffer (Average)	0~160ms	60
42	G.726 Jitter Buffer (max)	0~160ms	120
43	--- Not Used ---		
44	--- Not Used ---		
45	--- Not Used ---		
46	--- Not Used ---		
47	--- Not Used ---		
48	--- Not Used ---		

Conditions

None

Feature Cross Reference

- Voice Over Internet Protocol (VoIP)

Program 84 : Hardware Setup for VoIP

84-26 : IPL Basic Setup

Level:
IN

Description

Use **Program 84-26 : IPL Basic Setup** to set the IP address of IPL and the port.

Index 1

Slot Number	1
-------------	---

VoIP GW Number	01~08
----------------	-------

Item No.	Item	Input Data	Default
01	IP Address	xxx.xxx.xxx.xxx	Slot 1 = 172.16.0.20 ⋮ Slot 4 = 172.16.0.44 VoIP GW Number 1~8: 172.16.0.20~172.16.16.0.27
02	RTP Port Number <i>Only even numbered RTP ports are supported.</i>	0~65534	VoIP GW1 = 10020 VoIP GW2 = 10052 VoIP GW3 = 10084 VoIP GW4 = 10116 VoIP GW5 = 10148 VoIP GW6 = 10180 VoIP GW7 = 10212 VoIP GW8 = 10244
03	RTCP Port Number (RTP Port Number +1)	0~65534	VoIP GW1 = 10021 VoIP GW2 = 10053 VoIP GW3 = 10085 VoIP GW4 = 10117 VoIP GW5 = 10149 VoIP GW6 = 10181 VoIP GW7 = 10213 VoIP GW8 = 10245

Conditions

None

Feature Cross Reference

- Voice Over Internet Protocol (VoIP)

Program 84 : Hardware Setup for VoIP

84-27 : IPL Basic Setup

Level:
IN

Description

Use **Program 84-27 : IPL Basic Setup** to set the DTMF Relay and the SRTP mode of the IPL.

Index 1

Slot Number	1
-------------	---

Input Data

Item No.	Item	Input Data	Default
01	DTMF Relay Setup	0 = DTMF Relay disabled 1 = In-Band DTMF Relay -Do not report to host processor 2 = Out of Band Relay - Do not pass tones as voice	2
02	Setup CODEC Mode Default means the system uses another CODEC except G.723. Mode 1 means the system uses all CODECs, but the limitation of the total number of available DSP will be applied.	0 = Default 1 = Mode 1 (G.723)	0
03	SRTP Mode Setup	0 = Disable 1 = Enable	0
04	SRTP Mode Select	0 = Mode1	0
06	H.245 Port Number	0~65535	10100
07	Preparation Completion Response Port Number	0~65535	4000

Conditions

None

Feature Cross Reference

- Voice Over Internet Protocol (VoIP)

Program 84 : Hardware Setup for VoIP

84-28 : DT700 Multiline Firmware Name Setup

Level:
IN

Description

Use **Program 84-28 : DT700 Multiline Firmware Name Setup** to set the firmware name to download for the IP Phone.

Index 1

Terminal Type	1 = ITL-**E-1D/IP-*E-1 2 = ITL-**D-1D/ITL-24BT1D/ITL-24PA-1D 3 = ITL-320C-1
---------------	---

Input Data

Item No.	Item	Input Data	Default
01	Firmware Directory	Maximum 64 characters	No Setting
02	Firmware File Name	Maximum 30 characters	No Setting

Conditions

None

Feature Cross Reference

- Voice Over Internet Protocol (VoIP)

Program 84 : Hardware Setup for VoIP

84-29 : SIP-MLT CODEC Information Fixed Mode Setup

Level:
IN

Description

Use **Program 84-29 : SIP-MLT CODEC Information Fixed Mode Setup** to set the CODEC data of the SIP-MLT when it uses Multicast.

Index 1

Type	1 = Type 1 (Multicast) 2 = Type 2 (reserved) 3 = Type 3 (reserved) 4 = Type 4 (reserved) 5 = Type 5 (reserved)
------	--

Input Data

Item No.	Item	Input Data	Default
01	Audio Capability	1 = G.711 A-law 2 = G.711 μ -law 3 = G.729 4 = G.723 5 = G.722	2
02	Number of Audio Frames	1~6 1 = 10ms 2 = 20ms 3 = 30ms 4 = 40ms 5 = 50ms 6 = 60ms	2

Conditions

- When using G.711, PRG 84-29-02 only 10ms, 20ms, 30ms and 40ms are used.

Feature Cross Reference

None

Program 84 : Hardware Setup for VoIP

84-30 : PVA-CCIS over IP CODEC Setup

Level:
IN

Description

Use **Program 84-30 : PVA-CCIS over IP CODEC Setup** to set the CODEC information of the PVA-CCIS over IP.

Input Data

Item No.	Item	Input Data	Default
01	Number of G.711 Audio Frames	1~2 1 = 20ms 2 = 30ms	2
02	G.711 Type	0 = A-law 1 = μ -law	1
03	G.711 Voice Activity Detection Mode	0 = Disable 1 = Enable	0
04	G.711 Jitter Buffer Min	0~160ms	30
05	G.711 Jitter Buffer Average	0~160ms	60
06	G.711 Jitter Buffer Max	0~160ms	120
07	Number of G.729 Audio Frames	1~3 1 = 20ms 2 = 30ms 3 = 40ms	2
08	G.729 Voice Activity Detection Mode	0 = Disable 1 = Enable	0
09	G.729 Jitter Buffer Min	0~500ms	30
10	G.729 Jitter Buffer Average	0~500ms	60
11	G.729 Jitter Buffer Max	0~500ms	120
12	Number of G.723 Audio Frames	1~2 1 = 30ms 2 = 60ms	1
13	G.723 Voice Activity Detection Mode	0 = Disable 1 = Enable	0

Input Data

Item No.	Item	Input Data	Default
14	G.723 Jitter Buffer Min	0~500ms	30
15	G.723 Jitter Buffer Average	0~500ms	60
16	G.723 Jitter Buffer Max	0~500ms	120
17	TX Gain	0~40 (-14dBm~+14dBm) 0 = -20dBm 1 = -19dBm : 20 = 0dBm : 39 = 19dBm 40 = 20dBm	20
18	RX Gain	0~40 (-14dBm~+14dBm) 0 = -20dBm 1 = -19dBm : 20 = 0dBm : 39 = 19dBm 40 = 20dBm	20
19	1st Priority of Audio Capability	0 = G.711_PT	0
20	2nd Priority of Audio Capability	1 = G.723_PT 2 = G.729_PT	1
21	DTMF Relay Mode	0 = Disable 1 = Inbound (RFC2833) 2 = Outbound (H.245)	0
22	Jitter Buffer Mode	1 = Static 2 = Adaptive during silence 3 = Adaptive immediate	3
23	Voice Activity Detection Threshold	0~30 (-19dB~ +10dB) 0 = Self adjustment 1 = -19dB (-49dBm) : 20 = 0dB (-30dBm) : 29 = 9dB (-21dBm) 30 = 10dB (-20dBm)	20
24	Echo Canceller Mode	0 = Disable 1 = Enable	1
25	Echo Canceller NLP Mode	0 = Disable 1 = Enable	1

Input Data

Item No.	Item	Input Data	Default
26	LDP Check Sum Mode	0 = Disable 1 = Enable	1

Conditions

- PVA-CCIS CODEC changes require a reset of the CD-PVAA blade.

Feature Cross Reference

None

Program 85 : HUB(8) LAN Setup

85-01 : HUB(8) LAN Setup

Level:
IN

Program

85

Description

Use Program 85-01 : HUB(8) LAN Setup to define the LAN setup for each slot.

(V2500 or higher required)

Input Data

Hub Slot	1~24
Hub Port	0~8

Item No.	Item	Input Data	Default	Description
01	Auto Negotiation	0 = Enable 1 = Disable	0	When enabled, Link Speed, Duplex and MDI/MDIX setting are negotiated with the other connected device.
02	Link Speed	0 = 10Mbps 1 = 100Mbps	1	85-01-01 – Disable
03	Half Duplex/Full Duplex	0 = Half 1 = Full	1	85-01-01 – Disable
04	Auto MDI/MDIX	0 = MDIX 1 = MDI 2 = Auto	2	When 85-01-01 is enabled, Auto MDI/MDIX will function. Auto MDI/MDIX (Media Dependent Interface / Media Dependent Interface Cross-over) enables a switch port to sense the appropriate transmit/receive pairs of an Ethernet cable.

Item No.	Item	Input Data	Default	Description
05	Back Pressure, Half-Duplex	0 = Disable 1 = Enable	0	85-01-01 – Disable, 85-01-03 – Half-Duplex When enabled, a switch applies back pressure to a half-duplex ingress port while an output queue is congested.
06	Flow Control, Full-Duplex	0 = Disable 1 = Enable	0	Full Duplex – 802.3x 85-01-01 – Disable 85-01-03 – Full-Duplex When enabled, a switch applies flow control to a full-duplex ingress port while an output queue is congested.

Conditions

None

Feature Cross Reference

- Voice Over Internet Protocol (VoIP)

Program 85 : HUB(8) LAN Setup

85-02 : HUB(8) VLAN Setup

Level:
IN

Description

Use **Program 85-02 : HUB(8) VLAN Setup** to define the VLAN setup for each HUB(8) blade. The CHS1U-US can support up to 16, 802.1q VLANs (numbered 1 ~ 16). Program Block 85-02 assigns supported VLAN IDs, with a range of 1 ~ 4095.

At default, 802.1q support is disabled. If Program Block 85-02-01 is set to ENABLE, 802.1q VLAN tagging is supported.

85-02-02 through 85-02-09 establish the default VLAN for ports 1 ~ 8 of the HUB(8).

(V2500 or higher required)

Input Data

Hub Slot	1~24
----------	------

Item No.	Item	Input Data	Default
01	VLAN Mode	0 = Disable 1 = Enable	0
02	Port 1 VLAN ID	1~4095	1
03	Port 2 VLAN ID	1~4095	1
04	Port 3 VLAN ID	1~4095	1
05	Port 4 VLAN ID	1~4095	1
06	Port 5 VLAN ID	1~4095	1
07	Port 6 VLAN ID	1~4095	1
08	Port 7 VLAN ID	1~4095	1
09	Port 8 VLAN ID	1~4095	1

Conditions

None

Feature Cross Reference

- Voice Over Internet Protocol (VoIP)

Program 85 : HUB(8) LAN Setup

85-03 : Priority Setup

Level:
IN

Description

Use **Program 85-03 : Priority Setup** to establish the queuing prioritization rules for the low and high priority queues. Each port has a low and a high priority queue for both ingress and an egress. These queues serve to buffer packets during times of heavy network traffic. The HUB(8) supports 802.1q/p layer 2 Quality of Service.

(V2500 or higher required)

Input Data

Hub Slot	1~24
Hub Port	0~8

Item No.	Item	Input Data	Default	Description
01	Default Priority	0 = Disable 2 = Low 3 = High	0	Assigns untagged frames to either the Low or the High queue, and tags them with a priority assigned in Program 85-03-03 (High) or Program 85-03-04 (Low).
02	RX High	0~7	1	RX High establishes the minimum threshold for frames designated for the high priority queues.
03	TX High	0~7	7	When Program 85-03-01 is set to High , untagged frames are marked with this priority setting. Previously tagged frames are unchanged.
04	TX Low	0~7	0	When Program 85-03-01 is set to Low , untagged frames are marked with this priority setting. Previously tagged frames are unchanged.

Conditions

None

Feature Cross Reference

- Voice Over Internet Protocol (VoIP)

Program 85 : HUB(8) LAN Setup

85-04 : Port Mirroring Setup

Level:
IN

Description

Use **Program 85-04 : Port Mirroring Setup** to define the port mirroring for each HUB(8) blade. This permits traffic from one port to be simultaneously transmitted to a second port. Port mirroring is typically used for debugging with a protocol analyzer.

(V2500 or higher required)

Input Data

Hub Slot	1~24
----------	------

Item No.	Item	Input Data	Default	Description
01	Port Mirroring	0 = Disable 1 = Enable	0	
02	Source Port	1~8	1	Set to the port to be monitored.
03	Target Port	1~8	1	Set to the port where the protocol analyzer is connected.

Conditions

- Set to the port where the protocol analyzer is connected.

Feature Cross Reference

- Voice Over Internet Protocol (VoIP)

Program 85 : HUB(8) LAN Setup

85-05 : HUB(8) VLAN Group Settings

Level:
IN

Description

Use **Program 85-05 : HUB(8) VLAN Group Settings** to define the VLAN group setup for each HUB(8) blade.

(V2500 or higher required)

Input Data

Slot	1~24
VLAN Group	00~15

Item No.	Item	Input Data	Default	Description
01	VLAN ID	0~4095	0	802.1q VLAN ID
02	Port	00000000~11111111	00000000	Represents the eight physical ports of the HUB(8), numbered from left to right as 8 to 1. Setting a port to 1 enables the port to allow traffic from the VLAN ID specified in Program 85-05-01.
03	Tag Egress Retention	00000000~11111111	00000000	Represents the eight physical ports of the HUB(8), numbered from left to right as 8 to 1. At the point of egress, should VLAN tags be retained or removed? (Many Ethernet devices do not process VLAN tagged packets.) Setting a port to 1 permits VLAN tags to be retained.

Conditions

None

Feature Cross Reference

- Voice Over Internet Protocol (VoIP)

THIS PAGE INTENTIONALLY LEFT BLANK

Program 90 : Maintenance Program

90-01 : Installation Date

Level:
IN

Description

Use Program 90-01 : Installation Date to define the installation date of the system.

Input Data

Item No.	Item	Input Data	Default
01	Year	00~99	00 (No Setting)
02	Month	01~12	00 (No Setting)
03	Day	01~31	00 (No Setting)

Conditions

None

Feature Cross Reference

None

Program

90

Program 90 : Maintenance Program

90-02 : Programming Password Setup

Level:
IN

Description

Use **Program 90-02 : Programming Password Setup** to set the system passwords. For password entry, the system allows eight users to be defined. Each user can have a:

- Unique alphanumeric name (up to 10 alphanumeric characters)
- Password entry of up to eight digits (using 0~9, # and *)
- Password level

The IN level password is used by the System Installer for system programming. The SA or SB level password cannot access the IN level programs. The reverse type (white on black) just beneath the Description heading is the program access level. You can only use the program if your access level meets or exceeds the level the program requires. (SA level password can access to SA or SB programs, and SB level password can access to SB programs only.)

CAUTION

Before changing your numbering plan, use the PC Programming or WebPro Programming to make a backup copy of your system data.

Input Data

User Number	1~8
-------------	-----

Item No.	Item	Input Data
01	User Name	Maximum 10 characters
02	Password	Up to 8 digits
03	User Level	0 = Prohibited User 1 = MF (Manufacturer Level) 2 = IN (Installer Level) 3 = SA (System Administrator Level 1) 4 = SB (System Administrator Level 2) 5 = UA (User Programming Level 1)

Default

User No.	User Name	Password	Level	Level Description
1	necii	47544	1 (MF)	Manufacturer Level - Access to all system programs.
2	tech	12345678	2 (IN)	Installer Level - Access to all IN level programs.
3	ADMIN1	0000	3 (SA)	System Administrator Level 1 - Restricted Access
4	ADMIN2	9999	4 (SB)	System Administrator Level 2 - More Restricted Access
5	USER1	1111	5 (UA)	User Programming Level 1
6			5 (UA)	User Programming Level 1
7			5 (UA)	User Programming Level 1
8			5 (UA)	User Programming Level 1

Conditions

- More than one extension can be in the programming mode.

Feature Cross Reference

None

Program 90 : Maintenance Program

90-03 : Save Data

Level:
SA

Description

(This program is available only via telephone programming and not through PC Programming).

Use **Program 90-03 : Save Data** to save the programmed data on the USB Flash Drive. This program should be used after changing the programmed data.

Input Data

Item No.	Item	Input Data
01	Save Data	Dial 1 + press Transfer (Press Transfer to cancel.)

Conditions

- When reloading a customer database, the system must be reset (either using Program 90-08 or power down/power up) before all uploaded programming takes affect.

Feature Cross Reference

None

Program 90 : Maintenance Program

90-04 : Load Data

Level:
SA

Description

(This program is available only via telephone programming and not through PC Programming).

Use **Program 90-04 : Load Data** to load the system data from the inserted USB Flash Drive to the SRAM and Flash ROM in the system.

Input Data

Item No.	Item	Input Data
01	Load Data	Dial 1+ press Transfer (Press Transfer to cancel)

Conditions

- After uploading the programming, reset the system and wait a few minutes for the system to reset completely before accessing any line or special system feature. Otherwise, some unusual LED indications may be experienced.

Feature Cross Reference

None

Program 90 : Maintenance Program

90-05 : Slot Control

Level:
IN

Description

(This program is available only via telephone programming and not through PC Programming).

Use **Program 90-05 : Slot Control** to reset or delete (uninstall) blades (slots 1~24).

Delete allows you to completely uninstall the blade. You should do this if you want to remove a blade and plug it into a different slot and still retain the port assignments. If a different type of interface blade is being installed in a slot previously used (e.g., changing from a LCA to an DLCA blade), the slot should be deleted (option 1) first before installing the new interface blade.

Reset allows you to send a reset code.

Input Data

Menu Number	1 = Delete 2 = Reset 3 = Set Busy Out 4 = Reset Busy Out
-------------	---

Item No.	Item	Input Data
01	Slot Control	Slot Number (1~24)

Conditions

- When you delete or reset a blade, you must first remove it from its slot then run Program 90-05. When reusing the slot for another blade, you must plug the blade in or reset the system before the system can use the slot again.
- When you delete or reset a blade, all related programming in Program 10-03-01 is set back to default.

Feature Cross Reference

None

Program 90 : Maintenance Program

90-06 : Trunk Control

Level:
SA

Description

(This program is available only via telephone programming and not through PC Programming).

Use **Program 90-06 : Trunk Control** for trunk maintenance. Busy Out lets you block a blade from placing outgoing calls (just like placing the blade switch down). Once busied out, none of the ports on the blade can be used for new calls. Existing calls, however, are not torn down.

Input Data

Menu Number	0 = Set Busy Out 1 = Reset Busy Out (idle)
-------------	---

Item No.	Item	Input Data
01	Trunk Control	Trunk Port Number: 001~200

Conditions

None

Feature Cross Reference

None

Program 90 : Maintenance Program

90-07 : Station Control

Level:
SA

Description

(This program is available only via telephone programming and not through PC Programming).

Use **Program 90-07 : Station Control** for extension maintenance.

Input Data

Menu Number	1 = Hardware Reset 2 = Software Reset
-------------	--

Item No.	Item	Input Data
01	Extension Control	Extension Number (up to eight digits)

Conditions

None

Feature Cross Reference

None

Program 90 : Maintenance Program

90-08 : System Reset

Level:**IN**

Description

(This program is available only via telephone programming and not through PC Programming).

Use **Program 90-08 : System Reset** to perform a system reset.

Input Data

Item No.	Item	Input Data
01	System Reset	Dial 1 + press Transfer (Press Transfer key to cancel)

Conditions

- After restoring a customer database, the system must be reset using Program 90-08 or by powering down/powering up before all the restored programming takes affect.

Feature Cross Reference

None

Program 90 : Maintenance Program

90-09 : Automatic System Reset Time Setup

Level:

IN

Description

Use **Program 90-09 : Automatic System Reset Time Setup** to define the time for the system to automatically reset.

Input Data

Item No.	Item	Input Data	Default
01	Month	00~12 <i>(Note 1)</i>	00
02	Day	00~31 <i>(Note 2)</i>	00
03	Hour	00~23	00
04	Minute	00~59	00

Note 1 If the Month is set to 00 and Day is set, the system is automatically reset every month on the predefined day.

Note 2 If the Day is set to 00 and the Time (Hour and Minute) is set, the system automatically resets every day at the predefined time.

Conditions

None

Feature Cross Reference

None

Program 90 : Maintenance Program

90-10 : System Alarm Setup

Level:

IN

Description

Use **Program 90-10 : System Alarm Setup** to assign a status to system alarms. You can designate an alarm as Major or Minor. This program also assigns whether or not the alarm information is reported to the predefined destination.

Input Data

Alarm Number	001~100
--------------	---------

Item No.	Item	Input Data
01	Alarm Type	0 = Not Set 1 = Major Alarm 2 = Minor Alarm
02	Report	0 = Not Report (No autodial) 1 = Report (autodial)

Table 2-20 Description of Alarm

Alarm No.	Type	Report	Name	Content of Alarm	Cause	Action	Recovery	Alarm Status
1	2	0	PKG Initialize Error.	1. The PKG failed to initialize. 2. The PKG did not start normally.	1. PKG not inserted firmly. 2. PKG was removed, but not reinserted firmly. 3. Old PKG data still reported due to no initialization.	1. Insert PKG firmly. 2. Insert PKG firmly. 3. Delete slot information in PRG 90-05 and insert the PKG again.	During initialization, the PKG is recognized.	ERR REC
2	2	0	PKG Mounting Error	The unit did not step on a regular procedure and it was pulled out. Or, it is not normally inserted.	1. The package is not completely inserted. 2. The package is out of order.	1. Insert the package firmly. 2. Try again after initializing the system data once when LED doesn't blink normally. 3. Exchange packages.	When unit is reconfirmed, the error is recovered.	ERR REC

Table 2-20 Description of Alarm (Continued)

Alarm No.	Type	Report	Name	Content of Alarm	Cause	Action	Recovery	Alarm Status
3	2	0	Connection fault between CD-CP00-US and other PKGs.	The error occurred when communicating with the package. When the package is broken, it recognizes it as a communication fault.	<ol style="list-style-type: none"> 1. The unit is not completely installed. 2. The power-supply voltage of the system is outside ratings. 3. The equipment that generates the noise in the same power supply system as the power supply origin of the system is connected, and it malfunctions because of the power supply noise. 4. The equipment to which it is adjacent to of a main device, and has put out the radiation noise exists, and it malfunctions because of the radiation noise. 5. The chassis is not properly grounded. 	<ol style="list-style-type: none"> 1. Insert the unit firmly. 2. The power-supply voltage must use another power supply when is in the range of ratings or measuring with the voltmeter, and deviating from the rated range. 3. Use the power supply besides the equipment with the possibility of the noise source. 4. Separate as much as possible and use a main device from the equipment by which you seem may generate the radiation noise. 5. Ground the chassis correctly. 	When unit is confirmed, the error is recovered.	ERR REC
4	2	0	PKG S/W Download Error	The unit program could not be downloaded normally. The unit could not be started normally.	<ol style="list-style-type: none"> 1. The package software is not stored in the downloaded USB memory. 2. The stored package software is illegal. Package information that was installed before remains. 	<ol style="list-style-type: none"> 1. Delete slot information that corresponds by PRG90-05-01 to delete package information that was installed before. 2. There is a possibility that the unit program is broken though an external factor of the noise etc. 3. load into the USB memory and try again when you back up the unit program. 4. Check with maker on uncertain points. 	Please exchange units, though it is likely to restore by mounting the unit again. When the unit program is normally downloaded, the error is recovered.	ERR REC
5	1	0	Cooling fan error	The cooling fan does not work normally.	<ol style="list-style-type: none"> 1. The cooling fan has stopped working. 2. The cooling fan has come off. 	<ol style="list-style-type: none"> 1. Confirm the cooling fan is turning. 2. Verify the cooling fan mounting. 	Replace the cooling fan if it is defective.	

Table 2-20 Description of Alarm (Continued)

Alarm No.	Type	Report	Name	Content of Alarm	Cause	Action	Recovery	Alarm Status
6	0	0	Blocking	The link of terminals connected with the ESI package came off.	<ol style="list-style-type: none"> 1. Terminal breakdown. 2. Faulty wiring and wiring termination. 3. External noise. 4. ESI package Breakdown. 	<ol style="list-style-type: none"> 1. Confirm the terminal connected with same ESI. If they work normally, confirm the breakdown or the wiring for the terminal. 2. Exchange the terminal that doesn't work and the working terminal, and confirm it's working. An external factor of the noise etc. is thought. 3. Confirm wiring and the installation, etc. 4. Check with manufacturer if the problem occurs again. 	The error is recovered when connecting or exchanging it.	ERR REC
7	1	0	Power failure	The supply of the commercial power stopped.	<ol style="list-style-type: none"> 1. The power cable came off. 2. Power failure 3. The power supply broke down. 	<ol style="list-style-type: none"> 1. Confirm the power supply outlet when the commercial power has not stopped. 2. Check with the manufacturer if the problem occurs again. 	When the commercial power is restored, the error is recovered.	ERR REC
8	1	0	RAM Backup Battery Error	RAM backup battery on the CD-CP00-US blade is unplugged or defective.		Check the battery connector. If it is connected correctly, replace the battery.	The error is recovered once the battery is replaced.	ERR REC
9	--- Reserved ---							
10	0	0	ISDN Link Error	Layer1 link of ISDN lines came off.	<ol style="list-style-type: none"> 1. Check connection between main device and ISDN line. 2. DSU breakdown 3. The setting of PRG10-03 does not correspond to an actual line. 	<ol style="list-style-type: none"> 1. Confirm the data of PRG10-03. 2. Confirm wiring and installation of DSU. 3. Check with the manufacturer if the problem occurs again. 	When the connection returns normally, the error is recovered.	ERR REC
11	0	0	CTI Link Error	The link with the CTI server came off.	<ol style="list-style-type: none"> 1. LAN cable defective. 2. Connected HUB broken. 3. The CTI server doesn't start normally. 	<ol style="list-style-type: none"> 1. Confirm the CTI server, wiring, and the connection. 2. Check with manufacturer if the problem occurs again. 	When the connection returns normally, the error is recovered.	ERR REC
12	0	0	ACD MIS Link Error	The link with ACD MIS client PC came off.	<ol style="list-style-type: none"> 1. LAN cable defective. 2. Connected HUB broken. 3. The CTI server doesn't start normally. 	<ol style="list-style-type: none"> 1. Confirm ACD MIS client PC and connected part. 2. Check with manufacturer if the problem occurs again. 	When the connection returns normally, the error is recovered.	ERR REC

Table 2-20 Description of Alarm (Continued)

Alarm No.	Type	Report	Name	Content of Alarm	Cause	Action	Recovery	Alarm Status
13	0	0	Charge Management Link Error	The link with the charge management device came off.	<ol style="list-style-type: none"> 1. Wiring problem in connecting main device with charge management device. 2. PC Problem. 	<ol style="list-style-type: none"> 1. Confirm that there is no problem in wiring to connect a main device with the charge management device. (Whether ping passes for LAN connection is confirmed.) 2. Restart the charge management software. 3. Reboot PC, and start charge management software. 	When the connection returns normally, the error is recovered.	ERR REC
14	0	0	LAN Link Error	The link with LAN on CD-CP00-US came off.	<ol style="list-style-type: none"> 1. LAN cable defective. 2. Connected HUB broken. 3. Defective CD-CP00-US. 	Confirm the operation of LAN connector, LAN cable, and HUB again.	When the connection returns normally, the error is recovered.	ERR REC
15	0	0	Network Keep Alive	<ol style="list-style-type: none"> 1. The network connection has been cut. 2. Network Keep Alive restoration. 3. Response notification on network Keep Alive. 	<ol style="list-style-type: none"> 1. LAN cable is defective. 2. Net side trouble. 3. Packet blocked by firewall. 4. Repetition of IP address. 	<ol style="list-style-type: none"> 1. Confirm that the defect is on the Network side. 2. Confirm the settings of HUB and the router, etc. 	When the connection returns normally, the error is recovered.	ERR REC WAR
16	0	0	SMDR Link					
17	1	0	Denial of service	The system received an illegal packet.	Service outage (DOS)	Confirm that the defect is on the Network side.		WAR
18~28	--- Reserved ---							
29	0	0	Charge Management Buffer full	The temporary buffer for the charge management in main device overflowed, and a part of unoutput charge data disappeared because it could not output the charge management data.	<ol style="list-style-type: none"> 1. The charge data is printed and not deleted at the simple charge management. 2. The charge data is not output to PC for the charge management software. 	<ol style="list-style-type: none"> 1. Print and delete the charge data at the simple charge management. 2. Connect the charge management software for the charge management software and output the charge data. 	When the output is restarted, the error is recovered. However, the charge management data after the error occurs is not recorded.	ERR REC
30	2	0	SMDR Buffer full	The temporary buffer for SMDR in main device overflowed, and a part of unoutput SMDR data disappeared because it could not output SMDR data.	<ol style="list-style-type: none"> 1. Problem of wiring to connect main device with PC. 2. PC Problem. 	<ol style="list-style-type: none"> 1. Confirm whether there is problem in wiring to connect a main device with PC. 2. Execute the reactivation of PC. 	When the output is restarted, the error is recovered. However, the SMDR data after the error occurs is not recorded.	ERR REC
31~34	--- Reserved ---							

Table 2-20 Description of Alarm (Continued)

Alarm No.	Type	Report	Name	Content of Alarm	Cause	Action	Recovery	Alarm Status
35	0	0	CS Blocking	The link of the CSIU and CS came off.	1. Outgoing noise. 2. Method of setting up CS. 3. Wiring to connect CSIU unit with CS. 4. Hard defect of CS. 5. Hard defect of CSIU.	Confirm the following when it happens frequently during operation. 1. Confirm CS is normally connected. 2. Confirm the wiring between CSIU-CS is normal. 3. Exchange CS. 4. Exchange CSIU.	The error is recovered when reconnecting or exchanging it.	ERR REC
36	0	0	CS error notification 1	CS detected the problem occurring in the air synchronous signal between CS-CSIU, BBIC reset was executed, and it was restored automatically.	1. Outgoing noise. 2. Method of setting up CS. 3. Wiring to connect CSIU unit with CS. 4. Hard defect of CS. 5. Hard defect of CSIU.	Confirm the following when it happens frequently during operation. 1. Confirm CS is normally connected. 2. Confirm the wiring between CSIU-CS is normal. 3. Exchange CS. 4. Exchange CSIU.	This error has been recovered when it is notified.	ERR REC
37	0	0	CS transmission error.	Because CS had not returned the response to the control signal from a main device longer than the fixed time, it was restored automatically specifying reset to concerned CS with a main device.	1. Outgoing noise. 2. Method of setting up CS. 3. Wiring to connect CSIU unit with CS. 4. Hard defect of CS. 5. Hard defect of CSIU.	Confirm the following when it happens frequently during operation. 1. Confirm CS is normally connected. 2. Confirm the wiring between CSIU-CS is normal. 3. Exchange CS. 4. Exchange CSIU.	This error has been recovered when it is notified.	ERR REC
38	0	0	CSIU Dch Error*	It was restored automatically specifying reset to concerned CS with a main device because a main device had detected the control signal from a main device not normally reaching CS.	1. Outgoing noise. 2. Method of setting up CS. 3. Wiring to connect CSIU unit with CS. 4. Hard defect of CS. 5. Hard defect of CSIU.	Confirm the following when it happens frequently during operation. 1. Confirm CS is normally connected. 2. Confirm the wiring between CSIU-CS is normal. 3. Exchange CS. 4. Exchange CSIU.	This error has been recovered when it is notified.	ERR REC
39	0	0	CSIU transmission error.	This alarm is integrated into Communication fault between the CD-CP00-US and other PKG, and it is not used in SV8100.				
40	0	0	CS error notification 2.	CS detected the factor that the noise is generated between CS-PS, BBIC reset was executed, and it was restored automatically.	1. Outgoing noise. 2. Method of setting up CS. 3. Wiring to connect CSIU unit with CS. 4. Hard defect of CS. 5. Hard defect of CSIU.	Confirm the following when it happens frequently during operation. 1. Confirm CS is normally connected. 2. Confirm the wiring between CSIU-CS is normal. 3. Exchange CS. 4. Exchange CSIU.	This error has been recovered when it is notified.	ERR REC
41~49	--- Reserved ---							
50	1	0	System Start Notification	The system started.	The system was started.	No action needed.		

Table 2-20 Description of Alarm (Continued)

Alarm No.	Type	Report	Name	Content of Alarm	Cause	Action	Recovery	Alarm Status	
51	0	0	System Data change	CD-CP00-US Upgrade is performed or Programming change is made.		No action needed.			
52	0	0	--- Reserved ---						
53	0	0	--- Reserved ---						
54	2	0	License Management Table Full	A new TCP/IP terminal and the DSP board were not able to be added to the application license management table. • The license management table is registering full.	Maximum 512 license information on the TCP/IP terminal is registered, and a new terminal cannot be registered.	Delete license information on an unnecessary TCP/IP terminal with PRG 90-44.		WAR	
55	2	0	Regular maintenance exchange notification.	The regular maintenance exchange day has passed.	• The regular maintenance exchange day that had been set with PRG 90-51 exceeded it.	Do the maintenance exchanges of pertinent parts, and set the next regular maintenance exchange day with PRG 90-51.	The excess on the regular maintenance exchange day is canceled by changing PRG 90-51 or when the function is invalidated, the error is recovered.	ERR REC	
56~59	--- Reserved ---								
60	2	0	SIP Registration Error Notification.	1. The registration of the SIP trunk to the SIP server failed. 2. The registration of the SIP trunk to the SIP server failed in the authentication. 3. There is no response from the SIP server to the SIP registration request.	1. The system data setting is wrong. 2. The router setting is wrong. 3. LAN link error . 4. Net side trouble.	1. Confirm the following system data setting -- PRG 10-12, 10-28, 10-29, 10-30, and 10-36. 2. Confirm the setting of routers. 3. Confirm whether abnormality occurs on the net side. 4. Confirm the authentication system data setting 5. Confirm wiring and the system data setting. Inquire on uncertain points of the maker.	The error is recovered when normally connecting it.	ERR REC	
61	0	0	SIP extension trouble information.	1. Failed registration of the SIP extension terminal. 2. The SIP extension terminal DSP was not acquired: • At registration of SIP extension terminal to SV8100. • When you cannot acquire the DSP resource when it is sent.	1. The registered port is used by other extension. 2. The license is insufficient. 3. DSP of VoIPDB not acquired.	1. Confirm wiring and system data setting. 2. Confirm whether each equipment such as access points works normally.		ERR REC	

Table 2-20 Description of Alarm (Continued)

Alarm No.	Type	Report	Name	Content of Alarm	Cause	Action	Recovery	Alarm Status
62	0	0	DtermIP trouble information.	The error occurred by the DtermIP relation. <ul style="list-style-type: none"> • When the error occurs while communicating with VoIPU or DtermIP. • When it becomes impossible to do the communication between SV8100 and DtermIP • When failing in the acquisition of DSP. 	<ol style="list-style-type: none"> 1. The packet loss occurred on the network or the wiring cutting occurred. 2. DSP of VoIP not acquired. 	Confirm whether each equipment such as wirings and HUB is normal.		ERR REC
63	0	0	SIP-MLT trouble information.	<ol style="list-style-type: none"> 1. The trouble occurred in the SIP-MLT relation. 2. The DSP resource could not be acquired at incoming/outgoing. 3. The negotiation with VoIPDB failed. 	<ol style="list-style-type: none"> 1. The packet loss occurred on the network or the wiring cutting occurred. 2. DSP of VoIP not acquired. 	Confirm whether each equipment such as wirings and HUB is normal.		WAR
64	1	0	VoIPDB LAN Link Error.	The link of LAN of VoIPDB came off.	<ol style="list-style-type: none"> 1. LAN cable defective. 2. Connected HUB broken. 3. Defective CD-CP00-US. 	<ol style="list-style-type: none"> 1. Confirm LAN connector and wiring. 2. Check with maker on uncertain points. 	When the connection returns normally, the error is recovered.	ERR REC
65	0	0	VoIPDB trouble information.	When DSP of VoIPDB notifies Error.	PZ-32IPLA defective.	<ol style="list-style-type: none"> 1. Possibility of defective hardware. 2. Check with maker on uncertain points. 		WAR
66	2	0	SIP extension License Error.	More than the number of licenses to which the SIP extension terminal was turned on at REGISTER.	Wrong number of licenses.	<ol style="list-style-type: none"> 1. Confirm number of licenses for SIP extension terminals. 2. Check with maker on uncertain points. 	When the number of registration of SIP extension terminals falls below the number of licenses.	WAR
67	0	0	SIP illegal packet received.	The system received an illegal packet.	A client or network is in an illegal state.	Check with maker on uncertain points.		INF
68	2	0	VoIP DSP All Busy Alarm	<ol style="list-style-type: none"> 1. Provides alert when all DSP resources are being used. 2. Used to troubleshoot or alerting when upgrade is needed. 	Not enough DSP resources in system.	Install PZ-VMDB with more DSP resources.		
69~79	--- Reserved ---							
80	1	0	NetLink start error.	The error occurred when NetLink started.	Defective CD-CP00-US.	<ol style="list-style-type: none"> 1. Possibility of defective hardware. 2. Check with maker. 		ERR
81	2	0	NetLink call trouble information.	<ol style="list-style-type: none"> 1. The trouble occurred in the NetLink relation. 2. The DSP resource was not acquired at incoming/outgoing. 	PZ-32IPLA DSP not acquired.	<ol style="list-style-type: none"> 1. Confirm wiring and system data settings. 2. Check with maker on uncertain points. 		WAR

Table 2-20 Description of Alarm (Continued)

Alarm No.	Type	Report	Name	Content of Alarm	Cause	Action	Recovery	Alarm Status
82	2	0	NetLink Virtual Slot accommod. error.	The trouble occurred with virtual Slot relation. • It exceeded the upper slot accommodation. • It failed to make a virtual slot.	Exceeds slot accommodations in the NetLink system.	1. Confirm upper slot number. 2. Check with maker on uncertain points.		WAR
83	2	0	NetLink Communication Error.	1. Communication error occurred on NetLink. 2. Checksum error occurred. 3. Index error occurred.	1. The Router setting is wrong. 2. LAN Link error. 3. Net side error.	1. Confirm LAN connector and wiring. 2. Check with maker on uncertain points.		WAR
84	2	0	NetLink License Error	1. License error occurred on NetLink. 2. Expiration date of the license approaches. 3. License nullified.	1. Approaching expiration date of a temporary license. 2. A temporary license was nullified.	1. Confirm license information. 2. Check with maker on uncertain points.		WAR
85	2	0	NetLink node connection refusal.	The connection of Secondary was refused in NetLink. • SystemID overlaps. • SystemID is illegal. • The license is insufficient. • Memory shortage.	1. System ID Repeated. 2. SystemID is illegal. 3. The number of licenses is wrong. 4. Insufficient system memory.	1. Confirm the setting and license information on SystemID. 2. Check with maker on uncertain points.		WAR
86	2	0	Data base replication fail.	Because the versions of DB is different, replication cannot be executed between Primary and Secondary.	The versions of data bases between Primary and Secondary is different.	1. Confirm the version of data bases of Primary and Secondary using PC PRO. 2. Check with maker on uncertain points.		WAR
87	2	0	Data base replication fail.	Because the error occurred in the communication between Primary and Secondary, replication cannot be executed.	LAN link between Primary and Secondary was disconnected.	Confirm LAN link between Primary and Secondary.		WAR
88	2	0	NetLink phase shift.	Operation began as Primary.	Operation began as Primary.	No action is necessary.		INF
89	2	0	NetLink phase shift.	Operation began as Secondary.	Operation began as Secondary.	No action is necessary.		INF
90	2	0	NetLink phase shift.	It shifted to the node search mode.	Shifted to the node search mode.	No action is necessary.		INF
91	2	0	Primary auto-integration.	Primary auto-integration function operated.	Primary auto-integration function operated.	No action is necessary.		INF
92	2	0	Primary compulsion specification.	The Primary compulsion specification function was executed.	Primary compulsion specification function was executed.	No action is necessary.		INF

Table 2-20 Description of Alarm (Continued)

Alarm No.	Type	Report	Name	Content of Alarm	Cause	Action	Recovery	Alarm Status
93	2	0	NetLink node connection detection.	Node connection with NetLink Primary was detected.	Node connection with NetLink Primary was detected.	No action is necessary.		INF
94	2	0	NetLink node secession detection.	Secession of the node detected with NetLink Primary.	Secession of the node detected with NetLink Primary.	No action is necessary.		INF
95	2	0	Data Base replication failure.	Because Secondary is in programming mode, the replication of DB cannot be executed.	Logging in with Secondary in the Web Pro or the PC Pro is possibly the cause.	Log out from Secondary programming mode.		WAR
96	1	0	Data base recovery fail.	Error happened when DataBase recovery operation. Backup/Restore	Lack of resource Memory, protected area, recovery data file corruption are possible reasons for this.	Delete unnecessary file and restore open area, then try operation again.		WAR
97	2	0	DB recovery operation start.	Start Data base recovery operation. Backup/Restore/Delete	Start Data base recovery operation.	No action is necessary.		INF
98	2	0	DB recovery operation finish.	Finish DataBase recovery operation. Backup/Restore/Delete	Finish Data base recovery operation.	No action is necessary.		INF
99	1	0	NetLink configuration error.	The error occurs when the system tries to start NetLink without MEMDB.	PRG51-01-01 is set without PZ-ME50-US.	Install PZ-ME50-US.		WAR
100	--- Reserved ---							

Conditions

- The entire terminal that has an Alarm Display setting can be set at PRG90-50-01.
- System Alarm Type is shown despite the setting done at 90-10-01. If multiple Alarm Display Setting is set, only one highest priority alarm will be shown on a LCD Display.
- The priority level (highest -> lowest): Alarm 55 > Alarm 7 > Alarm 5 > Alarm 30 > Alarm 8 > Alarm 52 > Alarm 29 > Free Demo License Period.

Feature Cross Reference

None

Program 90 : Maintenance Program

90-11 : System Alarm Report

Level:
IN

Description

Use **Program 90-11 : System Alarm Report** to define the details of the system alarm report.

Input Data

Item No.	Item	Input Data	Default
02	Report Method When alarm reports are e-mailed, set this option to 1. E-mail address set in PRG 90-11-08.	0 = No Report 1 = E-mail Address	0
04	--- Not Used ---		
06	SMTP Host Name When alarm reports are e-mailed, set the SMTP name (ex: smtp.yourisp.com). Contact your ISP (internet service provider) for the correct entry if needed.	Up to 255 Characters	No Setting
07	SMTP Host Port Number When alarm reports are e-mailed, set the SMTP host port number. Contact your ISP (internet service provider) for the correct entry if needed.	0~65535	25
08	To E-mail Address When alarm reports are e-mailed, set this e-mail address to where the report should be sent.	Up to 255 Characters	No Setting
09	Reply Address When alarm reports are e-mailed, set the e-mail address where replies should be e-mailed.	Up to 255 Characters	No Setting
10	From Address When alarm reports are e-mailed, set this e-mail address for the station sending the report.	Up to 255 Characters	No Setting
11	DNS Primary Address When alarm reports are e-mailed, set the DNS primary address.	0.0.0.0~255.255.255.255	0.0.0.0
12	DNS Secondary Address When alarm reports are e-mailed, set the DNS secondary address.	0.0.0.0~255.255.255.255	0.0.0.0

Input Data

Item No.	Item	Input Data	Default
13	Customer Name When alarm reports are e-mailed, enter a name to identify the particular system.	Up to 255 Characters	No Setting

Conditions

None

Feature Cross Reference

None

Program 90 : Maintenance Program

90-12 : System Alarm Output

Level:
IN

Description

Use **Program 90-12 : System Alarm Output** to set the options for the alarm report. This program has six separate menu options. Define the output port to be used as the output for system alarm report and set the system alarm options. The system can have up to 50 reports.

Input Data

Item No.	Item	Input Data	Default
01	Output Port Type Indicate the type of connection used for the System Alarms. The baud rate for the COM port should be set in Program 10-21-02.	0 = No Setting 1~3 = -- Reserved -- 4 = CTA/CTU 5 = USB Memory	0
02	CTA Output Destination Extension Number	Up to eight digits	No Setting

Conditions

None

Feature Cross Reference

None

Program 90 : Maintenance Program

90-13 : System Information Output

Level:

IN

Description

Use **Program 90-13 : System Information Output** to define the output port to be used as the system information output. The baud rate for the COM port should be set in Program 10-21-02.

Input Data

Item No.	Item	Input Data	Default
01	Output Port Type Indicate the type of connection used to print the system information.	0 = No Setting 4 = CTA/CTU 5 = USB	0
02	CTA Output Destination Extension Number	Up to eight digits	No Setting
04	Output Destination System ID	0~50	0
05	Output Command	Dial 1+ press Transfer (Press Transfer to cancel.)	–

Conditions

None

Feature Cross Reference

None

Program 90 : Maintenance Program

90-16 : Main Software Information

Level:
IN

Description

Use **Program 90-16 : Main Software Information** to display the main software information on the CD-CP00-US. Main software information can also be viewed outside of system programming by pressing **Feature** and the **3** key on any multiline terminal.

Input Data

Item No.	Item	Input Data	Component
01	Version Number	01.00~99.99	ASCII Code (5 Bytes)
02	Software Release Date	May 22 2002 17:53:46	ASCII Code (20 Bytes)

Conditions

- This Program is Read Only.

Feature Cross Reference

None

Program 90 : Maintenance Program

90-17 : Firmware Information

Level:
IN

Description

Use **Program 90-17 : Firmware Information** to display the firmware versions of the various system blades.

Input Data

Item No.	Item	Display Data	Data Format
01	DSP Firmware Version No.	00.00.00.00~15.15.15.15	BCD Code (2 Byte)

Conditions

None

Feature Cross Reference

None

Program 90 : Maintenance Program

90-19 : Dial Block Release

Level:
SA

Description

When the extension number is entered in **Program 90-19 : Dial Block Release**, the extension is released from the Dial Block restriction.

Input Data

Extension Number	Up to eight digits
------------------	--------------------

Item No.	Item	Input Data
01	Dial Block Release	[Release?] : Dial 1+ press Transfer (Press Transfer to cancel.)

Conditions

None

Feature Cross Reference

- Code Restriction

Program 90 : Maintenance Program

90-20 : Traffic Report Data Setup

Level:
IN

Description

Use **Program 90-20 : Traffic Report Data Setup** to define the details of the traffic report.

Input Data

Item No.	Item	Input Data	Default
01	Call Traffic Output	0 = Not Measured 1 = Measure	0
02	--- Not Used ---		
03	All Line Busy Output	0 = Not Detected 1~256 (Report when the data reaches the defined value)	0
04	DTMF Receiver Busy Output	0 = Not Detected 1~256 (Report when the data reaches the defined value)	0
05	Dial Tone Detector Busy Output	0 = Not Detected 1~256 (Report when the data reaches the defined value)	0
06	Caller ID Receiver Busy Output	0 = Not Detected 1~256 (Report when the data reaches the defined value)	0
07	Voice Mail Channel All Busy Output	0 = Not Detected 1~256 (Report when the data reaches the defined value)	0
08	ACD Operator All Busy Output	0 = Not Detected 1~256 (Report when the data reaches the defined value)	0

Input Data

Item No.	Item	Input Data	Default
09	Attendant Channel All Busy Output	0 = Not Detected 1~256 (Report when the data reaches the defined value)	0
10	Base Station All Busy Output	0 = Not Detected 1~256 (Report when the data reaches the defined value)	0

Conditions

None

Feature Cross Reference

- Traffic Reports

Program 90 : Maintenance Program

90-21 : Traffic Report Output

Level:
IN

Description

Use **Program 90-21 : Traffic Report Output** to define the output port to be used as the traffic report output.

Input Data

Item No.	Item	Input Data	Default
01	Output Port Type	0 = No Setting 3 = LAN	0

Conditions

None

Feature Cross Reference

- Traffic Reports

Program 90 : Maintenance Program

90-22 : Terminal Version information

Level:
IN

Description

Use **Program 90-22 : Terminal Version Information** to determine the hardware and firmware versions. These are read-only commands and cannot be changed.

Input Data

Item No.	Item	Input Data	Default
01	Hardware Version	00~FF	00
02	Firmware Version	00.00~FF.FF	00.00

Conditions

None

Feature Cross Reference

None

Program 90 : Maintenance Program

90-23 : Deleting Registration of IP Telephones

Level:

IN

Description

(This program is available only via telephone programming and not through PC Programming).

Use **Program 90-23 : Deleting Registration of IP Telephones** to delete the registered IP telephone from the system.

Input Data

Extension Number	Up to 8 digits
------------------	----------------

Item No.	Item	Input Data
01	Delete IP Telephone This assignment removes the station number association with the MAC address of the IP station.	[Delete?] : Dial 1 + press Transfer (Press Transfer to cancel.)

Conditions

None

Feature Cross Reference

- Voice Over Internet Protocol (VoIP)

Program 90 : Maintenance Program

90-24 : System Alarm Report Notification Time Setup

Level:

IN

Description

Use **Program 90-24 : System Alarm Report Notification Time Setup** to set the date and time for the alarm report to print.

Input Data

Notification Number	1~12
---------------------	------

Item No.	Item	Input Data	Default
01	Month	00~12	00
02	Day	00~31	00
03	Hour	00~23	00
04	Minute	00~59	00

Conditions

None

Feature Cross Reference

None

Program 90 : Maintenance Program

90-25 : System Alarm Report CC Mail Setup

Level:

IN

Description

Use **Program 90-25 : System Alarm Report CC Mail Setup** to define the mail address to receive the system alarm report CC Mail setup.

Input Data

CC Number	1~5
-----------	-----

Item No.	Item	Input Data	Default
01	CC Mail Address	Up to 255 Characters	No Setting

Conditions

None

Feature Cross Reference

None

Program 90 : Maintenance Program

90-26 : Program Access Level Setup

Level:
IN

Description

Use **Program 90-26 : Program Access Level Setup** to define the password access level required to change a system program.

Input Data

Program Numbers	1001~9201
-----------------	-----------

Item No.	Item	Input Data	Default
01	Maintenance Level	1 = MF Level 2 = IN Level 3 = SA Level 4 = SB Level	Refer to the Level indication for each individual program (located in the upper left corner at the beginning of each program).

Conditions

None

Feature Cross Reference

None

Program 90 : Maintenance Program

90-28 : User Programming Password Setup

Level:

IN

Description

Use **Program 90-28 : User Programming Password Setup** to set the password used to enter the user programming mode.

Input Data

Extension Numbers	Up to eight digits
-------------------	--------------------

Item No.	Item	Input Data	Default
01	Password	Fixed four digits	1111

Conditions

None

Feature Cross Reference

None

Program 90 : Maintenance Program

90-31 : DIM Access over Ethernet

Level:

IN

Description

Use **Program 90-31 : DIM Access over Ethernet** to enable DIM (Diagnostic Information Maintenance) access over the LAN, and to define the user name and password. DIM is a maintenance tool used by engineering to extract trace level information.

Input Data

Item No.	Item	Input Data	Default
01	Access Enabling	0 = Disable 1 = Enable	0 (Disable)
02	Username	20 characters (alphanumeric)	SV8100
03	Password	20 characters (alphanumeric)	12345678

Conditions

None

Feature Cross Reference

None

Program 90 : Maintenance Program

90-34 : Firmware Information

Level:

IN

Description

Use **Program 90-34 : Firmware Information** to list the package type and firmware blades installed in the system.

Input Data

Slot No.	1~24
----------	------

Item No.	Item	Display Data
01	Pkg Name	PKG Name
02	Firmware Version Number	00.00~0F.FF

Conditions

- These Programs are Read Only.

Feature Cross Reference

None

Program 90 : Maintenance Program

90-35 : Wizard Programming Level Setup

Level:
IN

Description

(This program is available only via telephone programming and not through PC Programming).

Use **Program 90-35 : Wizard Programming Level Setup** to set the maintenance level for Wizard Programming.

Input Data

Wizard Number	1~250
---------------	-------

Item No.	Item	Display Data	Default
01	Maintenance Level	0 = All 3 = SB (System Administrator B) 4 = SA (System Administrator A) 5 = IN 6 = MF	0

Conditions

None

Feature Cross Reference

None

Program 90 : Maintenance Program

90-36 : Firmware Update Time Setting

Level:
IN

Description

(This program is available only via telephone programming and not through PC Programming).

Use **Program 90-36 : Firmware Update Time Setting** to define the data for the firmware update feature. This data is available to set for the WebPro/PC Programming FW update feature. A compact flash card must be inserted in the CD-CP00-US for this feature.

The following firmware is available to update with this feature:

- main.bin
- Dspdbu.bin
- dsp.bin

Item No.	Item	Input Data	Default	Description
01	Firmware Update Schedule Time	Year: 0~99	0	Set the time to update the firmware using a compact flash card. Time registration fails if an expired time is registered.
		Month: 0~12	0	
		Day: 00~31	0	
		Hour: 00~23	0	
		Minute: 00~59	0	
02	Update mode	0 = Non Active 1 = Activated	0	Activate the Firmware Update feature. If this setting is 1, new firmware on the compact flash card updates according to the setting at 90-36-01.
03	Update Report	256 characters max.	No Setting	Output a report when the update is executed and saves one copy on the system. If a new update occurs, the new report overwrites the old report. Refer to the Sample Report shown.

Sample Report

Result	Report Display
Update Success	Update is successful with the Update Time.
Update Fail	Update failed. Drive A (Compact Flash) was not available.
Update Fail	Update failed. The file, main.up, does not exist on drive A.
Update Fail	Update failed. The scheduled time has expired.

Conditions

None

Feature Cross Reference

None

Program 90 : Maintenance Program

90-38 : User Programming Data Level Setup

Level:

IN

Description

Use **Program 90-38 : User Programming Data Level Setup** sets system data to turn on/off each User Programming Feature

Item No.	Item	Input Data	Default	Description
01	Time setting	0 = Off 1 = On	1	
02	Change of music on hold tone	0 = Off 1 = On	1	
03	Automatic Night Service Pattern	0 = Off 1 = On	1	
04	Weekly Night Service Switching	0 = Off 1 = On	1	
05	Text Data for Night Mode	0 = Off 1 = On	1	
06	Holiday Night Service Switching	0 = Off 1 = On	1	
07	DISA User ID Setup	0 = Off 1 = On	1	
08	Mail Box Setup	0 = Off 1 = On	1	
09	Text Messages Setup	0 = Off 1 = On	1	
10	Incoming Ring Group Setup	0 = Off 1 = On	1	
11	Abbreviated Dial Number and Name	0 = Off 1 = On	1	
12	Night-mode switching Other Group	0 = Off 1 = On	1	
13	DSS Key Assignment	0 = Off 1 = On	1	

Item No.	Item	Input Data	Default	Description
14	Doorphone Ringing Assignment	0 = Off 1 = On	1	
15	Extension Numbering	0 = Off 1 = On	1	
16	Extension Name	0 = Off 1 = On	1	
17	Night-mode switching Own Group	0 = Off 1 = On	1	
18	Call Forward-Immediate/No Answer/Both Ring	0 = Off 1 = On	1	
19	Call Forward-Busy	0 = Off 1 = On	1	
20	Trunk Incoming Ring Tone	0 = Off 1 = On	1	
21	Internal Incoming Ring Tone (PRG15-02-03)	0 = Off 1 = On	1	
22	Display Language Selection (PRG15-02-01)	0 = Off 1 = On	1	
23	Toll Restriction Override Password (PRG21-07)	0 = Off 1 = On	1	
24	User Programming Password (PRG90-28)	0 = Off 1 = On	1	
25	Programmable Function Key (PRG15-07)	0 = Off 1 = On	1	
26	Virtual Extension Ring Assignment (PRG15-09)	0 = Off 1 = On	1	
27	One Touch Key Assignment (PRG15-14)	0 = Off 1 = On	1	
28	Trunk Name (PRG14-01)	0 = Off 1 = On	1	
29	Automatic Transfer per Trunk (PRG11-10-6,7)	0 = Off 1 = On	1	
30	SPD Area No. (PRG24-04)	0 = Off 1 = On	1	

Item No.	Item	Input Data	Default	Description
31	Telephone Data Copy	0 = Off 1 = On	1	
32	Dial in Name (PRG22-11-03)	0 = Off 1 = On	1	
33	LCD Line Key Name Assignment (PRG15-20)	0 = Off 1 = On	1	
34	IntraMail Station Mailbox Options (PRG47-02)	0 = Off 1 = On	1	

Conditions

- Switch reset is required for changes to take effect.

Feature Cross Reference

None

Program 90 : Maintenance Program

90-39 : Virtual Loop Back Port Reset

Level:
IN

Description

Use Program 90-39 : Virtual Loop Back Port Reset to reset to initial status.

(Not supported in V1000)

Input Data

Item No.	Item	Input Data
01	Virtual Loop Back Reset	[Reset?] : Dial 1+ press Transfer (Press Transfer to cancel.)

Conditions

None

Feature Cross Reference

None

Program 90 : Maintenance Program

90-41 : Server Setting to Update Terminal Local Data

Level:

IN

Description

Use **Program 90-41 : Server Setting to Update Terminal Local Data** to define the Primary DNS Server address, the Secondary DNS Server address and the Data Roaming Server address.

Input Data

Server Information	1~13
--------------------	------

Item No.	Item	Input Data	Default
01	Server Address Type	0 = IPv4 1 = IPv6	0
02	Server Address	IPv4 form (xxx.xxx.xxx.xxx) IPv6 form (xxxx : xxxx : xxxx : xxxx : xxxx)	-
03	Port Number	0~65535	0

Conditions

None

Feature Cross Reference

None

Program 90 : Maintenance Program

90-42 : DT700 Multiline Terminal Version Information

Level:
IN

Description

Use **Program 90-42 : DT700 Multiline Terminal Version Information** to set the hardware version and firmware version of the DT700 MLT Terminal.

Input Data

Terminal Type	1 = ITL-**E-1D/IP-*E-1 2 = ITL-**D-1D/ITL-24BT-1D/ITL-24PA-1D 3 = ITL-320C-1
---------------	--

Item No.	Item	Input Data	Default
01	Software Version	00.00.00.00~FF.FF.FF.FF	00.00.00.00
02	Hardware Version	00.00.00.00~FF.FF.FF.FF	00.00.00.00

Conditions

None

Feature Cross Reference

None

Program 90 : Maintenance Program

90-43 : Deleting Terminal License of DT700

Level:

IN

Description

Use **Program 90-43 : Deleting Terminal License of DT700** to delete the terminal license information delivered to the DT700 terminal.

Input Data

Extension Number	Up to eight digits
------------------	--------------------

Item No.	Item	Input Data
01	Delete Terminal License	[Delete?] : Dial 1+ press Transfer (Press Transfer to cancel.)

Conditions

None

Feature Cross Reference

None

Program 90 : Maintenance Program

90-44 : Deleting Terminal License of TCP Interface

Level:
IN

Description

Use **Program 90-44 : Deleting Terminal License of TCP Interface** to delete the terminal license information delivered to the terminal with a TCP interface.

Input Data

License Delete Code	000~000~000 - 999~999~999
---------------------	---------------------------------

Item No.	Item	Input Data
01	Delete Terminal License	[Delete?] : Dial 1+ press Transfer (Press Transfer to cancel.)

Conditions

None

Feature Cross Reference

None

Program 90 : Maintenance Program

90-45 : Temporary Password Change for Multiline Telephone

Level:

IN

Description

Use **Program 90-45 : Temporary Password Change for Multiline Telephone** to change the Temporary Password that is set in the Encryption function.

Input Data

Item No.	Item	Input Data	Default
01	Temporary Password Change Request	00.00.00.00~FF.FF.FF.FF Change? (Yes :1)	00.00.00.00

Conditions

None

Feature Cross Reference

None

Program 90 : Maintenance Program

90-48 : *Button Kit Information of Multiline Telephone*

Level:
IN

Description

Use **Program 90-48 : Button Kit Information of Multiline Telephone** to set the button kit information on a new telephone on the SV8100 system.

Input Data

Extension Number	Eight digits (except virtual extension)
------------------	---

Item No.	Item	Input Data
01	Button Kit Information of Multiline Telephone	0 = No Setting 1 = Not Used 2 = Type A with Cursor Key 3~9 = Not Used 10 = Type A without Cursor Key (Retrofit) 11~12 = Not Used

Conditions

None

Feature Cross Reference

None

Program 90 : Maintenance Program

90-49 : Protection Mode Setup for Multiline Telephone

Level:

IN

Description

Use **Program 90-49 : Protection Mode Setup for Multiline Telephone** to set the protection mode of each multiline (IP) telephone.

Input Data

Extension Number	Up to eight digits
------------------	--------------------

Item No.	Item	Input Data	Default
01	Release Protection Mode	Release? (Yes : 1)	None
02	Initialize Protection Password	Initialize? (Yes : 1)	None

Conditions

None

Feature Cross Reference

None

Program 90 : Maintenance Program

90-50 : System Alarm Display Setup

Level:
IN

Description

Use **Program 90-50 : System Alarm Display Setup** to set the system alarm report display.

Input Data

Index Number	01~50
--------------	-------

Item No.	Item	Input Data	Default
01	System Alarm Display Telephone	Up to eight digits	No setting

Conditions

None

Feature Cross Reference

None

Program 90 : Maintenance Program

90-51 : Alarm Setup for Maintenance Exchange

Level:
IN

Description

Use **Program 90-51 : Alarm Setup for Maintenance Exchange** to set the day for the maintenance exchange of parts that need regular maintenance.

Input Data

System ID	0~50
-----------	------

Index	1~10
-------	------

Item No.	Item	Input Data	Default
01	Display Name	Up to 16 characters	Refer to table
02	Year	00~99	00
03	Month	01~12	00
04	Day	01~31	00

Index	Default
01	Power battery
02	Backup battery
03	Cooling fan
04~10	--- No setting ---

Conditions

None

Feature Cross Reference

None

Program 90 : Maintenance Program

90-52 : System Alarm Save

Level:

IN

Description

Use **Program 90-52 : System Alarm Save** for the system alarm output operation.

Input Data

System ID of Source System	0~50
----------------------------	------

System ID of Destination System	0~50
---------------------------------	------

Item No.	Item	Input Data	Default
01	Save All Alarm Reports	Print All? (1 = Yes)	
02	Save New Alarm Reports	Print All? (1 = Yes)	

Conditions

None

Feature Cross Reference

None

Program 90 : Maintenance Program

90-53 : System Alarm Clear

Level:
IN

Description

Use **Program 90-53 : System Alarm Clear** to clear the system alarm.

Input Data

System ID	0~50
-----------	------

Item No.	Item	Input Data	Default
01	Clear All Alarm Reports	All Clear? (1 = Yes)	

Conditions

None

Feature Cross Reference

None

Program 90 : Maintenance Program

90-54 : PC/Web Programming

Level:

IN

Description

Use **Program 90-54 : PC/Web Programming** sets parameters for PC and Web Programming.

Item No.	Item	Input Data	Default
01	<p>Web Pro TCP port number</p> <p>The port number of TCP of the Web programming of SV8100 is set. The port number of new TCP is not reflected from the Web Pro to the logout of all users of the Web Pro who is logging in the system after data is changed in the setting.</p>	1-65535	80
02	<p>PC Pro TCP port number</p> <p>The port number of TCP of the PC programming of Cygnus is set. The port number of new TCP is not reflected from the PC professional to the logout of the user of the PC professional who is logging in the system after data is changed in the setting.</p>	1-65535	8000

Conditions

None

Feature Cross Reference

None

Program 90 : Maintenance Program

90-55 : Free License Select

Level:
IN

Description

Use **Program 90-55 : Free License Select** to validate the Free License.

(This program is available only via telephone programming and not through PC Programming).

Input Data

Item No.	Item	Input Data	Default
01	Start Free License	0 = Stop 1 = Start	

Conditions

None

Feature Cross Reference

None

Program 90 : Maintenance Program

90-56 : NTP Setup

Level:
IN

Description

Use **Program 90-56 : NTP Setup** to set the NTP.

Input Data

--	--

Item No.	Item	Input Data	Default
01	NTP Synchronize	0 = No 1 = Yes	0
02	Server Address	IPv4 form: xxx.xxx.xxx.xxx IPv6 form: xxxx.xxxx.xxxx.xxxx.xxxx	No setting

Conditions

None

Feature Cross Reference

None

Program 90 : Maintenance Program

90-57 : Backup Recovery Data

Level:
IN

Description

Use **Program 90-57 : Backup Recovery Data** to backup the system data in the flash memory on the CD-CP00-US and to make the recovery data.

Input Data

Data ID	1~5
---------	-----

Item No.	Item	Input Data
01	Backup Recovery Data	[Backup?] : Dial 1+ press Transfer (Press Transfer to cancel.)

Conditions

None

Feature Cross Reference

None

Program 90 : Maintenance Program

90-58 : Restore Recovery Data

Level:

IN

Description

Use **Program 90-58 : Restore Recovery Data** to select the recovery data stored in the flash memory of the CD-CP00-US. After this command is executed, the system restarts automatically.

Input Data

Data ID	1~5
---------	-----

Item No.	Item	Input Data
01	Restore Recovery Data	[Restore & Reset?] : Dial 1+ press Transfer (Press Transfer to cancel.)

Conditions

None

Feature Cross Reference

None

Program 90 : Maintenance Program

90-59 : Delete Recovery Data

Level:
SA

Description

Use **Program 90-59 : Delete Recovery Data** to select and delete the recovery data stored in the flash memory of the CD-CP00-US.

Input Data

Data ID	1~5
---------	-----

Item No.	Item	Input Data
01	Delete Recovery Data	[Delete?] : Dial 1+ press Transfer (Press Transfer to cancel.)

Conditions

None

Feature Cross Reference

None

Program 90 : Maintenance Program

90-60 : T1/ISDN Layer Status Information

Level:
IN

Description

Use **Program 90-60 : T1/ISDN Layer Status Information** to display layer status information for T1/PRI/BRI/CD-CCTA packages.

Input Data

System ID	1~50
-----------	------

Slot No.	1~24
----------	------

Item No.	Item	Input Data	Default
01	Link Status	– = No link 0 = Link N/A = No card seen in slot	N/A

Conditions

- This Program is Read-Only.

Feature Cross Reference

None

Program 90 : Maintenance Program

90-61 : Manual Slot Install

Level:
IN

Description

Use **Program 90-61 : Manual Slot Install** to manually install any package. If another package is already assigned, the new package cannot be assigned.

Input Data

System ID	1~50
-----------	------

Slot No.	1~24
----------	------

Item No.	Item	Input Data	Default
01	Install	0 = None 1 = Router 2 = PVA-NAT	0

Conditions

None

Feature Cross Reference

None

Program 90 : Maintenance Program

90-62 : Security ID Information

Level:
IN

Description

Use **Program 90-62 : Security ID Information** to display the security ID of the CD-CP00-US.

Input Data

Item No.	Item	Display Data
01	Security ID	0~9 and A~F (32 digits or less)

Conditions

None

Feature Cross Reference

None

Program 90 : Maintenance Program

90-63 : DT700 Control

Level:
IN

Description

Use **Program 90-63 : DT700 Control** to adjust settings of the DT700.

Input Data

Item No.	Item	Input Data	Default
01	Priority Timer	0~255	80

Conditions

None

Feature Cross Reference

None

Program 90 : Maintenance Program

90-64 : SNMP Setup

Level:
IN

Description

Use **Program 90-64 : SNMP Setup** to configure the SNMP function.

Input Data

Item No.	Item	Input Data	Default
01	SNMP	0 = Disable 1 = Enable	0
02	Community Name	Max. 12 characters	Public
03	Target Host 1	XX.XX.XX.XX	0.0.0.0
04	Target Host 2	XX.XX.XX.XX	0.0.0.0
05	Target Host 3	XX.XX.XX.XX	0.0.0.0
06	Target Host 4	XX.XX.XX.XX	0.0.0.0
07	Target Host 5	XX.XX.XX.XX	0.0.0.0

Conditions

None

Feature Cross Reference

None

Program 90 : Maintenance Program

90-65 : 1st Party CTI Authentication Password Setup

Level:
IN

Description

Use **Program 90-65 : 1st Party CTI Authentication Password Setup** to set the authentication password.

Input Data

Item No.	Item	Input Data	Default
01	Password Sets the authentication password when the 1st Party CTI application is connected to the system via a NAT router. If a password is not set, the system does not certify it.	Up to 16 characters	nec-i

Conditions

None

Feature Cross Reference

None

Program 92 : Copy Program

92-01 : Copy Program

Level:
IN

Program

92

Description

(This program is available only via telephone programming and not through PC Programming).

Use **Program 92-01 : Copy Program** to copy the data for one program to another multiline terminal, port, group, or other number. Refer to the following charts to see which programs can be copied.

Input Data

Program Number	XX-XX
----------------	-------

Item No.	Item	Input Data
01	Source Number Enter the extension, trunk, group or other number from which the data is to be copied.	<input type="radio"/> For Trunk Base : Trunk Port Number 1~200 <input type="radio"/> For Trunk Group Base : Trunk Group Number 1~100 <input type="radio"/> For Extension Base : Extension Number (up to eight digits) <input type="radio"/> For Department Group Base : Department Group Number 1~64 <input type="radio"/> For DSS : DSS Console Number 1~32
	Destination Number (From) Enter the first extension, trunk, group or other number to which the information is to be copied.	
	Destination Number (To) Enter the last extension, trunk, group or other number to which the information is to be copied. If the information is being copied only to one extension, trunk, group or other number, enter the information entered in the Destination Number (From) entry.	

The Copy Program is applicable only for the following programs:

Trunk Port Base

Program No.	Program Name	Note
14-01	Trunk Basic Data Setup	Copy all data except Trunk Name (Item 01).
14-02	Analog Trunk Data Setup	
14-04	Behind PBX Setup	
14-08	Music on Hold Source for Trunks	
14-09	Conversation Recording Destination for Trunk	
21-03	Trunk Group Routing for Trunks	
21-12	ISDN Calling Party Number Setup for Trunk	
21-21	Toll Restriction for Trunks	
21-22	CO Message Waiting Indication	
22-02	Incoming Service Type Setup	
22-03	Trunk Ring Tone Setup	
22-05	IRG Assignment for Normal Ring Trunk	
22-08	Second IRG Setup for Unanswered DIL / IRG	
31-05	Incoming Ring Tone Audible on External Speaker	

Trunk Group Base

Program No.	Program Name	Note
35-03	SMDR Port Assignment for Trunk Group	

Extension Base

Program No.	Program Name	Note
15-01	Extension Basic Data Setup (include Virtual Extension)	Copy all data except extension name (item 01).
15-02	Multiline Telephone Basic Data Setup	
15-03	Single Line Telephone Basic Data Setup	

Program No.	Program Name	Note
15-06	Trunk Access Map for Extension	
15-07	Programmable Function Key	
15-08	Incoming Virtual Extension Ring Tone Setup	
15-09	Virtual Extension Ring Assignment	
15-10	Incoming Virtual Extension Ring Tone Order Setup	
15-11	Virtual Extension Delayed Ring Assignment	
15-12	Conversation Recording Destination for Extension	
15-17	CO Message Waiting Indication	
15-18	Virtual Extension Key Enhancement Options	
15-20	LCD Line Key Name Assignment	
15-25	DESI-less Page Setup	
20-06	Class of Service for Extension	
20-29	Timer Class for Extension	
21-02	Trunk Group Routing for Extensions	
21-04	Toll Restriction Class for Extensions	
21-11	Hotline Assignment	
23-02	Call Pickup Groups	
23-03	Ringling Line Preference	
23-04	Ringling Line Preference for Virtual Extensions	
24-03	Park Group Assignment	
31-02	Internal Paging Group Assignment	
82-14	Handset/Headset Gain for Multiline Telephone	

Department Group Base

Program No.	Program Name	Note
16-01	Department (Extension) Group Basic Data Setup	Copy all data except Group Name (Item 01).
35-04	SMDR Port Assignment for Department Group	

DSS Console Base

Program No.	Program Name	Note
30-01	DSS Console Operation Mode	
30-03	DSS Key Assignment	

Door Box Base

Program No.	Program Name	Note
32-02	Door Box Ring Assignment	

Conditions

- Using this program to copy a multiline terminal Programmable Function Keys, copies all keys whether or not they exist on the terminal to which the programming is being copied. This may cause confusion when trying to define a key which is already defined but which does not exist on the terminal (displays as DUPLICATE DATA). It is recommend to either clear these non-existent keys or copy only from an extension which has the same or fewer number of keys than the extension to which the programming is being copied.

Feature Cross Reference

None

Program 92 : Copy Program

92-02 : Delete All Extension Numbers

Level:
IN

Description

(This program is available only via telephone programming and not through PC Programming).

Use **Program 92-02 : Delete All Extension Numbers** to delete all extension numbers. However, the extension number of the first port is not deleted.

Input Data

Extension No. Delete Yes: 1	[Dial 1] + Transfer key (Only press Transfer key is canceled)
-----------------------------	---

Conditions

None

Feature Cross Reference

None

Program 92 : Copy Program

92-03 : Copy Program by Port Number

Level:
IN

Description

(This program is available only via telephone programming and not through PC Programming).

Use **Program 92-03 : Copy Program by Port Number** to copy extension and the data of each outside line.

Input Data

Item No.	Item	Input Data
01	Source Number	Enter the port number from where the data is to be copied.
02	Destination Number (From)	Enter the first port number where the information is to be copied.
03	Destination Number (To)	Enter the last port number where the information is to be copied. If the information is to be copied only to one port, enter the information entered in the Destination Number (From) entry.

Conditions

None

Feature Cross Reference

None

Program 92 : Copy Program

92-04 : Extension Data Swap

Level:
IN

Description

(This program is available only via telephone programming and not through PC Programming).

Use **Program 92-04 : Extension Data Swap** to swap data between two extensions.

Input Data

Item No.	Item	Input Data
01	1st Extension Number	Up to eight characters.
02	2nd Extension Number	

The following table lists Programs that use the Extension Data Swap function.

Program Number	Program Name
11-02	Extension Numbering
12-05	Night Mode Group Assignment for Extensions
13-03	Abbreviated Dial Group Assignment for Extensions
13-06	Station Abbreviated Dial Number and Name
15-01	Extension Basic Data Setup
15-02	Multi-Line Telephone Basic Data Setup
15-03	Single Line Telephone Basic Data Setup
15-06	Trunk Access Map for Extension
15-07	Programmable Function Key
15-08	Incoming Virtual Extension Ring Tone Setup
15-09	Virtual Extension Ring Assignment
15-10	Incoming Virtual Extension Ring Tone Order Setup
15-11	Virtual Extension Delayed Ring Assignment

Program Number	Program Name
15-12	Conversation Recording Destination for Extension
15-13	Loop Key Data
15-14	Programming One-Touch Keys
15-17	CO-Message Waiting Indication
15-18	Virtual Extension Key Enhance Options
15-19	System Telephone book Setup for Extension
15-20	LCD Line Key Name Assignment
15-25	DESI-less Page Setup
16-02	Department Group Assignment for Extensions
20-06	Class of Service for Extension
20-29	Timer Class for Extensions
21-02	Trunk Group Routing for Extension
21-04	Toll Restriction Class for Extension
21-07	Toll Restriction Override Password Setup
21-10	Dial Block Restriction Class per Extensions
21-11	Hotline Assignment
21-13	ISDN Calling Party Number Setup for Extension
21-15	Individual Trunk Group Routing for Extensions
21-18	IP Trunk (H.323) Calling Party Number Setup for Extension
21-19	IP Trunk (SIP) Calling Party Number Setup for Extension
21-20	SIP Trunk Call Discernment Setup for Extension
21-23	Out Going Key Sized Virtual Extension Priority Setup
22-04	Incoming Ring Group Setup
22-06	Normal Incoming Ring Mode
23-02	Call Pickup Group
23-03	Ringing Line Preference
23-04	Ringing Line Preference of Virtual Extension
24-03	Park Hold Group Assignment
24-06	Fixed Call Forward
24-07	Fixed Call Forward Off-Premise

Program Number	Program Name
24-08	Call Forward for Centrex
24-09	Call Forward Split Settings
26-04	ARS Class of Service
26-07	LCR Cost Center Code Table
31-02	Internal Paging Group Assignment
41-02	ACD Agent Extension Assignment for ACD Group
41-17	ACD Login Mode Setup
42-02	Hotel Extension Basic Data Setup
43-33	Print Table for Extension
43-37	Fixed Call Restrict Table Setup
82-14	MLT Handset/Headset Gain Control
90-28	User Programming Programming Password Setup
92-05	Data Swap Password of each Extension Setup

Conditions

None

Feature Cross Reference

None

Program 92 : Copy Program

92-05 : Extension Data Swap Password

Level:
IN

Description

Use **Program 92-05 : Extension Data Swap Password** to define the 4-digit password for each extension to allow Extension Data Swap.

Input Data

Item No.	Item	Input Data	Related Programming
01	Password Password required per station when using the station swap feature.	Fixed four digits (No setting at default)	11-15-12

Conditions

None

Feature Cross Reference

None

Program 92 : Copy Program

92-06 : Fill Command

Level:
IN

Description

Use **Program 92-06 : Fill Command** to allocate the data of each extension number of each extension group or each table.

Input Data

Program Number	XX-XX
----------------	-------

Item No.	Item	Input Data
01	Source Number	Each extension port = 1~512 (PGM 11-02)
02	Destination Number (From)	Each virtual extension port = 1~256 (PGM 11-04)
03	Destination Number (To)	Each ACI port number = 1~96 (PGM 11-06)
		Each extension group = 1~64 (PGM 11-07)
		Each ACI group = 1~64 (PGM 11-08)
		Each ACD group = 1~64 (PGM 11-17)

The following table lists Programs that use the Fill Command function.

Program Number	Program Name
11-02	Extension Numbering
11-04	Virtual Extension Numbering
11-06	ACI Extension Numbering
11-07	Extension (Department) Group Pilot Number
11-08	ACI Group Pilot Number
11-17	ACD Group Pilot Number

Conditions

None

Feature Cross Reference

None

Program 92 : Copy Program

92-07 : Delete Command

Level:
IN

Description

Use **Program 92-07 : Delete Command** to delete the data of each extension number of each extension group or each table.

Input Data

Program Number	XX-XX
----------------	-------

Item No.	Item	Input Data
01	Destination Number (From)	Each extension port = 1~512 (PGM 11-02) Each virtual extension port = 1~256 (PGM 11-04) Each ACI port number = 1~96 (PGM 11-06) Each extension group = 1~64 (PGM 11-07) Each ACI group = 1~64 (PGM 11-08) Each ACD group = 1~64 (PGM 11-17)
02	Destination Number (To)	

The following table lists Programs that use the Delete Command function.

Program Number	Program Name
11-02	Extension Numbering
11-04	Virtual Extension Numbering
11-06	ACI Extension Numbering
11-07	Extension (Department) Group Pilot Number
11-08	ACI Group Pilot Number
11-17	ACD Group Pilot Number

Conditions

None

Feature Cross Reference

None

UNIVERGE[®] SV8100

PROGRAMMING MANUAL

NEC Unified Solutions, Inc.

Issue 4.0
(Version 3000)

